

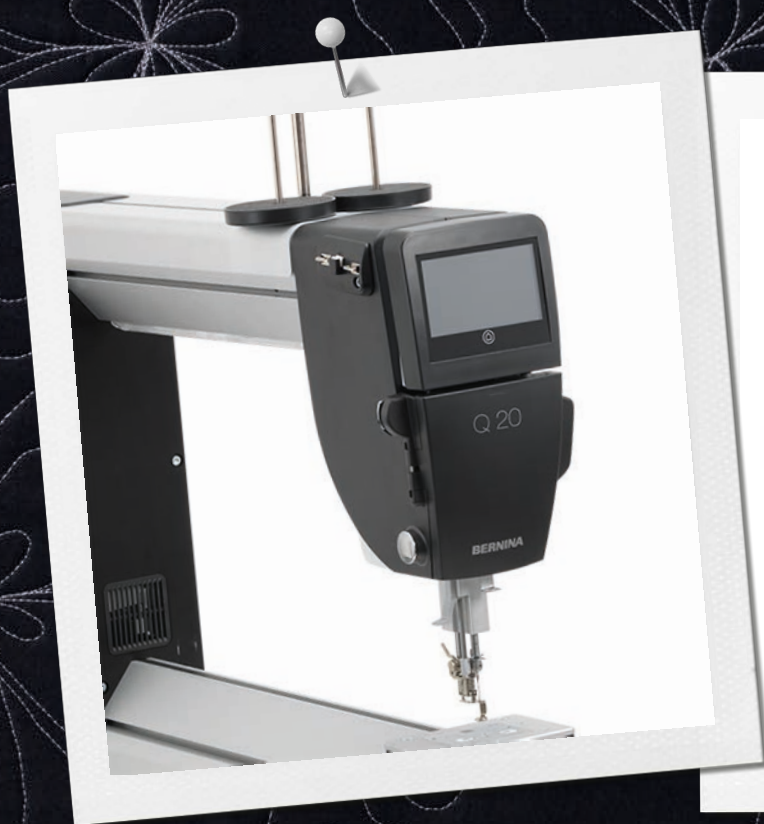

BERNINA Q 20

User manual



Dear BERNINA customer,



Congratulations! You have decided on BERNINA and therefore on a product which will delight you for years. For more than 100 years our family company has attached greatest importance to satisfied customers. It is my personal goal to offer you Swiss innovation and precision at the highest level of perfection, future-oriented sewing technology and comprehensive customer service.

The machines from the BERNINA Q Series are state-of-the-art models, and, in addition to the strictest requirements of technology and user-friendliness, product design was also at the forefront of their development. After all we sell our products to creative people like you, who do not only appreciate high quality but also form and design.

Enjoy creative quilting with your new BERNINA Q 20 and find out about the variety of accessories at www.bernina.com. On our homepage, you can also find many inspiring sewing and quilting ideas.

Our highly trained BERNINA dealers will provide you with more information on service and maintenance offers.

I hope that you have great fun and plenty of time for creativity with your new BERNINA Longarm.

A handwritten signature in black ink that reads "H.P. Ueltschi". The signature is written in a cursive, flowing style.

H.P. Ueltschi

Owner

BERNINA International AG

CH-8266 Steckborn



Table of Contents

IMPORTANT SAFETY INSTRUCTIONS	6	2.7 Bobbin thread	31
Important information	8	Winding the bobbin	31
1 My BERNINA	10	Threading the bobbin thread	33
1.1 Introduction	10	Setting the bobbin thread tension	34
1.2 Welcome to the world of BERNINA	10	Inserting the bobbin case	36
1.3 Machine	12	Fill level of bobbin thread	36
Overview, front left	12	2.8 Upper thread	37
Overview, front right	13	Threading preparation	37
Overview, rear right	14	Threading the upper thread	37
1.4 Provided accessories	15	Threading the twin needle	41
1.5 Software	16	3 Settings	46
Software operation	16	3.1 Overview Setup-Program	46
Home screen	19	3.2 Selecting the language	46
Sewing screen	19	3.3 Setting up the screen	47
Calling up the Help	20	Personalizing the screen	47
Calling up the Tutorial	20	Adjusting the screen brightness	48
Using the eco mode	20	3.4 Adjusting the sewing light	48
Using the calculator	21	3.5 Setting sounds	49
Resetting the stitch counter	21	3.6 Adjusting the needle laser pointer	50
2 Setting up the machine	22	3.7 Setting up monitoring functions	50
2.1 Connection and Switching on	22	3.8 Setting the securing stitches	51
Connecting the machine	22	3.9 Adjusting the upper thread tension	51
Switching the machine on and off	22	3.10 Managing user profiles	51
2.2 Attaching the spool holder	22	3.11 Selecting a user profile	53
2.3 Foot control	24	3.12 Quilting modes	53
Attaching the foot control	24	3.13 Displaying the total number of stitches	54
Programming the back kick	24	3.14 Registering details of the dealer	54
Using the single stitch/securing function with the foot control	25	3.15 Saving Service data	55
Using the KickSstart function	25	3.16 Restoring factory settings	55
2.4 Programming the handle buttons	26	4 Tips for problem-free quilting	57
Using the single stitch/securing function with the handles	28	4.1 Fabric	57
2.5 Presser foot	28	4.2 Thread	57
Raising and lowering the presser foot	28	4.3 Needle	57
Changing the presser foot	28	4.4 Using a spool disc	58
2.6 Needle and stitch plate	29	4.5 Using a spool net	59
Adjusting the needle stop up/down	29		
Raising and lowering the needle	29		
Changing the needle	29		
Changing the stitch plate	30		



5	Preparing to work on a quilt	60
5.1	Loading the frame	60
5.2	Basting quilt layers	61
5.3	Sewing sample	61
6	Practical quilting	62
6.1	Standard procedure for quilting	62
6.2	Starting and stopping the machine	62
6.3	Controlling the speed	63
7	Care and maintenance	64
7.1	Firmware	64
	Verifying the software version	64
	Updating firmware	64
	Starting the Service Programm	65
7.2	Machine	66
	Cleaning the screen	66
	Calibrating the screen	66
	Cleaning the bobbin case	67
	Cleaning the hook	68
	Lubricating the machine	69
7.3	Quilting frame	70
	Checking and cleaning the frame	70
	Checking and cleaning the carriage	70
7.4	Quilting table	70
	Cleaning and maintenance	70
	Moving or transporting the table	70
8	Errors and faults	72
8.1	Error messages	72
8.2	Troubleshooting	74
9	Technical specifications	77
10	Storage and disposal	78
10.1	Storing the machine	78
10.2	Dispose of the machine	78
11	Appendix	79
11.1	Amount of bobbin thread	79
	Index	81



IMPORTANT SAFETY INSTRUCTIONS

Please be aware of the following basic safety instructions when using your machine. Before using this machine, read instruction manual carefully.

DANGER!

To reduce the risk of electrical shock:

- Never leave the machine unattended as long as it is plugged in.
- Always unplug the machine from the electrical outlet immediately after using.

Protection against LED radiation:

- Do not view the LED light directly with optical instruments (e.g. magnifier). The LED light corresponds with protection class 1M.
- When the LED light is damaged or defective, contact your BERNINA specialist dealer.

WARNING

To reduce the risk of burns, fire, electric shock or injury to persons:

- Use this machine only for its intended use as described in this instruction manual.
- Do not use the machine outdoors.
- Do not use the machine as a toy. Increased caution is advised when the machine is used by or near children.
- This machine can be used by children over the age of eight, as well as by persons with reduced physical, sensory or mental capacities or with a lack of experience and knowledge, as long as they are supervised or have been made aware of the safe use of the machine and understand the potential hazards that might arise from it.
- Children must not play with the machine.
- Cleaning and maintenance work must not be carried out by children without supervision.
- Do not use this machine if cables or plugs are damaged, or if the machine is not working properly, has been dropped or damaged or has fallen into a pool of water. Get in touch with the nearest BERNINA specialist and agree how you will proceed further.
- Only use the accessories recommended by the manufacturer.
- Never operate this machine with any air vents blocked. Keep all air vents free of lint, dust and fabric residue.



- Do not insert any objects into the openings of the machine.
- Always use the type LV1 foot control with the BERNINA Q 20.
- Do not use the machine anywhere that oxygen or propellant products (sprays) are being used.
- Keep fingers away from all moving parts. Special care is required around the machine needle.
- When working in the needle area – such as replacing needles, threading the bobbin thread or replacing the presser foot – set the power switch to «0».
- Do not use bent needles.
- Always use an original BERNINA stitch plate. The wrong stitch plate can cause needle breakage.
- To disconnect, set the power switch to «0» and then remove the plug from the outlet. Do not unplug by pulling the cord, instead grasp the plug to pull it from the outlet.
- Remove the plug from the outlet if covers have been removed or opened, if the machine is being oiled or if other cleaning and maintenance work mentioned in this instruction manual is being carried out.
- This sewing machine is double-insulated (except in the USA and Canada). Use only original replacement parts. Note the information on maintaining double-insulated products.

Important information

Availability of the instruction manual

The instruction manual is supplied with the machine.

- Keep the instruction manual safe at a suitable place near the machine to have it at hand in case that you need to look up something.
- If you pass the machine to a third party, always include the instruction manual.

Proper use

Your BERNINA machine is conceived and designed for private household use. It is intended for quilting fabrics and other materials as described in this instruction manual. Any other use is not considered proper. BERNINA assumes no liability concerning consequences resulting from an improper use.

Equipment and scope of delivery

Example images are used in these operating instructions for the purposes of illustration. The machines shown in the images and the accessories shown therefore do not always match the actual items included with your machine. The supplied accessory can vary depending on the country of delivery. You can acquire any accessories mentioned or shown that are not included in the scope of delivery as optional accessories from a specialist BERNINA dealer. Further accessories can be found at www.bernina.com.

For technical reasons and in order to improve the product, changes may be made to the equipment of the machine and the scope of delivery at any time and without prior notice.

Maintenance of double-insulated products

In a double-insulated product, two systems of insulation are provided instead of grounding. No grounding means is provided on a double-insulated product nor should a means for grounding be added to the product. Servicing a double-insulated product requires extreme care and knowledge of the system and should only be done by qualified service personnel. Only original spare parts should be used for service and repairs. A double-insulated product is marked with the words: «Double-Insulation »or «double-insulated».

 The symbol may also be marked on the product.

Environmental Protection

BERNINA is committed to the protection of the environment. We strive to minimize the environmental impact of our products by continuously improving product design and our technology of manufacturing.



The machine is labeled with the symbol of the crossed-out wastebin. This means that the machine should not be disposed of in household waste when it is no longer needed. Improper disposal can result in dangerous substances getting into the groundwater and thus into our food chain, damaging our health.

The machine must be returned free of charge to a nearby collection point for waste electrical and electronic equipment or to a collection point for the reuse of the machine. Information on the collection points can be obtained from your local administration. When purchasing a new machine, the dealer is obliged to take back the old machine free of charge and dispose of it properly.

If the machine contains personal data, you are responsible for deleting the data yourself before returning the machine.

Explanation of symbols



Designates a high-risk hazard which can lead to serious injuries or potentially even death if not avoided.



Designates a medium-risk hazard which can lead to serious injuries if not avoided.



Designates a low-risk hazard which can lead to minor or moderate injuries if not avoided.

NOTICE

Designates a hazard which can lead to material damage if not avoided.



Tips from BERNINA **quilt experts** can be found next to this symbol.



1 My BERNINA

1.1 Introduction

Large quilting projects can be handled with your BERNINA Q 20.

In addition to this instruction manual, you can find two help programs on your machine:

- The **tutorial** gives information and explanations regarding various aspects of quilting (see page 20).
- The **help program** contains explanations of software functions seen directly on the screen (see page 20).

The accessories catalog, in which you can find further quilting accessories, is also enclosed with your machine together with this instruction manual.

You can find the latest version of your instruction manual as well as a lot more information about sewing and quilting on our website at www.bernina.com.

Because of its size, your BERNINA Q 20 must be used on a quilt frame or a special quilt table. Assembly instructions for the machine on the quilt frame or sit down table can also be found on our website www.bernina.com.

1.2 Welcome to the world of BERNINA

Made to create, this is the slogan of BERNINA. Not only with our machines do we support you in the implementation of your ideas. In addition to the offers listed below, we offer you lots of suggestions and instructions for your future projects as well as the opportunity to exchange ideas with other sewing, quilting and embroidery enthusiasts. I wish you lots of pleasure.

BERNINA YouTube Channel

On YouTube we offer a wide range of how-to videos and support concerning the most important functions of our machines. Detailed explanations are also provided as for the various presser feet, so that your projects will succeed completely.

<http://www.youtube.com/BerninaInternational>

Provided in the languages English and German.

inspiration – the sewing magazine

Are you looking for ideas and instructions for great projects? In that case the BERNINA magazine «inspiration» is exactly what you need. «inspiration» offers extraordinary sewing and embroidery ideas four times a year. From seasonal fashion trends to trendy accessories and practical tips to decorate your home in an original way.

<http://www.bernina.com/inspiration>

The magazine is available in the languages English, German, Dutch and French. Not available in all countries.

BERNINA Blog

Fancy instructions, free sewing patterns and embroidery motifs as well as many new ideas: all this you can find in the weekly blog by BERNINA. Our experts give valuable tips and explain step by step how you can achieve the desired result. In the community you can upload your own projects and exchange experiences and ideas with other sewing and embroidering enthusiasts.

<http://www.bernina.com/blog>

Provided in the languages English, German and Dutch.



BERNINA Social Media

Follow us on the social networking to learn more about events, thrilling projects as well as tips and tricks all about sewing, quilting and embroidering. We will keep you informed and we are looking forward to presenting you the one or the other highlight from the world of BERNINA.

<http://www.bernina.com/social-media>



1.3 Machine

Overview, front left

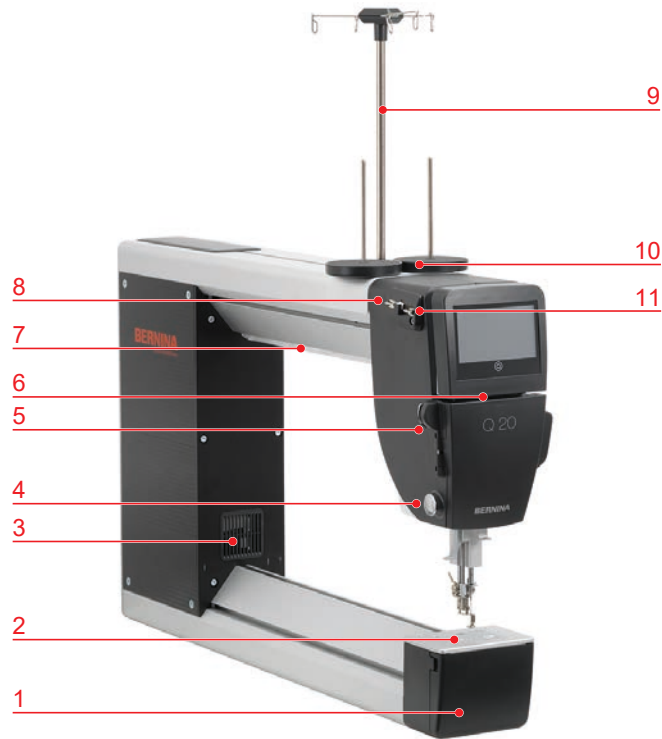

- | | | | |
|---|----------------------|----|--------------------------------|
| 1 | Hook cover | 7 | Sewing light |
| 2 | Stitch plate | 8 | Thread guide, top, left |
| 3 | Air vents | 9 | Thread guide rod, with eyelets |
| 4 | Thread cutter | 10 | Thread stand |
| 5 | Thread guide, bottom | 11 | Thread guide, top, right |
| 6 | Thread guide slot | | |

Overview, front right

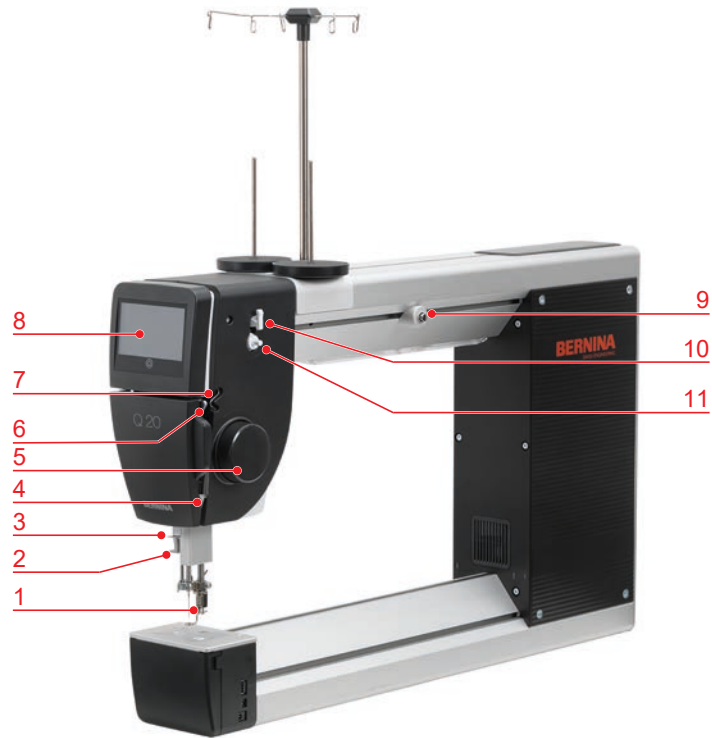

- | | | | |
|---|----------------------|----|---------------------|
| 1 | Presser foot | 7 | Thread guide |
| 2 | Needle threader | 8 | Screen |
| 3 | Thread guide | 9 | Thread pre-tension |
| 4 | Thread regulator | 10 | Thread cutter |
| 5 | Handwheel, front | 11 | Bobbin winding unit |
| 6 | Thread take-up lever | | |



Overview, rear right

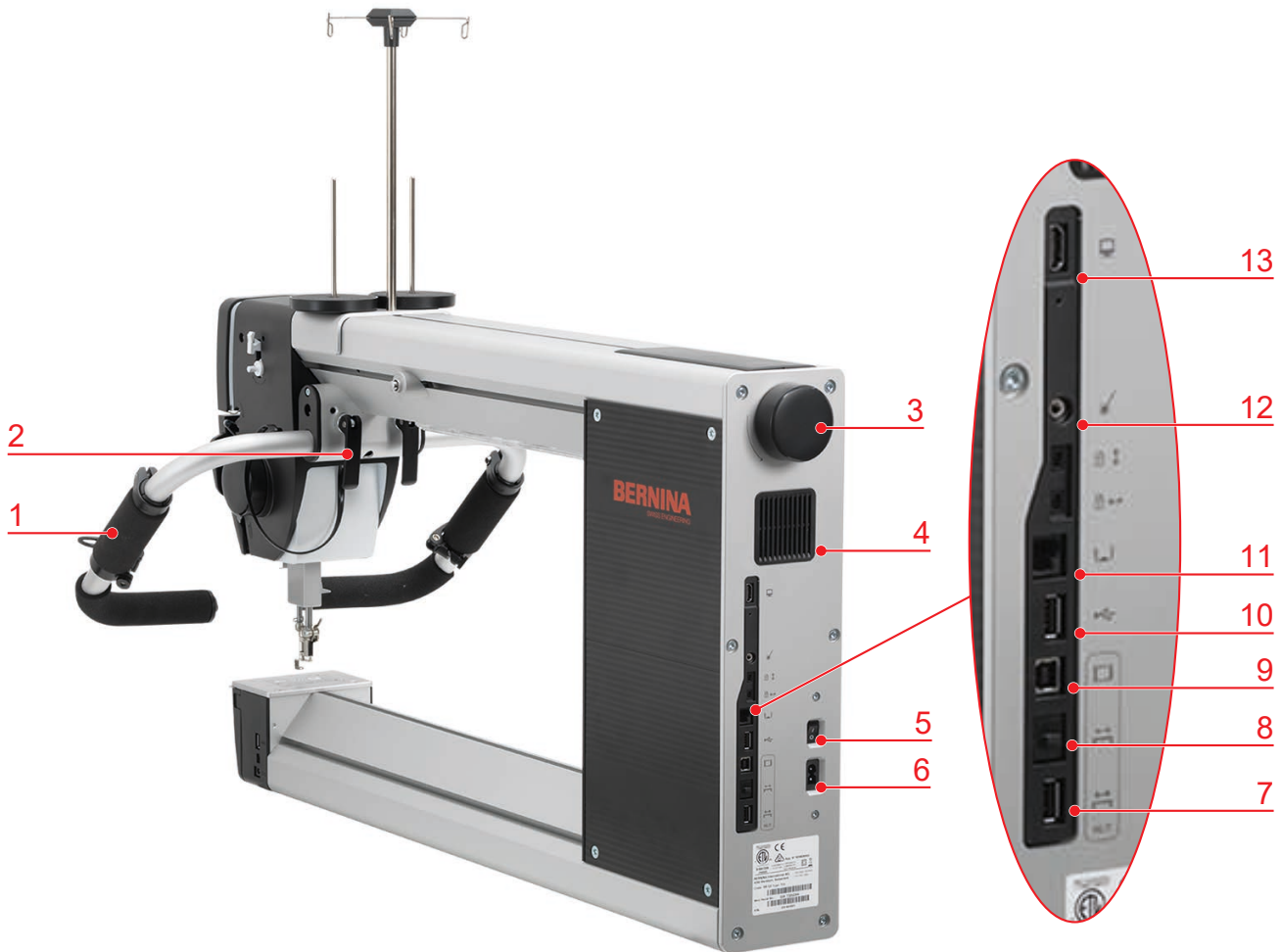

- | | | | |
|---|--|----|---------------------------|
| 1 | Handle (Q 20 frame model only) | 8 | Connection, automation |
| 2 | Locking lever, Handle (frame model only) | 9 | Connection, control unit |
| 3 | Handwheel, rear | 10 | Connection, USB cable |
| 4 | Air vents | 11 | Connection, handle, rear |
| 5 | Power switch | 12 | Connection, laser pointer |
| 6 | Connection, power cable | 13 | Connection, screen, rear |
| 7 | Connection, automation | | |

1.4 Provided accessories























Illustration	Name	Purpose
	Accessories box	To store the supplied accessories as well as the optional accessories.
	Darning Foot #9	For free motion quilting and repairing holes. For free motion embroidery and contour quilting.
	Thread lubrication unit	To improve stitch quality when working with metallic threads and using adhesive sprays or iron-on batting.
	Silicone oil	To fill the thread lubrication unit.
	Spool disc	To support the regular unwinding of the thread from the spool. To fix small spools onto the vertical spool pin.
	Bobbin 6 pieces, 1 in the machine	To wind the bobbin thread.
	Spool stabilizer 2 pieces	For giving large spools better hold on the vertical spool pin. To avoid vibrations from the spool.
	Seam ripper	To undo seams.
	Spool net	For evenly drawing off thread from large spools.
	130/705 H PRO 100 needles Set of 5.	For any common applications.

Illustration	Name	Purpose
	Manual threader	To thread the double needle.
	Screwdriver, red	To adjust the thread tension of the bobbin.
	Screwdriver, hexagon	To change the needle.
	Torx T25 screwdriver	For installing the spool pin.
	Screwdriver set, Torx	For fitting the machine to the quilt frame.
	Brush	For cleaning the hook area.
	Microfiber cleaning cloth	For cleaning the screen.
	Grub screw (replacement)	For securing the needle.
	Sewing machine oil	To oil the machine.
	Bobbin thread tension gauge	For measuring and adjusting the bobbin thread tension.
	Power cable	To connect the machine with the power supply system.
	Foot control	To start and stop the machine. To control the sewing speed in manual mode.

1.5 Software







Software operation

The touch-sensitive screen can be operated with the finger or stylus.



Tap: Short tap of an element.

Draw: Tap the screen and slowly move in one direction, eg. for scrolling up and down.

Navigation

Illustration	Name	Purpose
	«Home»	Switch between «Home screen» and «Sewing screen».
	Navigation path	Show a previous menu level.
	«Close»	Close the window.
	More	Show more features or information.
	Continue	Scroll to next display.
	Back	Scroll to previous display.

Activate/deactivate functions

Figure	Element	Status
	Switch	Function is activated.
		Function is deactivated.



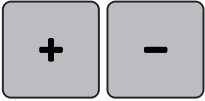
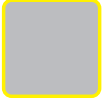



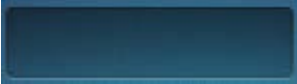

Adjust values

Illustration	Name	Purpose
	Slider control	Set the value with the slider control. Reset the value to the default value by tapping the small bullet.
	Field «Plus» / «Minus»	«Plus» increase, «Minus» reduce the value.
	Yellow frame	Indication that the set value differs from the default value. Reset the value to the default value by tapping.

Enter text and numbers

To enter numerical values or text, a corresponding keyboard is shown.



Illustration	Name	Purpose
	Entry field	Display of the entry. Delete all characters entered with a single tap.
	«Deleting»	Delete the last character.
	«Lower case characters»	Show the available letters in lower case letters.
	«Upper case characters»	Show the available letters in upper case letters.
	«Numbers and mathematical characters»	Show the available numbers and mathematical characters.
	«Special characters»	Show the available special characters.
	«Confirm»	Confirm the entry and leave the submenu.
	«Cancel»	Cancel the entry and the view closes.

Home screen

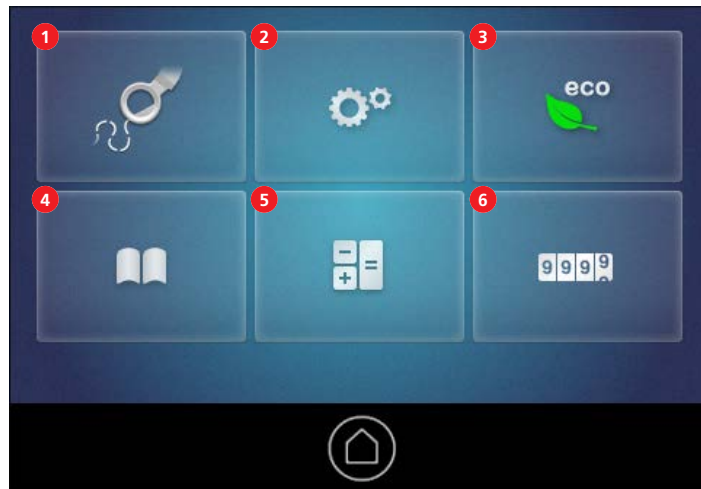

- | | | | |
|---|-----------------|---|------------------|
| 1 | «Sewing screen» | 4 | «Tutorial» |
| 2 | «Setup Program» | 5 | «Calculator» |
| 3 | «eco-mode» | 6 | «Stitch counter» |

Sewing screen

Sewing screen (Frame model)

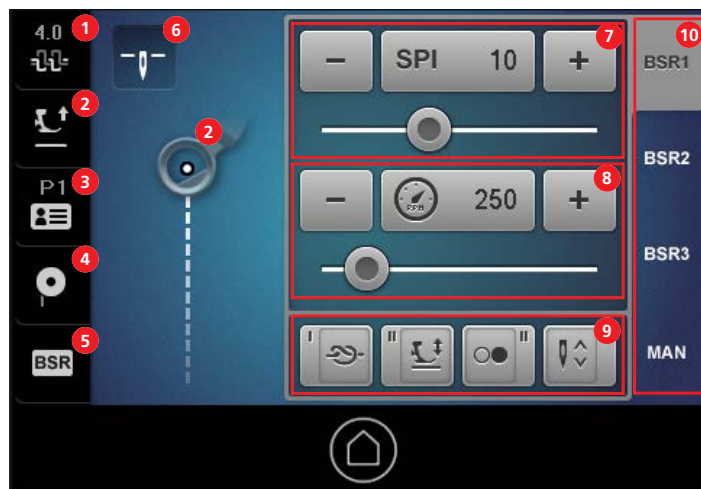

- | | | | |
|---|-------------------------------------|----|--------------------------|
| 1 | «Upper thread tension» | 6 | «Needle stop up/down» |
| 2 | «Raising/lowering the presser foot» | 7 | «Stitches» |
| 3 | «User profile» | 8 | «Idle speed» |
| 4 | «Bobbin filling» | 9 | «Programmable functions» |
| 5 | «BSR» | 10 | «Quilting modes» |

Sewing screen (Sit down model)

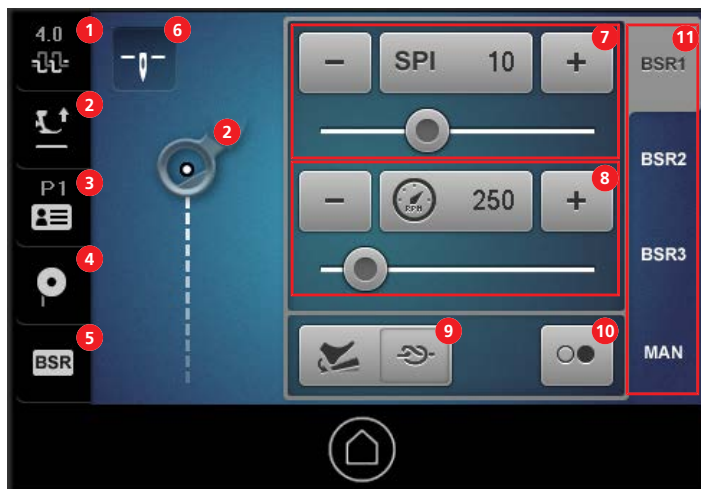

- | | | | |
|---|-------------------------------------|----|--------------------------|
| 1 | «Upper thread tension» | 7 | «Stitches» |
| 2 | «Raising/lowering the presser foot» | 8 | «Idle speed» |
| 3 | «User profile» | 9 | «Programmable functions» |
| 4 | «Bobbin filling» | 10 | «KickStart»function |
| 5 | «BSR» | 11 | «Quilting modes» |
| 6 | «Needle stop up/down» | | |

Calling up the Help

The help contains information about a selected object on the screen.



- > Tap the window or function for which help is required.
- > Double tap «Home».
- > Tap the object for which help is required.
 - Help for the selected object will be displayed.

Calling up the Tutorial

The tutorial provides information and explanations about different areas of quilting, and the machine.



- > Tap «Home».



- > Tap «Tutorial».
- > Select the required topic.
- > Scroll longer texts upwards.

Using the eco mode

If work is interrupted for an extended period, the machine can be put into energy-saving mode. The screen will be locked and the machine cannot be started.



- > Tap «Home».

- > Tap «eco-mode».
 - The screen and sewing light will switch off.

- > To exit energy-saving mode, tap «Home».
 - The machine is ready for use.

Using the calculator

The calculator can be used for various calculations.

- > Tap «Home».

- > Tap «Calculator».
 - A calculator with standard functions will be displayed.

Resetting the stitch counter

With the stitch counter, you can count the number of stitches per quilting project.

- > Tap «Home».

- > Tap «Stitch counter».
 - The number of stitches sewn will be displayed.

- > To reset the stitch count to zero, tap «Reset».

2 Setting up the machine

2.1 Connection and Switching on

Connecting the machine

- > Insert the device connector of the power cable into the machine's power cable connection.
- > Insert the power plug of the power cable into the socket.

For USA/Canada only

The machine has a polarized power plug (one contact is wider than the other). To reduce the risk of electric shock, the power plug can only be plugged into the socket in one way. If the power plug does not fit into the socket, turn the power plug over. If the turned-over power plug still does not fit, have an appropriate power socket installed. Contact your electrician. Do not modify the power plug in any way.

Switching the machine on and off

- > To switch the machine on, set the main switch to «I».
- > To switch the machine off, set the main switch to «O».

2.2 Attaching the spool holder

Required parts and tools:

- Spool pin
 - Thread eyelet attachment
 - Torx T25 screwdriver
- > Fit the attachment with the thread eyelets into the slot of the thread guide such that the arm with the two thread eyelets (1) is positioned above the left spool pin (2).

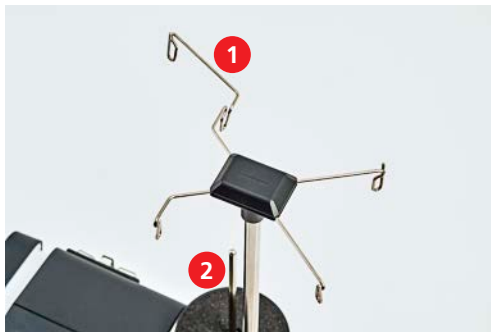

- > Turn the screw between the spool pins such that the nut (1) can be inserted into the groove.

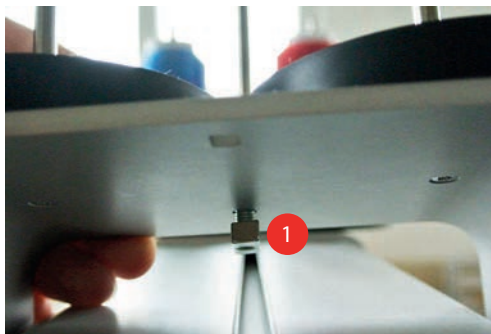

- > Place the spool holder on the machine such that both spool pins (1) are positioned in front of the thread guide (2).

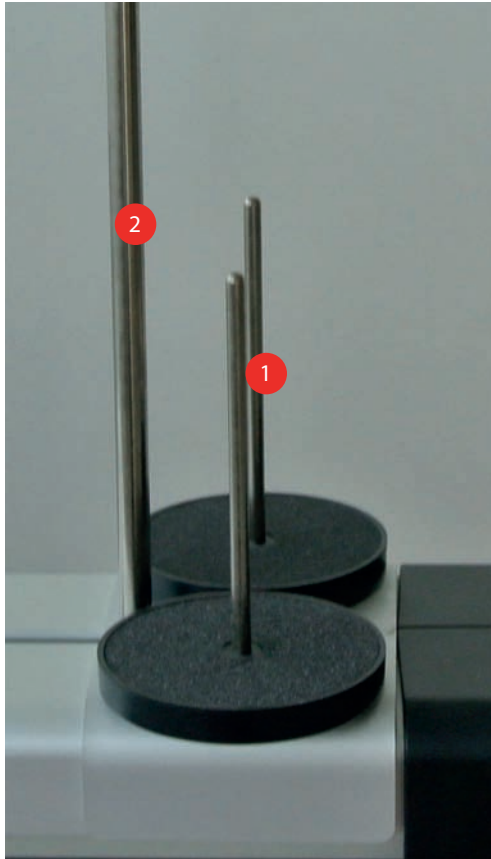

- > Slide the spool pin forward until it lies against the machine housing.
- > Tighten the screw (1).



2.3 Foot control

NOTICE! For sit down model only

Attaching the foot control

- > Unwind the cable of the foot control to the desired length.



- > Insert the cable of the foot control into the connection (1).



- > Place the foot control under the table.

Programming the back kick

The back kick of the foot control can be programmed with functions such as «Raising/lowering the needle», «Raising/lowering the presser foot» or «Single stitch/securing».

- > Switch on the machine and wait until it starts up.
- > Tap «Programmable functions».

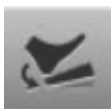

- > Select the required function for the back kick.



- | | | | |
|---|--------------------------|---|-------------------------------------|
| 1 | «No function» | 3 | «Raising/lowering the needle» |
| 2 | «Single stitch/securing» | 4 | «Raising/lowering the presser foot» |



- > Close the window.
- The function will be programmed. With each back kick on the foot control, the selected function will be carried out.

Using the single stitch/securing function with the foot control



The «Single stitch/securing» function combines the following functions:

- Pull the bobbin thread upward with a single stitch.
- Sew a programmed number of securing stitches.

Prerequisite:

- The back kick is programmed with «Single stitch/securing». (see page 24)
- > To pull the bobbin thread up with a single stitch, briefly tap the foot control with your heel.
- > To sew the programmed number of securing stitches, press the foot control down with your heel until the programmed securing stitches have been stitched.

Using the KickStart function

The KickStart function enables quilting without keeping the foot control pressed.

- > In the sewing screen, select the desired mode, e.g. BSR1, and set the desired values, e.g. stitch length, idle speed. (see page 19)



- > To activate the KickStart function, tap. «KickStart»
 - The KickStart screen appears. The selected quilting mode will be displayed.

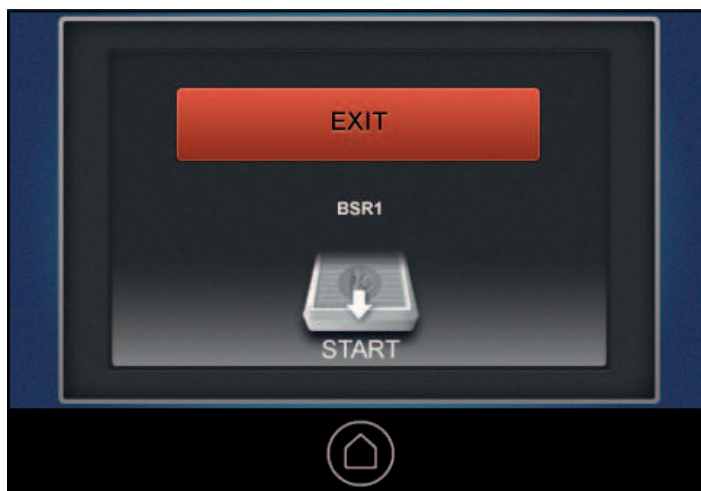

- > To start the machine, press the foot control **briefly** with your heel.
 - If a BSR mode has been selected, the machine will start sewing using the selected settings as soon as the fabric is moved.
 - If manual mode has been selected, the machine will start sewing immediately.
- > To stop the machine, press the foot control briefly with your heel again.
 - The machine will stop, but KickStart function will remain active.
- > To end KickStart function, touch the screen or press the foot control down at the front.
 - The sewing screen will be displayed.
 - The KickStart function will be deactivated.
 - The function programmed for the back kick will be active.

Please note

- As long as the KickStart function is active, the function programmed for the back kick will be deactivated. The back kick then serves only to start and stop the machine.
- The KickStart function will be ended immediately in case the active monitoring function reports an error (e.g. thread break or bobbin empty).
- The KickStart function will be ended immediately in case the foot control cable is unplugged.
- If no sewing is being carried out in the BSR modes, the machine will switch to standby mode after seven seconds. This means that the machine will not start sewing automatically if the fabric is moved. End standby mode with another back kick.
- If no sewing has been carried out for 60 seconds, the kick-start function will be ended automatically. The KickStart screen will disappear.

2.4 Programming the handle buttons

NOTICE! For Frame model only

There are 2 buttons on each handle that can be programmed with different functions.

- > Switch on the machine and wait until it starts up.
- > To program the buttons, repeat the following steps for all buttons.



> Tap one of the 4 programmable buttons on the sewing screen.

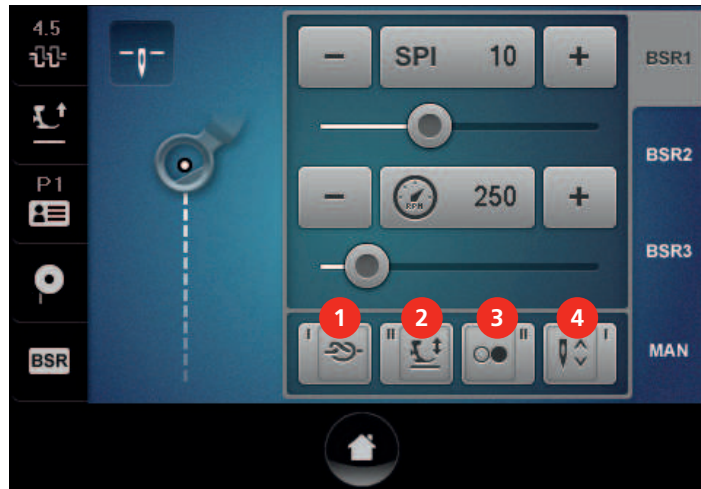

- | | |
|--------------------------|---------------------------|
| 1 Button I, left handle | 3 Button II, right handle |
| 2 Button II, left handle | 4 Button I, right handle |

> Select the desired function for the button.



- | | |
|---------------------------------------|---|
| 1 «No function» | 5 «Raising/lowering the presser foot» |
| 2 «Starting and stopping the machine» | 6 «Reducing stitching speed» |
| 3 «Single stitch/securing» | 7 «Increasing stitching speed» |
| 4 «Raising/lowering the needle» | 8 «Needle laser pointer on/off» (only if the needle laser pointer is connected and activated) |



> Close the window.

Using the single stitch/securing function with the handles



The «Single stitch/securing» function combines the following functions:



- Pull the bobbin thread upward with a single stitch.
- Sew a programmed number of securing stitches.

Prerequisite:

- A button of the handles is programmed with «Single stitch/securing». (see page 26)
- > To pull the bobbin thread up with a single stitch, briefly press down the button programmed with the function.
- > To sew the programmed number of securing stitches, press down the button programmed with the function until the programmed securing stitches have been stitched.

2.5 Presser foot

Raising and lowering the presser foot

On the sewing screen	With handle button (Frame model)	With foot control (Sit down model)
 or  or  Tap.	Press the button programmed with «Raising/lowering the presser foot». (see page 26)	With back kick, if the back-kick function is programmed with «Raising/lowering the presser foot». (see page 24)

Changing the presser foot

- > Raise the needle.
- > Raise the presser foot.
- > Switch the machine off.
- > Raise the clamping lever.





- > Pull the presser foot away in a downward direction.
- > Insert a new presser foot into the bracket from below.
- > Press the clamping lever down.

2.6 Needle and stitch plate

Adjusting the needle stop up/down

You can adjust the position in which the needle should be when the machine stops with «Needle stop up/down».

> To alter the needle stop position, tap «Needle stop up/down».

Display	Needle stop position
	Needle stops up.
	Needle stops down.

Raising and lowering the needle

With handle button (Frame model)

Prerequisite:

- One handle button is programmed with «Raising/lowering the needle». (see page 26)
- > To raise or lower the needle, press the handle button programmed with. «Raising/lowering the needle»

With foot control (Sit down model)

Prerequisite:

- The back kick can be programmed with the «Raising/lowering the needle» function. (see page 24)
- > To raise or lower the needle, press the foot control downward with your heel.

With handwheel

> To raise or lower the needle, press the handwheel against the machine and turn.

Changing the needle

With longarm quilting, a huge number of stitches are sewn in a short period of time and the needle wears out quickly. This is why you must replace the needle regularly. Insert a new needle at least before each new quilting project, because only a perfect point results in a clean stitch.

Required parts and tools:

- Screwdriver, hexagon
- > Raise the needle.
 > Lower or remove the presser foot.
 > Switch the machine off.

- > Loosen the fixing screw.



- > Pull the needle away in a downward direction.
- > Insert the new needle with the flat side to the rear.
- > Slide the needle upwards as far as it will go.
- > Tighten the fixing screw.

Changing the stitch plate

Replace the stitch plate in the following cases:

- If you want to work with a double needle.
- If the stitch plate is damaged.
- > Switch the machine off.
- > Remove the presser foot.
- > Remove the needle.
- > At the marking on the upper right corner of the stitch plate, push the stitch plate downwards until it tips.



- > Remove the stitch plate.
- > Place the new stitch plate such that both openings are positioned above the BSR sensors.
- > Press the stitch plate down until it clicks into position.



2.7 Bobbin thread

Winding the bobbin

- > Place the empty bobbin on the spool axis such that the BERNINA label on the bobbin is **not** visible.
- > Place the spool on the right spool pin.
- > Insert the thread first in the eyelet positioned vertically above the spool and then in the right rear eyelet of the thread guide.
- > Guide the thread once around the thread pre-tension (1) in a counterclockwise direction.
- > Wind the thread clockwise three or four times around the empty bobbin.
- > Pull the excess thread over the thread cutter at the lever (2) and cut.

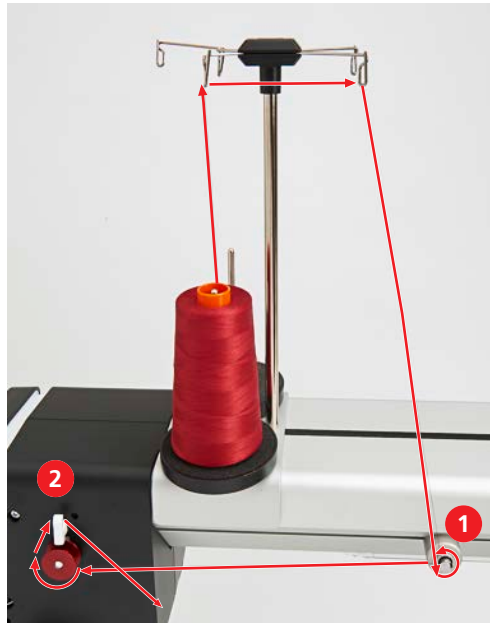

- > Press the lever down.

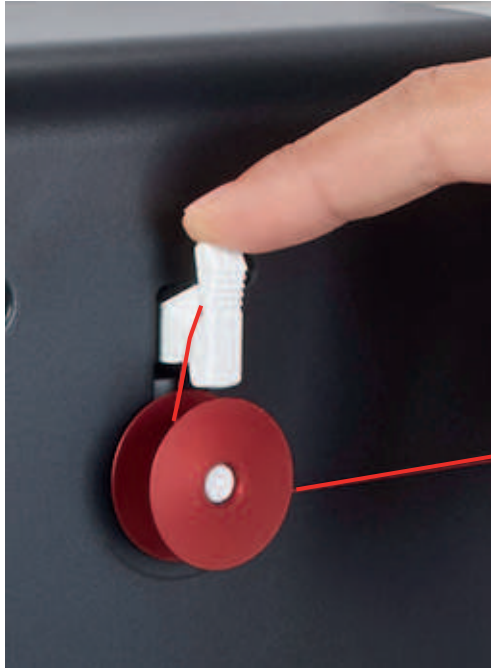

- The machine winds. Simultaneously, the display window «Set winding speed» will appear.

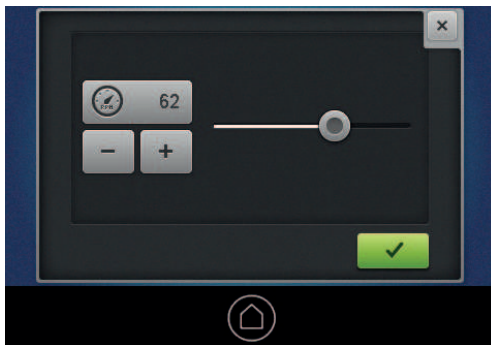

- > If required, adjust the winding speed.
 - The value set will be displayed.
 - As soon as the bobbin is full, the machine will stop.
- > Remove the bobbin and cut the thread with the thread cutter at the lever.



Threading the bobbin thread

- > Open the hook cover.
- > Hold the latch of the bobbin case.
- > Remove the bobbin case.
- > Remove the bobbin from the bobbin case.



- > Insert a new bobbin such that the label on the bobbin is visible.
- > Pull the thread into the bobbin case slot.

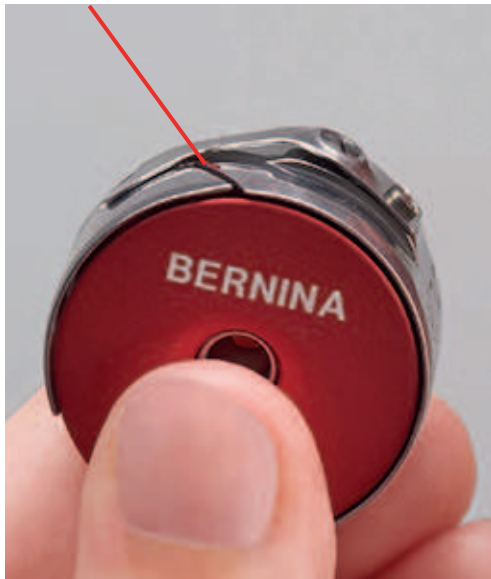

- > Pull the thread to the left under the spring and into the opening at the end of the spring.



- > Pull on the thread steadily and read the thread tension.



- > To reduce the thread tension, turn the larger screw on the bobbin counterclockwise.
- > To increase the thread tension, turn the larger screw on the bobbin clockwise.



- > Hold down overhanging thread with your finger and cut with the thread cutter.



Inserting the bobbin case

- > Hold the latch of the bobbin case.
- > Insert the bobbin case into the hook until it clicks into position.
- > Pull the thread over the thread cutter and cut.

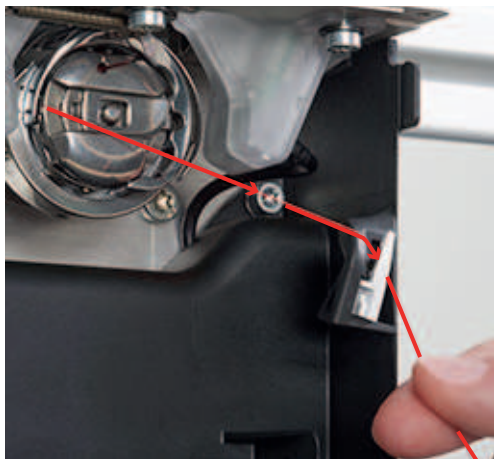

- > Close the hook cover.

Fill level of bobbin thread

To be able to display the fill level of the bobbin, the amount of thread that can be wound on the bobbin must be entered after each winding of the bobbin thread.

- > Tap «Bobbin filling».

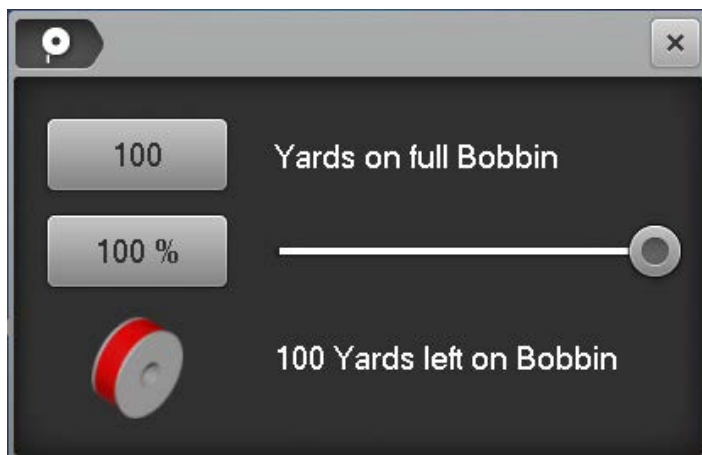

- > Tap the value next to «Yards on full Bobbin».
- > If you are using pre-wound bobbins, enter and confirm the indicated thread quantity in yards.
- > If you are using self-wound BERNINA bobbins, take the thread quantity of a full bobbin from the table in the appendix, and enter and confirm the value. (see page 79).
 - During quilting, the percentage display will run backwards.
 - A flashing symbol next to «Bobbin filling» indicates that the bobbin thread quantity has decreased to under 25%.



2.8 Upper thread

Threading preparation

- > Raise the needle.
- > **IMPORTANT:** Raise the presser foot.
 - The thread tension is released. The thread can be inserted without resistance.

Threading the upper thread



Place cross-wound spools and cones on the vertical spool pin. For smaller spools or parallel-wound spools, use the horizontal spool pin (optional accessory).

Prerequisite:

- Needle is raised.
 - **IMPORTANT:** Presser foot is raised.
 - The machine is switched on.
- > Place the spool on the left spool pin.
 - > Insert the thread first in the eyelet (1) positioned vertically above the spool and then in the front left eyelet (2) of the thread guide.
 - > First, guide the thread on the left-hand side of the machine through an upper thread guide (3).



- > Hold the thread above the lower thread guide with your left hand, pull it with your right hand in the direction of the arrow through the thread guide (4) and guide it through the slot (5) above the service door to the right-hand side of the machine.

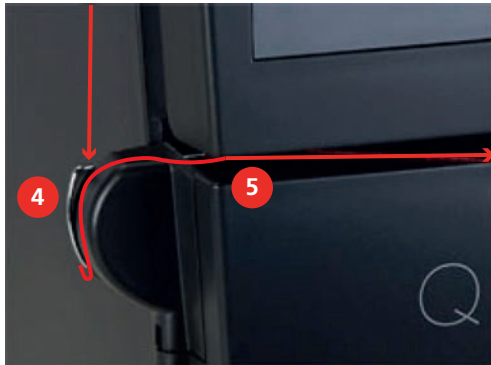

- > **IMPORTANT:** Check whether the presser foot has been raised and consequently whether the thread tension discs have been opened.
- > Pull the thread in a wide arc around the thread guide (6) in the direction of the arrow.



- This positions the thread between the thread tension discs. The left hand can let go of the thread.
- > Guide the thread on the right-hand side of the machine in the direction of the arrow around the thread regulator (7).



Setting up the machine

- > Pull the thread from left to right in front of the hook (12) and the needle and through the thread guide until it catches on the wire hook.

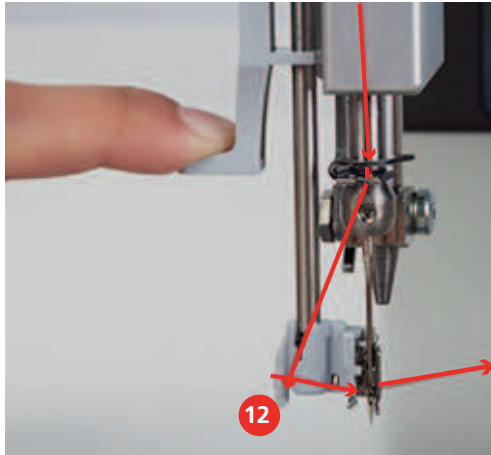

- > Slowly release the lever and the thread simultaneously.
 - The thread is pushed through the needle eye.
- > Pull the loop of thread to the rear until the end of the thread is pulled through the needle.

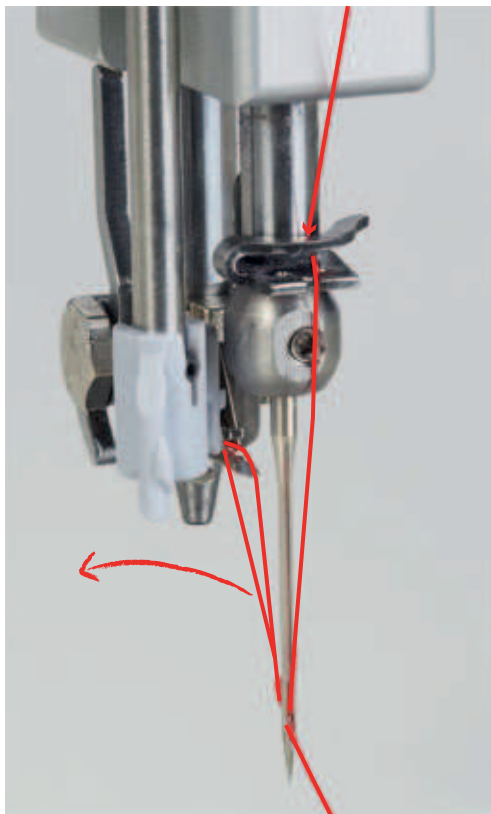

- > Pull the thread over the thread cutter (13) from the back to the front, then cut.

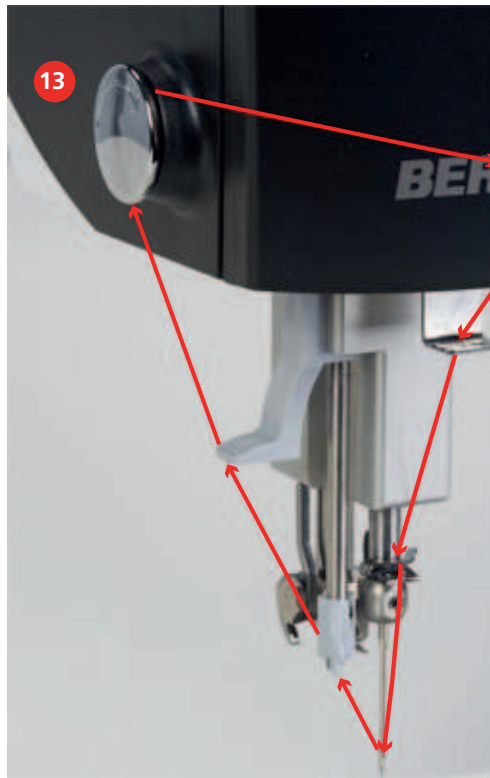

Check whether the thread is correctly positioned in the thread tension unit.

- > Lower the presser foot.
- > Pull the end of the thread.
 - If the thread can be pulled only with some resistance, it is correctly positioned in the thread tension unit.
 - If the thread can be pulled easily, it is not threaded correctly, and must be rethreaded.



If you are using iron-on batting or spray baste your quilt, first guide the thread on the left-hand side of the machine in sequence through the left eyelet, through the thread lubrication unit filled with silicone and through the right eyelet.



Threading the twin needle

When working with a twin needle, a twin needle stitch plate must be used. We also recommend using ruler foot #96.

Threading a twin needle differs from threading a single needle only in small – but important – details. The following instructions are illustrated only where they differ from normal threading.



Required parts and tools:

- Manual threader

Threading the left thread

Prerequisite:

- The twin needle is inserted.
 - Needle is raised.
 - Presser foot is raised. **IMPORTANT:** The thread can be inserted between the thread tension discs.
- > Place the spool on the left spool pin.
- > Insert the thread first in the eyelet positioned vertically above the spool and then in the front left eyelet of the thread guide.
- > First, guide the thread on the left-hand side of the machine through the upper left thread guide, then pull in the direction of the arrow through the lower thread guide.
- > Hold the thread above the lower thread guide with your left hand, and guide it with your right hand through the slot above the service door to the right-hand side of the machine.
- > **IMPORTANT:** Check whether the presser foot has been raised and consequently whether the thread tension discs have been opened.
- > Pull the thread in a wide arc around the thread guide (6) in the direction of the arrow.



- > Open the service door and check whether the thread is positioned between the two **rear** thread tension discs. If not, repeat the previous step.
- > Close the service door.
- > Guide the thread on the right-hand side of the machine in the direction of the arrow around the thread regulator.
- > Guide the thread up and thread into the take-up lever from the back to the front.
- > Guide the thread down and into the left opening of the thread guide underneath the service door.
- > Guide the thread from the right into the thread guide on the needle bar.
- > Place the thread into the slot of the manual threader.
- > Thread it into the left needle using the needle threader.

Threading the right thread

Prerequisite:

- The twin needle is inserted.
 - Needle is raised.
 - **IMPORTANT:** Presser foot is raised.
- > Place the spool on the right spool pin.



- > Insert the thread first in the eyelet positioned vertically above the spool and then in the front left eyelet of the thread guide.



- > First, guide the thread on the left-hand side of the machine through the upper right thread guide, then pull in the direction of the arrow through the lower thread guide.



- > Hold the thread above the lower thread guide with your left hand, and guide it with your right hand through the slot above the service door to the right-hand side of the machine.
- > **IMPORTANT:** Check whether the presser foot has been raised and consequently whether the thread tension discs have been opened.



- > Place the thread into the slot of the manual threader.

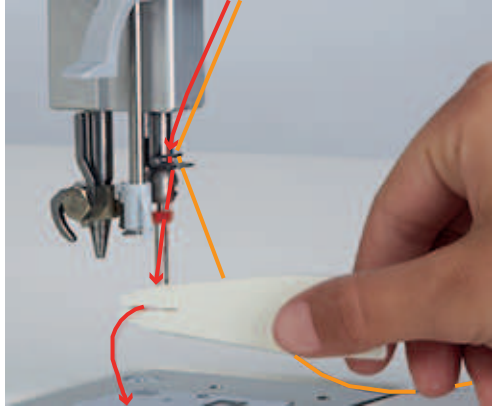

- > Thread it into the right needle using the needle threader.

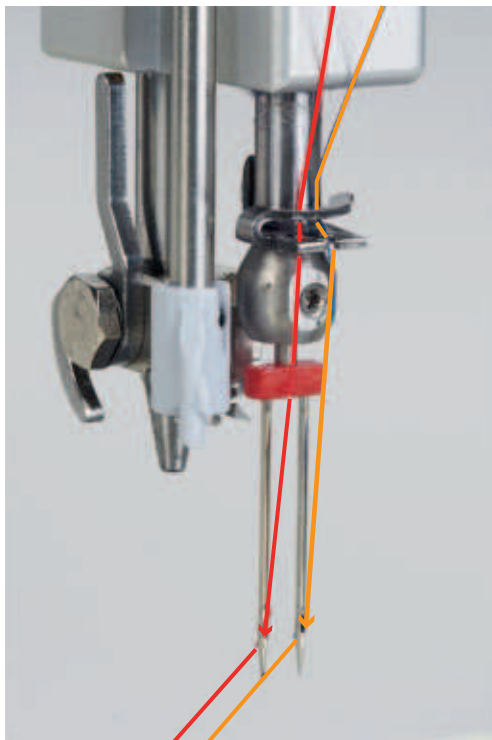

3 Settings

3.1 Overview Setup-Program



> Tap «Home».

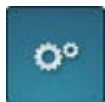

> Tap «Setup Program».

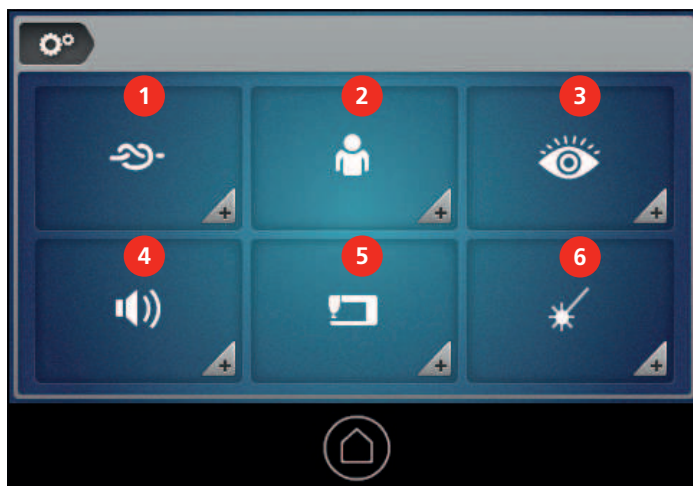

1 «Securing stitches»

2 «Personal settings»

3 «Monitoring functions»

4 «Setting Sound»

5 «Machine settings»

6 «Needle laser pointer»

3.2 Selecting the language



> Tap «Home».

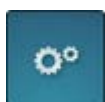

> Tap «Setup Program».



> Tap «Machine settings».

- > Tap «Welcome text».
- The current welcome message will be displayed.



- > To completely delete the welcome message, tap the text field.
- > Enter the text of your choice and confirm your entry.

Adjusting the screen brightness



- > Tap «Home».

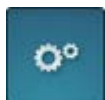

- > Tap «Setup Program».



- > Tap «Machine settings».



- > Tap «Screen settings».



- > Adjust the screen brightness in the top section of the screen (1).

3.4 Adjusting the sewing light



- > Tap «Home».

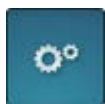

- > Tap «Setup Program».

3.6 Adjusting the needle laser pointer

Please note: The needle laser pointer is available as optional accessory. The settings for the needle laser pointer only apply if the needle laser pointer is installed. Refer to the needle laser pointer manual for more information.



> Tap «Home».

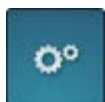

> Tap «Setup Program».



> Tap «Needle laser pointer settings».



> Switch the needle laser pointer on or off (1).

> Adjust the brightness of the needle laser pointer (2).

3.7 Setting up monitoring functions

If the monitoring functions are switched on, the machine stops as soon as the upper thread breaks or the bobbin is empty.



> Tap «Home».

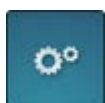

> Tap «Setup Program».



> Tap «Monitoring functions».



> Switch the upper thread monitor (1) on or off.

- > Switch the bobbin thread monitor (2) on or off.

3.8 Setting the securing stitches



- > Tap «Home».



- > Tap «Setup Program».



- > Tap «Securing stitches».

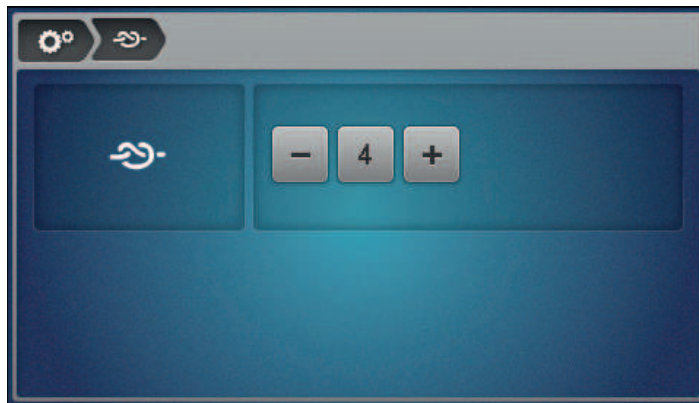

- > Set the desired number of securing stitches.

3.9 Adjusting the upper thread tension



4.5

- > Tap «Upper thread tension» on the sewing screen.
- > Adjust the upper thread tension.



3.10 Managing user profiles

Personal settings can be saved in up to five user profiles.

Creating a user profile



- > Tap «User profile» on the sewing screen.

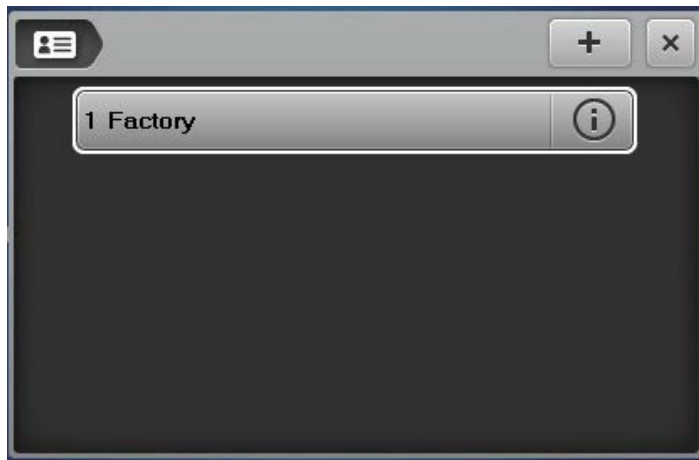

- > To create a new user profile, tap «Plus».



- > Adjust the upper thread tension.
- > Set the number of stitches per inch.
 - Setting will be used in BSR1 and BSR2 modes.
- > Adjust the idle speed.
 - Setting will be used in BSR1 mode.
- > Adjust the speed for manual mode.
- > Confirm entries.
- > Enter and confirm profile name.
 - The data will be saved. The new profile will be displayed in the profile overview.
- > Close the window.

Saving settings as a user profile



- > Tap «User profile».



- > Tap «Plus».
 - The altered values will be displayed in a new profile.
- > Confirm entries.

- > Enter and confirm profile name.
 - The data will be saved. The new profile will be displayed in the profile overview.
- > Close the window.

Deleting a user profile



- > Tap «User profile».



- > Tap «Info» next to the profile to be deleted.
 - The profile will be displayed.



- > Tap «Deleting a user profile».
 - The selected profile will be deleted and will no longer appear in the profile overview.

3.11 Selecting a user profile



- > Tap «User profile».
- > Tap the required user profile.
 - The number of the selected profile will be displayed. The profile settings will be adopted as new basic values.

3.12 Quilting modes

Your quilting machine has three BSR quilting modes and a manual mode available. BSR stands for BERNINA Stitch Regulator. The BSR ensures uniform stitch lengths, no matter how quickly you move the fabric or the machine. To achieve uniform stitch lengths, two optical sensors in the stitch plate measure the movement of the fabric in relation to the stitch plate. Based on this sensor data, the BSR regulates the speed at which the needle moves.

BSR1

BSR1 is the standard mode. This mode is particularly suitable for quilt patterns with many changes of direction. It allows uniform quilting even when the fabric or the machine stops briefly at the turning point of a pattern, because the machine does not immediately switch off if the sensors do not register any movement between the fabric and stitch plate.

With BSR1 mode, you can adjust the required number of stitches per inch and the idle speed at which the needle continues sewing when the fabric or the machine comes to a halt.

BSR2

In BSR2 mode, the needle remains stationary if the sensors do not register any movement between the fabric and stitch plate, and immediately starts sewing again once the sensors register movement.

NOTICE! The machine starts sewing immediately even if the machine or the fabric has been moved unintentionally, by touching the frame or the fabric.

With BSR2 mode, you can set only the required number of stitches per inch.

BSR3

BSR3 mode is a basting mode. In basting mode, you can choose between three stitch lengths:

- SPI 1: One stitch per inch
- SPI 2: Two stitches per inch
- SPI 4: Four stitches per inch

Manual mode (MAN)

In manual mode, the BSR is switched off. The stitch lengths depend on how fast the fabric or the machine is being moved.

With manual mode, you can set only the idle speed.

3.13 Displaying the total number of stitches



> Tap «Home».



> Tap «Setup Program».



> Tap «Machine settings».



> Tap «Information».



> Tap «Machine data».

Machine Data	
Software Version	V37.47.42
Data Version	V37.47.42
Bootloader Version	Undefined Bootloader Version
RAM	49000 KB
Flash	-1612640 KB / -134148 KB
BSR Version	0033 /
Total Number of Stitches	0 1
Total Number of Stitches since Maintenance	0

- The total number of stitches and the number of stitches since the last maintenance (1) will be displayed.

3.14 Registering details of the dealer



> Tap «Home».

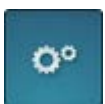

> Tap «Setup Program».



> Tap «Machine settings».



> Tap «Information».



> Tap «Dealer data».



> To enter the name of your specialist BERNINA dealer, tap «Name».
> Enter and confirm the name of the dealer.



> To enter the address of your specialist BERNINA dealer, tap «Address».
> Enter and confirm the address of the dealer.



> To enter the telephone number for your specialist BERNINA dealer, tap «Phone number».
> Enter and confirm the telephone number of the dealer.



> To enter the website or the e-mail address of your specialist BERNINA dealer, tap «E-mail address».
> Enter and confirm the IP address of the dealer.

3.15 Saving Service data

The service data regarding the current status of the machine can be saved on a USB stick and consequently provided to the specialist BERNINA dealer.

> Insert the BERNINA USB stick (optional accessory) with enough free storage capacity into the machine's USB slot.

> Tap «Home».



> Tap «Setup Program».



> Tap «Machine settings».



> Tap «Information».



> Tap «Service data».



> To save the service data, tap «Export the service data».
– While the data is being saved, the icon will appear dark with a white border.
> Once the icon appears gray again, remove the USB stick.

3.16 Restoring factory settings

> Tap «Home».



4 Tips for problem-free quilting

The quality of the needle, thread and fabric plays a decisive role in perfect quilting results.

4.1 Fabric

High-quality fabrics, precise cutting and sewing and evenly pressed seams provide the foundation for excellent quilting results.

4.2 Thread

Threads are exposed to extremely high speeds and tensions during longarm quilting. Only high-quality quilting threads from well-known manufacturers can withstand these stresses, produce clean seams and ensure excellent quilting results. High quilting quality is not achievable with embroidery threads or other threads. These threads can break often.





Several thread types are suitable for quilting with your BERNINA Q 20:

- High-quality cotton threads that can withstand the high speeds of longarm quilting are made from Egyptian cotton. Cotton threads are offered in various strengths, ranging from 28 wt to 60 wt ⁽¹⁾.
- Polyester threads for longarm quilting are less likely to break than cotton threads and produce less lint. Polyester threads are mainly offered in strengths ranging from 30 wt to 100 wt ⁽¹⁾. The finer polyester threads (50 and 60 wt) are very well suited to use as bobbin thread and are also available pre-wound.
- Silk threads are primarily available sized 100 wt. Silk threads are well suited for microwork and fine fillers.
- Metallic threads are used to achieve special effects. For metallic threads to withstand the higher speeds of longarm quilting, thicker needles must be used and the upper thread tension must be reduced.
- Thicker threads (12 and 28 wt⁽¹⁾) are ideally suited to achieve special effects. If thicker threads are used, the quilting speed must be reduced.

⁽¹⁾ Higher values stand for fine threads and low values for thicker threads.

4.3 Needle

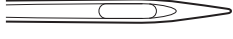
For longarm quilting, the recommended needles are listed in the following table.

Illustration	Needle name	Needle description
	Universal 130/705 H/60-100	Average point, slightly rounded
	Quilting 130/705 H-Q/75-90	Fine point
	SUK needle 130/705 H-SUK/70-90	Large eye, slight ball point
	Cordonnet/topstitch 130/705 H-N/80-100	Small ball point, long eye
	Double needle 130/705 H-ZWI/70-100	Needle distance: 1.0/1.6/2.0/2.5/3.0/4.0

What do the numbers/initials in the needle name mean?



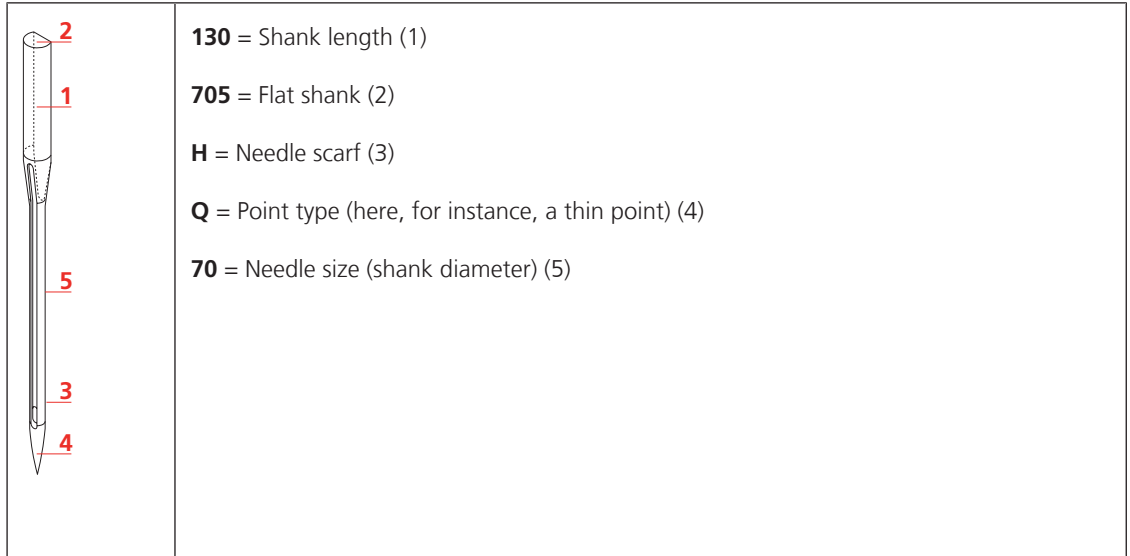

Needle selection

Needle and thread must be ideally matched. Select the appropriate needle thickness for the thread size.

You can find recommended needle and thread combinations in the following table.

Thread weight	wt	Needle thickness
Very thick	12 – 28	100 – 120
Thick	30 – 40	100 – 110
Thin	50 – 60	80 – 90
Very thin	From 60	70 – 80



If the thread breaks frequently, use a thicker needle.

Further tips

- Make sure that you thread the needle correctly.
- Determine the appropriate thread tension based on a sewing sample.
- Use spool discs.
- Use spool nets.

4.4 Using a spool disc

Spool discs hold the thread spool in place for proper release of thread from the spool. Spool discs also fix small spools onto the vertical spool holder.

On the vertical spool holder

- > Place the spool on the vertical spool holder.
- > Place the spool disc on the vertical spool holder such that there is no clearance between the spool disc and the spool.



On the horizontal spool holder

The horizontal spool holder is available as optional accessory.

- > Place a spool disc on the horizontal spool holder.
- > Place the spool on the spool holder.
- > Place the second spool disc on the horizontal spool holder such that there is a little clearance between the spool discs and the spool. The spool must be able to rotate slightly while the thread is unwinding, so that the thread tension is not affected.

4.5 Using a spool net

Spool nets ensure that the upper thread is drawn off evenly from the spool. Spool nets prevent the possibility of the thread catching on the edge of the spool and breaking.



5 Preparing to work on a quilt

5.1 Loading the frame

For Frame model only.

Requirements for good quilting results

The preparation of the fabric is extremely important for a beautiful quilting result.

- All corners must be exactly rectangular.
- All edges must be cut very straight and clean.
- The top and bottom edges must be exactly parallel.
- The fabric must be ironed smooth, seams must lie nice and flat.
- The quilt backing should be at least 10 cm (4 in) larger than the quilt top all around.
- The batting should be at least 5 cm (2 in) larger than the quilt top all around.

Loading the quilt backing

If the backing fabric is composed of several panels, spread the fabric so that the seams are parallel to the rolls.

Attach the lower edge of the quilt backing to the back leader so that the wrong side is facing up and the right (beautiful) side is facing down.

- > At the lower edge, find the center of the quilt backing.
- > Pin the centre of the fabric to the centre line of the leader.
- > Pin the fabric from the centre outwards to the right and left and roll up.

Attach the upper edge of the quilt backing to the take up leader so that the wrong side is facing up and the right (beautiful) side is facing down.

- > At the upper edge, find the center of the quilt backing.
- > Pull the take-up leader forward below the dead bar.
- > Pin the centre of the fabric to the centre line of the leader.
- > Pin the fabric from the centre outwards to the right and left and roll up.

Quilt Top

Attach the lower edge of the quilt top to the top leader so that the right side is facing up.

- > At the lower edge, find the center of the quilt top.
- > Pin the centre of the fabric to the centre line of the leader.
- > Pin the fabric from the centre outwards to the right and left and roll up.

Loading batting and quilt top

- > Place the batting on the quilt backing so that the top edge is parallel to the top edge of the backing.
- > Let the remaining length of the batting hang down between backing rail and top rail.
- > Pull the quilt top from the top rail and place it onto the batting so that the upper edge of the Quilt top is parallel to the upper edge of the batting.



5.2 Basting quilt layers

For Sit down model only.

Fix the quilt layers before quilting with safety pins, spray glue or with basting stitches.

For Frame model only.

To prevent the quilt from shifting during quilting, it must be basted on the top edge and on both sides. Baste the quilt as close to the edge as possible so that the basting stitches are not visible after the quilt is bordered.

Basting the upper edge

- > If mechanical channel locks are fitted, block the vertical channel locks so that the machine can only be moved to the right and left.
- > Select Mode BSR3.
- > Select SPI 2 or SPI 4
- > Start at the upper left corner of the quilt.
- > Pull up the bobbin thread and secure.
- > Baste the upper edge slowly and carefully.
- > At the end, secure, pull up the bobbin thread, and cut all threads.

Basting the sides

- > If mechanical channel locks are fitted, block the horizontal channel locks so that the machine can only be moved to the up and down.
- > Select Mode BSR3.
- > Select SPI 2 or SPI 4
- > Start at the upper left and right corners.
- > Pull up the bobbin thread and secure.
- > Baste both sides slowly and carefully one after the other until the machine hits the rail.
- > At the end, secure, pull up the bobbin thread, and cut all threads.
- > Each time after each of the quilt, baste both sides until the machine hits the rail.

5.3 Sewing sample

Create sewing samples, e.g. to determine the optimum thread tension or to try out various stitch lengths. You might also want to practice a pattern before you sew it onto the quilting project. Sewing samples are excellent for this.

Always use the same materials for the sewing sample that you will be using for your quilting project. Only in this way can you gauge the settings correctly.

If you try out various settings, you can write the set values directly onto the sewing samples. You can keep sewing samples labeled like this as a reference for future projects.



6 Practical quilting

6.1 Standard procedure for quilting

To start quilting

- > Place the starting point under the needle.
- > To pull the bobbin thread up, sew one stitch. (see page 25)
Move the machine or the fabric a little to the side and pull on the upper thread until the bobbin thread comes up.
- > Place the starting point under the needle again.
- > Sew the securing stitches. (see page 25)
- > Start quilting.

To finish quilting

- > Finish quilting at the finishing point.
- > Sew the securing stitches. (see page 25)
- > Move the machine or the fabric approx. 10 cm away from the finishing point and hold the upper thread.
- > Place the finishing point under the needle again.
- > To pull the bobbin thread up, sew a complete stitch while holding the upper thread. (see page 25)
Pull on the upper thread until the bobbin thread comes up.
- > Cut the threads at the starting point and finishing point.

6.2 Starting and stopping the machine

Sit down model

- > Press the foot control at the front all the way down and keep it pressed.
 - In manual mode, the machine starts sewing immediately.
 - In BSR1, BSR2 and BSR3 quilting modes, the machine starts sewing as soon as the fabric is moved.
- > Release the foot control.
 - The machine will stop.

As an alternative, you can use the «KickStart»function. (see page 25)

Frame model

Prerequisite:

- One handle button has been programmed with «Starting and stopping the machine». (see page 26)
- > To start the machine, press the corresponding handle button.
- > Move the machine.
 - Machine starts sewing.
- > To stop the machine, press the corresponding handle button again.
 - The machine will stop.



6.3 Controlling the speed

Frame model

In the three BSR modes, you can specify the required stitch length in the settings. Using the BSR sensors in the stitch plate, the machine measures the speed at which you are moving the the machine, and adjusts the speed of the needle such that stitches of the required length are sewn.

In manual mode, you can specify in the settings the maximum speed at which the needle will move. With the movement of the machine you control the stitch length. Additionally you can program 2 buttons on the handles to increase or decrease the speed of the needle. (see page 26)

Sit down model

In the three BSR modes, you can specify the required stitch length in the settings. Using the BSR sensors in the stitch plate, the machine measures the speed at which you are moving the fabric, and adjusts the speed of the needle such that stitches of the required length are sewn.

In manual mode, you can specify in the settings the maximum speed at which the needle will move if you press the foot control all the way down.



7 Care and maintenance

7.1 Firmware

Verifying the software version



> Tap «Home».



> Tap «Setup Program».



> Tap «Machine settings».



> Tap «Information».



> Tap «Machine data».
– The current version of the machine software will be displayed.

Machine Data	
Software Version	V37.47.42
Data Version	V37.47.42
Bootloader Version	Undefined Bootloader Version
RAM	49000 KB
Flash	-1612640 KB / -134148 KB
BSR Version	0033 /
Total Number of Stitches	0
Total Number of Stitches since Maintenance	0

Updating firmware

Downloading an update

You can download the latest firmware version from www.bernina.com and set it up according to the firmware update installation instructions, which you can likewise find on the website.





Perform firmware update

Prerequisite:

- The latest firmware version is loaded onto a USB stick in accordance with the firmware update installation instructions (see www.bernina.com).

> Insert the USB stick with the new firmware version into the machine's USB port.
> Tap «Home».



-  > Tap «Setup Program».
-  > Tap «Machine settings».
-  > Tap «Maintenance/updates».
-  > Tap «Updating firmware».
-  > To back up personal data and settings, tap «Save Data».
 - Wait until the data has been backed up onto the USB stick.

NOTICE**Incomplete update due to removing the BERNINA USB stick too early**

If the software has not been updated or has not been fully updated, the machine cannot be used.

- > Remove the BERNINA USB stick only once the update has been successfully completed.

Update

- > To start the firmware update, tap «Starting firmware update».
 - Wait until the firmware update has finished.

Starting the Service Programm





The Service Program allows the service technician to fix errors and to readjust individual functions.

Along with the diagnostic instructions in the service manual, the service program is accessible and usable for diagnosis by the user and remote diagnosis. The BERNINA specialist dealer can check the functions and give support for troubleshooting.

NOTICE**Wrong settings in Service Program**

Impairment of the machine function.

- > Carry out settings in the service program only under the guidance of the specialist dealer or have them carried out by the specialist dealer.
- > Password protected settings can only be carried out by the specialist dealer.

-  > Touch the icon «Home».
-  > Touch the icon «Setup Program».
-  > Touch the icon «Machine settings».
-  > Touch the icon «Maintenance/Update».



- > Touch the icon «Service Program».
- > Settings in the service program can be carried out according to the service manual.



7.2 Machine

Cleaning the screen

- > Wipe the screen with a soft, slightly damp microfiber cloth.

Calibrating the screen

NOTICE

Damage to the screen caused by a sharp object

Touching the screen with a sharp object can scratch the surface and affect the touch sensitivity.

- > Tap the screen with a blunt object.



- > Tap «Home».

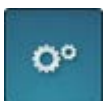

- > Tap «Setup Program».



- > Tap «Machine settings».



- > Tap «Calibrate screen».

- > To calibrate the front screen, tap «Calibrating the front screen» (1).

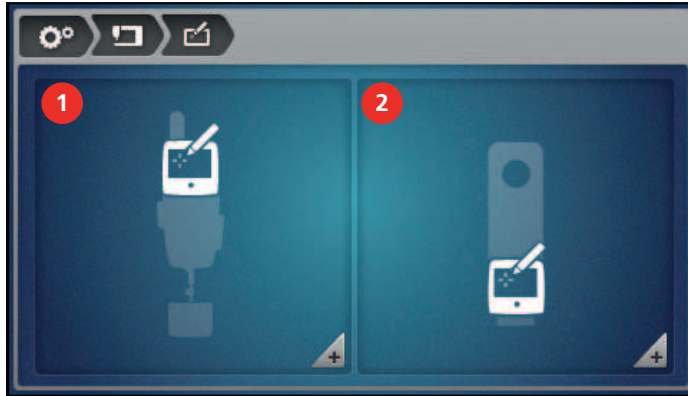

- A cross will be displayed on the screen.

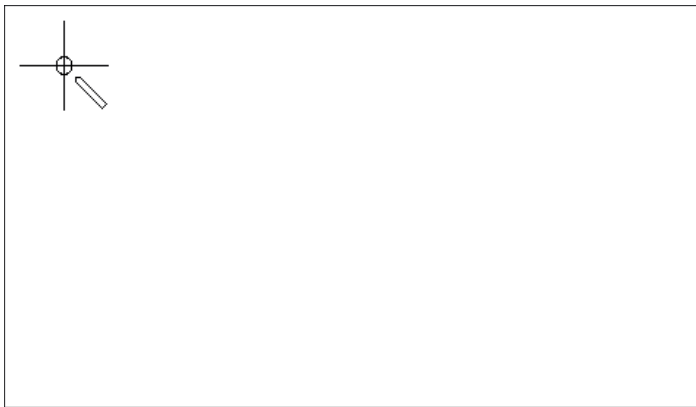

- > Tap the middle of the cross with a blunt object.
 - Further crosses will be shown on the screen one by one in different positions.
- > Tap the middle of each cross.
 - If no further crosses are shown, the relevant screen has been calibrated.

If a second screen is connected at the rear of the machine, it must be calibrated in the same way. To do that, tap «Calibrating the rear display» (2) on the «Calibrate screen» screen.

Cleaning the bobbin case



Electronically driven components

Risk of injury near the needle and the hook.

- > Switch off the machine and disconnect it from the power supply.

- > Open the hook cover.
- > Remove the bobbin case.
- > Remove the bobbin from the bobbin case.
- > Remove dust, fabric and thread remnants with the brush.
 - If fabric and thread remnants have become caught under the brake spring, the brake spring must be removed.
- > To remove the brake spring, push a flat object (e.g. screwdriver) under the brake spring until it jumps out.
- > After cleaning, fit the brake spring back into the bobbin case.

- > The brake spring must be inserted into the bobbin case as illustrated.
 - The inner loop of the brake spring (1) must be higher than the outside.
 - The opening (2) of the brake spring must face in the same direction as the opening of the bobbin case.

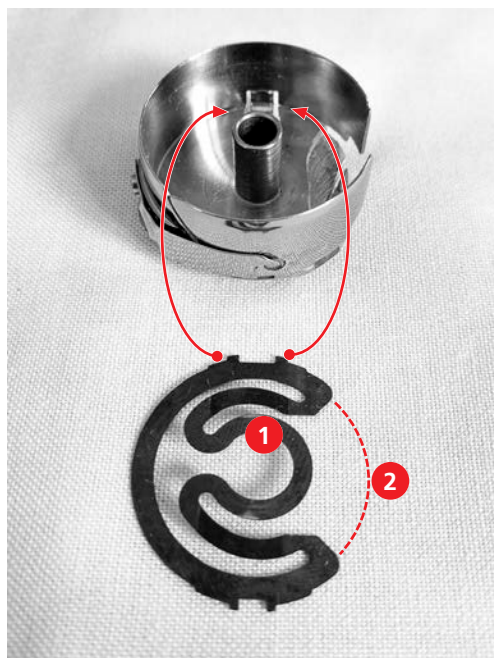

- > Press both upper tips into the upper openings on the bottom of the bobbin case until they snap into position.
- > Press both lower tips into the lower openings on the bottom of the bobbin case until they snap into position.
- > Check whether the brake spring has been inserted correctly.
 - The tips of the brake spring must be visible from outside.

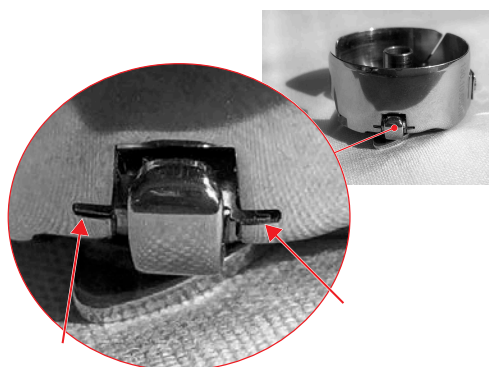

- > Place the bobbin into the bobbin case and thread the bobbin thread.
- > Insert the bobbin case.
- > Close the hook cover.

Cleaning the hook



Electronically driven components

Risk of injury near the needle and the hook.

- > Switch off the machine and disconnect it from the power supply.

- > Remove the needle and presser foot.
- > Press down the stitch plate at its right rear corner until it tips.
- > Remove the stitch plate.
- > Open the hook cover.
- > Remove the bobbin case.
- > Remove dust, fabric and thread lint with the brush.

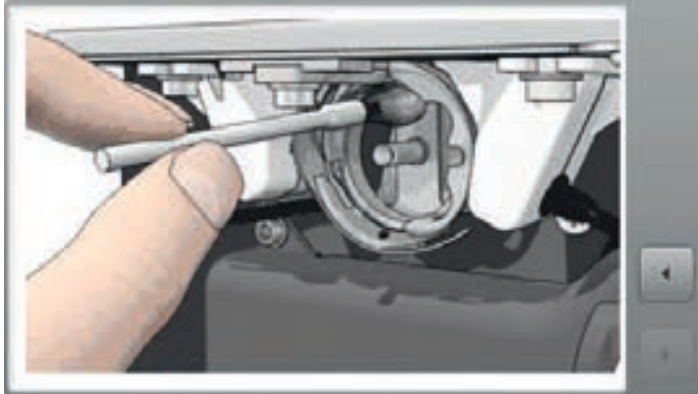

- > Insert the bobbin case.
- > Close the hook cover.

Lubricating the machine

The machine should be lubricated once a day or after a prolonged period of non-use.



Electronically driven components.

Risk of injury near the needle and the hook.

- > Switch off the machine and disconnect it from the power supply.

- > Remove the presser foot and the needle.
- > Remove the stitch plate.
- > Turn the handwheel until the hook race is visible and accessible.
- > Add one drop of BERNINA oil to the hook race.



- > Turn the handwheel two to three times, so that the oil can spread.
- > Fit the stitch plate.

7.3 Quilting frame

Checking and cleaning the frame

Over time the frame may settle and the structure should be checked periodically for proper leveling.

- > Using a spirit level, make sure the frame is level front to back and left to right.
- > Move the machine to different positions on the frame and let go. The machine should stay in place. If the machine is moving, level the frame accordingly. (refer to the Frame installation manual)
- > Make sure that the counter nuts on all legs are firmly tightened.
- > The middle legs must touch the floor. Make sure they are slightly overextended to minimize vibration of the machine and frame.
- > Check that the load-bearing screws are properly tightened.
- > Check the tracks. Wipe off deposits and sticky residues that have accumulated with a cloth and soap solution, and rub dry.
- > Wipe all four black rails with a cloth and soap solution, and rub dry.

Checking and cleaning the carriage

- > Check all 16 wheels of the carriage:
 - Are there accumulated threads?
 - Do wheels move freely?
 - Are there sticky residues on the running track?
- > Wipe the running surface of all wheels with a cloth and soap solution, and rub dry.
- > Check black rails for deposits and sticky residue.
- > Wipe black rails with a cloth and soap solution, and rub dry.
- > Check that all wheels make contact with the black rails, and that the carriage can be moved over the entire length and width of the frame.

If necessary, adjust the position of the wheels. (refer to frame assembly manual)

7.4 Quilting table

Cleaning and maintenance

NOTICE

Incorrect cleaning

The surface of the quilting table gets roughened.

The fabric cannot be guided over the table easily.

- > Never use oils, waxes, bleaching agents or scouring agents for cleaning.
- > Wipe the quilting table only with a damp cloth or, at most, with a mild soap and water.

- > Wipe the table with a damp cloth then rub dry. If required, use a mild soap and water.

Moving or transporting the table

NOTICE! The following instructions apply only to quilting tables that can be moved or transported.

- > To find out whether your quilting table can be moved, consult the table's assembly instructions.
- > Before you move the table, remove the machine and the tabletop extension elements.

CAUTION

Heavy sit down table

Lifting the quilt table can cause back injuries.

Accidentally dropping the sit down table can cause injuries and damage to property.

- > Always set up the sit down table with the help of a second person.
- > Alternatively use a suitable furniture trolley.

- > To lift the table, hold the table only by the lower section (foot and/or base of the tabletop), not by the extension elements.

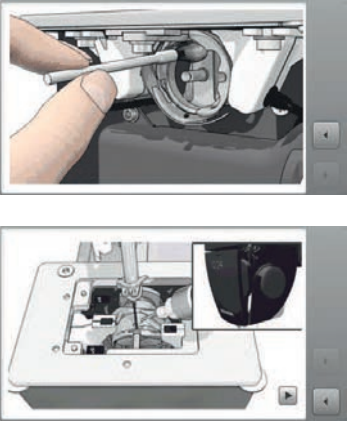

Error messages	Explanation	Remedy
	<p>The machine needs cleaning/lubricating.</p>	<ul style="list-style-type: none"> > Clean/lubricate the machine according to instructions.
<p>Insufficient free space on the BERNINA USB stick (optional accessory).</p>	<p>There is not enough free capacity on the BERNINA USB stick (optional accessory).</p>	<ul style="list-style-type: none"> > Make sure that the BERNINA USB stick (optional accessory) is used. > Delete data from the BERNINA USB stick (optional accessory).
<p>No personal data on the BERNINA USB stick (optional accessory).</p>	<p>No personal data for recovery available on the BERNINA USB stick (optional accessory).</p>	<ul style="list-style-type: none"> > Make sure that the data and settings have been saved on the BERNINA USB stick (optional accessory).
<p>BERNINA USB stick is not inserted.</p>	<p>No BERNINA USB stick (optional accessory) inserted.</p>	<ul style="list-style-type: none"> > Use a BERNINA USB stick (optional accessory) providing enough free capacity. > Make sure that, throughout the entire automatic update, the same BERNINA USB stick (optional accessory) always remains inserted.
<p>Firmware update failed.</p>	<p>The latest firmware version cannot be found on the USB stick.</p>	<ul style="list-style-type: none"> > Make sure that the compressed zip file has been unzipped for the firmware update. > Make sure that the data for the firmware update is stored in the root directory and not in a folder on the USB stick. > Updating Firmware.

Error messages	Explanation	Remedy
It is time for the regular maintenance. Please contact your dealer to make an appointment.	<p>The machine needs maintenance. The message appears after the programmed service interval has expired.</p> <p>Important information: Having your machine cleaned and serviced properly at the appropriate times ensures its proper functioning and a long service life. Ignoring the terms can affect the operating life and restrict the guarantee. The cost allocation for maintenance work is regulated nationally. Consult your dealer or your servicing shop for more details.</p>	<ul style="list-style-type: none"> > Contact a specialist BERNINA dealer. > Delete the message temporarily by touching the «ESC» icon. <p>When you clear the message three times, it will not be displayed until the next service interval is reached.</p>

8.2 Troubleshooting

The following information will help you to remedy possible machine faults yourself.

Check whether:

- The upper and bobbin thread are correctly threaded.
- The needle is inserted correctly.
- the needle size is correct; see needle/thread table page. (see page 57)
- The needle point and shaft are undamaged.
- The machine has been cleaned and thread residue has been removed.
- The hook race has been cleaned.
- Thread remnants have been trapped between the thread tension discs and under the bobbin case spring.

Fault	Cause	Remedy
Uneven stitch formation	Upper thread too tight or too loose.	<ul style="list-style-type: none"> > Reduce/increase the upper thread tension. > Check the bobbin thread tension with the Bobbin thread tension gauge.
	Needle blunt or bent.	> Use a new BERNINA quality needle.
	Needle substandard.	> Use a new BERNINA quality needle.
	Thread substandard.	> Use quality thread.
	Needle/thread ratio incorrect.	> Match the needle with the thread size.
	Incorrectly threaded.	> Check the upper and bobbin thread.



Fault	Cause	Remedy
Skipped stitches	Incorrect needle system.	> Use the 130/705H needle system.
	The needle is bent or blunt.	> Use a new BERNINA quality needle.
	Needle substandard.	> Use a new BERNINA quality needle.
	The needle is incorrectly inserted.	> Push the needle all the way to the top when inserting.
	Incorrect needle point.	> Match the needle point to the texture of the material.
	Quilt sandwich pulled too tight.	> Do not pull the quilt sandwich too tight.
	Quilt sandwich with adhesive fleece.	> Use silicone lubrication.
Upper thread breaks	Needle/thread ratio incorrect.	> Match the needle with the thread size.
	Upper thread is too tight.	> Reduce the upper thread tension. > Check the bobbin thread tension with the Bobbin thread tension gauge.
	Not threaded properly.	> Check the upper thread.
	Substandard or old thread.	> Use quality thread.
	Stitch hole or hook tip damaged.	> Get in contact with the specialist BERNINA dealer.
Lower thread breaks	Bobbin thread tension too high.	> Increase the upper thread tension, or adjust the bobbin thread tension with the bobbin thread tension gauge.
	The stitch hole in the stitch plate is damaged.	> Get in contact with the specialist BERNINA dealer.
	Needle blunt or bent.	> Use a new needle.
	Bobbin thread caught.	> Check the bobbin thread.
Needle breaks	Needle not properly secured.	> Tighten the screw of the needle holder.
	Substandard thread with knots.	> Use quality thread.
Screen not responding	Incorrect calibrating data.	> Recalibrate the screen (see page 66)
	The eco mode is active.	> Deactivate eco mode.
Calibration screen cannot be opened	Screen not responding.	> Switch the machine off. > Keep your finger on the screen. > Switch on the machine while your finger is on the screen.

Fault	Cause	Remedy
Machine not running	Power switch to «0».	<ul style="list-style-type: none"> > Set the power switch to «I». > Get in contact with the specialist BERNINA dealer.
Neither the sewing light nor the light on the free arm lights up	Light switched off in the Setup Program.	> Switch on the sewing light. (see page 48)
	The sewing light is defect.	> Get in contact with the specialist BERNINA dealer.
Upper thread monitor doesn't react	Switched off in the Setup Program.	> Activate it in the Setup Program.
Bobbin thread monitor doesn't react	Switched off in the Setup Program.	> Activate it in the Setup Program.
Error during firmware update	USB stick is not recognized.	> Use a BERNINA USB stick.
	Firmware update is blocked (hourglass is inactive).	> Remove the USB stick. Switch the machine off and on again. Continue the update according to the notification.
	Update data is not recognized.	<ul style="list-style-type: none"> > Do not save update data in a folder. > Unzip update data.



9 Technical specifications

For Frame and Sit down model.

Designation	Value	Unit
Throat space	20 (508)	mm (inch)
Maximum sewing speed	2200	spm / rpm
Weight of the machine	29	kg
Input voltage	100-240	V
Protection class (electrical engineering)	II	

10 Storage and disposal

10.1 Storing the machine

- > Switch off the machine and disconnect it from the power supply.
- > Don't store the machine outdoors.
- > Protect the machine against climatic influences.

10.2 Dispose of the machine

BERNINA International AG is committed to environmental protection. We make every effort to increase the environmental friendliness of our products by continually improving their design and production technology.

If the machine is no longer required, dispose of it in an environmentally friendly way in accordance with the national guidelines or take it to the nearest BERNINA specialist shop. Do not dispose of the machine in the household waste.



11 Appendix

11.1 Amount of bobbin thread

Thread	Thread type	Thread weight	Thread quantity of a full BERNINA bobbin (yards)
Superior			
Bottom Line	100 % polyester	60	198
So Fine 50	100 % polyester	50	121
So Fine 40	100 % polyester	40	66
So Fine 30	100 % polyester	30	59
Fantastico	100 % polyester	40	107
Magnifico	100 % polyester	40	105
Twist	100 % polyester	40	109
King Tut	100 % cotton	40	94
Omni	100 % polyester	40	81
Lava	100 % polyester	35	87
Rainbows	100 % polyester	70	129
Kimono	Silk	100	236
MonoPoly	100 % polyester	Monofilament	360
Aurifil			
Aurifil variegated	100 % polyester	40	116
Aurifil	100 % cotton	40	92
Aurifil	100 % cotton	50	115
YLI			
YLI	100 % cotton	Tex 40	58
Signature			
Signature	100 % cotton	Tex 40	65

Thread	Thread type	Thread weight	Thread quantity of a full BERNINA bobbin (yards)
Mettler			
Silk Finish #50	100 % cotton	50	76
Silk Finish #60	100 % cotton	60	106
Seracor	100 % polyester	dtex 139/2	90
FilTec			
Glide	100 % polyester	40	128
Cairo quilt	100 % cotton	40	82
Cairo quilt	100 % cotton	Tex 35/50	83
Wonderfil Konfetti	100 % polyester	50	77
Wonderfil			
Decobob	100 % polyester	80	205
Invisafil	100 % polyester	100	260
Master Quilter	100 % polyester	40	80
Tutti	100 % cotton	50	65
Madeira			
Rheingold	100 % polyester	40	100
Aeroquilt	100 % polyester	40	105

Index

A

Accessories	15
Activate/deactivate function.....	17

B

Bobbin case	36, 67
Cleaning	67
Inserting.....	36
Bobbin thread.....	31
Level indicator	36
Pulling upward.....	25, 28
Setting thread tension.....	34
Threading	33
Winding.....	31
Bobbin thread monitor.....	50
Bobbin thread tension.....	34

C

Calculator	21
Cleaning the hook	68

D

Dealer data	54
Disposing of the machine.....	78

E

eco mode	20
Energy-saving mode.....	20
Environmental Protection.....	8
Error messages.....	72
Explanation of symbols	8

F

Factory setting	55
Fill level of bobbin thread.....	36
Firmware	
Activate/deactivate function	17
Navigation	17
Setting values.....	17
Updating.....	64
Fitting the spool pin.....	22

Foot control	24
Connecting	24
Programming the back kick.....	24

H

Handles	
Programming the handle buttons.....	26

L

Lubricating the machine.....	69
------------------------------	----

N

Navigation	17
Needle	
Changing.....	29
Lowering.....	29
Raising	29
Needle laser pointer	50
Needle selection.....	58
Needle stop up/down.....	29
Needle types	57

P

Presser foot	
Changing.....	28
Raising and lowering.....	28
Presser foot position	28

R

Replacing the stitch plate.....	30
---------------------------------	----

S

Saving the service data.....	55
Screen	47
Adjusting the brightness	48
Background color.....	47
Calibrating.....	66
Cleaning	66
Welcome message	47
Securing	25, 28
Selecting the language.....	46
Service Programm	65
Setting the securing stitches.....	51

Setting the sewing light	48
Setting values	17
Setup program.....	46
Software version	64
Sound settings.....	49
Spool disc	58
Spool net.....	59
Stitch counter	21
Storing the machine.....	78

T

Thread selection.....	57
Threading	33, 37, 41
Bobbin thread	33
Preparation	37
Twin needle	41
Upper thread	37
Total number of stitches	54
Troubleshooting.....	74
Twin needle	41
Threading	41

U

Upper thread	37
Preparation threading	37
Setting tension.....	51
Threading	37
Upper thread monitor.....	50
Upper thread tension.....	51
User profile	52, 53
Creating.....	52
Deleting	53
Selecting.....	53



THINK
BIG



In partnership with

Mettler

BERNINA International AG | CH-8266 Steckborn, Switzerland | www.bernina.com | © Copyright by BERNINA International AG

1048005_00A_04
2020-11

made to create **BERNINA**