



BERNINA 580



made to create **BERNINA**

LOOKING FOR A NEW SEWING PROJECT?

You can find what you want in "inspiration", our sewing magazine. Thanks to great sewing patterns and detailed sewing instructions, every project succeeds right away.

Inspiration magazine
is available in German, English,
French and Dutch



* Not available in all countries.

Dear Bernina Customer,

Congratulations! You've decided on BERNINA, a reliable choice that will delight you for years to come. For over 100 years, our family has placed the highest value on satisfied customers. For myself, it is a matter of personal pride to offer you Swiss precision at the height of perfection, future-oriented sewing technology, and a comprehensive customer service.



Presenting the B 580, BERNINA launches an ultramodern sewing-/embroidery computer. Apart from the highest demand on technology, we have also focused on the design; after all we sell our products to creative people like you, who expect a high standard of best quality and appreciate the design vocabulary.

Enjoy the creative sewing and embroidery with your BERNINA 580 and find out about our varied range of accessory. Let yourself be inspired by new sewing projects and visit us at www.bernina.com.

And don't forget to make use of service and maintenance offers from our highly trained BERNINA dealers.

I wish you lots of pleasure and many creative hours with your new BERNINA.

H.P. Ueltschi
Owner
BERNINA International AG
CH-8266 Steckborn
www.bernina.com

SAFETY INSTRUCTIONS

IMPORTANT INFORMATION

When using an electrical appliance, basic safety precautions should always be followed, including the following:

Read all the instructions before using this sewing-/embroidery computer.

When the sewing-/embroidery computer is not in use, it should be disconnected from the electricity supply by removing the plug from the outlet.

DANGER!

To reduce the risk of electrical shock:

1. The sewing-/embroidery computer should never be left unattended when plugged in.
2. Always unplug this sewing-/embroidery computer from the electrical outlet immediately after using and before cleaning.
3. LED Radiation – Do not view directly with optical instruments. Class 1M LED product.

WARNING!

To reduce the risk of burns, fire, electric shock or injury to persons:

1. Use this sewing-/embroidery computer only for purposes as described in this manual. Use only attachments, accessories and parts recommended by the manufacturer.
2. Do not allow this sewing-/embroidery computer to be used as a toy. Close attention is necessary when this sewing-/embroidery computer is used by or near children and infirm persons. The sewing-/embroidery computer is not intended for use by persons (including children) with reduced physical, sensory or mental capabilities or lack of experience and knowledge, unless they have been given supervision or instruction concerning use of the sewing-/embroidery computer by a person responsible for their safety. To ensure children do not play with the sewing-/

embroidery computer they must be supervised.

3. Never operate this sewing-/embroidery computer if:
 - it has a damaged cord or plug
 - it is not working properly
 - it has been dropped or damaged
 - it has fallen into waterReturn the sewing-/embroidery computer to your local authorized BERNINA dealer for examination or repair.
4. Never operate the sewing-/embroidery computer with any air openings blocked. Keep ventilation openings of the sewing-/embroidery computer free from the accumulation of lint, dust and loose cloth.
5. Keep fingers away from all moving parts. Special care is required around the sewing needle.
6. Never insert any objects into any openings on the sewing-/embroidery computer.
7. Do not use the sewing-/embroidery computer outdoors.
8. Do not operate the sewing-/embroidery computer where aerosol products (sprays) or oxygen are being used or where oxygen is being administered.
9. Do not pull or push the fabric while stitching. This may deflect the needle, causing it to break.
10. Do not use bent needles.
11. Always use the original BERNINA stitch plate. The wrong stitch plate can cause needle breakage.
12. To disconnect, turn power switch to «0» (off), then remove the plug from the outlet. Do not unplug by pulling the cord, instead grasp the plug to pull it from the outlet.
13. Turn power switch to «0» (off) when making any adjustments in the needle area, such as changing the needle or the presser foot, etc.
14. Always unplug the sewing-/embroidery computer from the electrical outlet when carrying out cleaning or maintenance work or any other user servicing adjustments mentioned in this manual.
15. This sewing-/embroidery computer is provided with double insulation (except USA and Canada). Use only identical replacement parts. See instructions for servicing of double-insulated products.

SERVICING DOUBLE-INSULATED PRODUCTS

In a double-insulated product two systems of insulation are provided instead of grounding. No grounding means is provided on a double-insulated product, nor should a means for grounding be added to the product. Servicing a double-insulated product requires extreme care and knowledge of the system and should be done only by qualified service personnel. Replacement parts for a double-insulated product must be identical to the original parts in the product. A double-insulated product is marked with the words: «DOUBLE INSULATION» or «DOUBLE INSULATED».

The symbol  may also be marked on the product.

DISCLAIMER

No liability will be assumed for any possible damage which arises from misuse of this sewing-/embroidery computer.

This sewing-/embroidery computer is intended for household use only.

This sewing-/embroidery computer meets the European Standard 2004/108/EC concerning the electromagnetic tolerance.

SAVE THESE INSTRUCTIONS!



Please find the latest version of your instruction manual at www.bernina.com

Environmental Protection



BERNINA is committed to the protection of the environment. We strive to minimize the environmental impact of our products by continuously improving product design and our technology of manufacturing.

When your sewing computer won't be used anymore, dispose this product in an environmentally responsible way according to the national directive. Do not throw away this product with your household waste. In case of doubt, please contact your BERNINA dealer.



If the sewing computer is stored in a cold room, it should be brought to a warm room about one hour before use.

Sewing - Contents		5
Accessory		7
Preparation		10
■ Overview sewing computer	10	
■ Sewing preparation	12	
Functions		26
■ «Function»-buttons sewing computer	26	■ Creative consultant 52
■ Overview Display	28	■ Help program 53
■ Setup Program	40	■ Balance 54
■ Tutorial	50	■ eco 55
Sewing stitches		56
■ Practical stitches	56	■ BSR 94
■ Buttonholes	74	■ Alphabets 99
■ Decorative stitches	88	■ Personal program 102
■ Quilt stitches	92	■ Combi mode 106
Embroidery - Contents		111
Cleaning		158
Troubleshooting		159
Stitch patterns		164
Motifs		171
Index		182



DANGER!

Very important! Risk of injury!

ATTENTION!

Very important! Risk of damage!



Tips!

Glossary

Balance	Correcting abnormalities in stitch formation due to the fabric
BERNINA USB stick	Mobile storage medium
Fabric fold	Folded edge of material
BSR	BERNINA-Stitch-Regulator. Quilting with consistent stitch length within a certain speed
clr	Deleting settings or data
Hook	«Catches» the needle-thread loop, forming the stitch together with the lower thread
LMS	Length Measuring System for buttonhole
Memory	Long Term Memory
Satin stitching	Dense Zig-zag
Bartack	Buttonhole-bead cross-connections

All rights reserved

For technical and product improvement reasons, the sewing computer's features, parts and accessory are subject to unannounced changes and alterations at any time. The accessory included can differ from country to country.

Standard Accessory



- Carrier bag
- Accessories box
- Foot control
- Power cable
- Slide-on table
- Seam Guide
- Free Hand System (FHS)

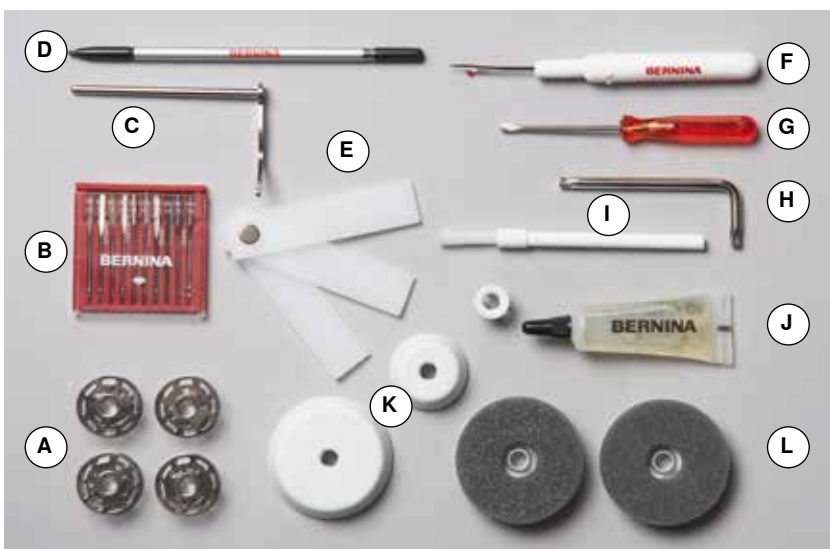

- A** 5 bobbins (one of them in the bobbin case)
- B** Selection of needles
- C** Seam guide, right
- D** Touch pen
- E** Height compensation tool
- F** Seam ripper
- G** Screwdriver, red
- H** Angular Torx button
- I** Lint brush
- J** Lubricator
- K** 3 spool discs
- L** 2 foam pads

Presser feet



- 1 No. 1C Reverse pattern foot
- 2 No. 2A Overlock foot
- 3 No. 3A Automatic buttonhole foot with slide
- 4 No. 4 Zipper foot
- 5 No. 5 Blindstitch foot
- 6 No. 8 Jeans foot
- 7 No. 20C Open embroidery foot

 Visit www.bernina.com for more accessory information.

Accessory box



Storing accessory

- on the back of the box, pull both extensions out until they click into place

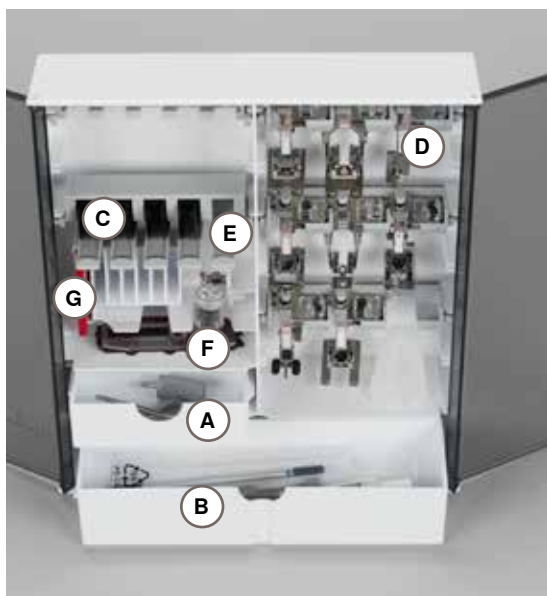

Storage example

The box is equipped as standard with one small **A** and one large **B** drawer as well as a compartment for bobbin holders **C** and presser feet **D**.

- to remove a bobbin, press the compartment holder **E** lightly
- buttonhole foot with slide no. 3A can be stored in the left compartment **F**
- store the needle range supplied in the special compartment **G**



All rights reserved

For technical and product improvement reasons, the sewing computer's features, parts and accessory are subject to unannounced changes and alterations at any time. The accessory included can differ from country to country.

10 Preparation - Overview sewing computer

Front view



Detail view

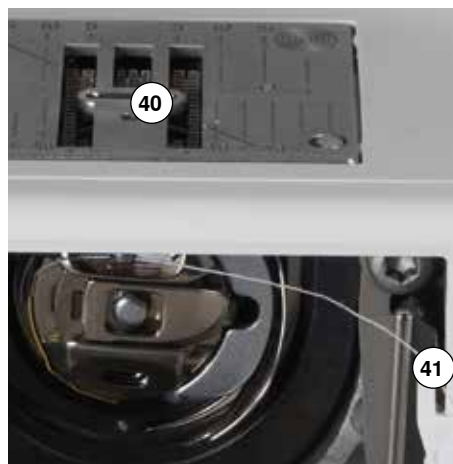
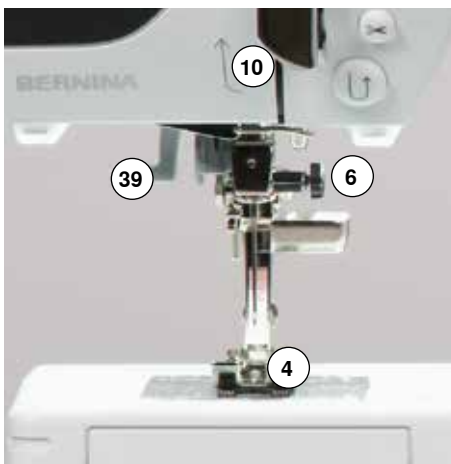



- | | |
|---|--|
| 1 Bobbin cover | 30 Handwheel |
| 2 Stitch plate | 31 Power switch On «I»/
Off «0» |
| 3 Attachment base for
special accessories | 32 Power plug socket |
| 4 Presser foot | 33 USB-connection |
| 5 LED-sewing light | 34 PC-connection for
embroidery software |
| 6 Needle clamp | 35 Connection for embroidery
module |
| 7 «Quick reverse»-button | 36 Foot control socket |
| 8 «Automatic thread cutter»-
button | 37 Feed dog drop |
| 9 «Start/Stop»-button | 38 Air vents |
| 10 Thread guide | 39 Needle threader |
| 11 Slide Speed Control | 40 Feed dog |
| 12 Thread take-up cover | 41 Cutter for lower thread |
| 13 «Needle stop»-button
down/up | 42 Presser foot pressure
adjustment wheel |
| 14 Programmable «Pattern
end-/securing»-button | 43 Headframe fixing screw |
| 15 Thread take-up lever | 44 Thread cutter on the head
frame (left) |
| 16 Pre-tension stud | 45 Slide-on table socket |
| 17 Display | 46 Darning hoop connection |
| 18 «Sewing support»-buttons | 47 Presser foot lifter |
| ■ «Home»-button | 48 BSR-connection |
| ■ «Setup»-button | |
| ■ «Tutorial»-button | |
| ■ «Creative Consultant»-
button | |
| ■ «Help»-button | |
| ■ «eco»-button | |
| ■ «clr»-button | |
| 19 «Needle position»-buttons | |
| 20 Stitch length knob | |
| 21 Stitch width knob | |
| 22 Carrying handle | |
| 23 Bobbin winder | |
| 24 Thread cutter on bobbin
winder | |
| 25 Free Hand System
connection | |
| 26 Rear thread guide | |
| 27 Horizontal spool pin | |
| 28 Vertical spool pin | |
| 29 Eyelet thread guide | |



USA/Canada only: The sewing computer has a polarized plug (one blade wider than the other). To reduce the risk of electrical shock, this plug is intended to fit in a polarized outlet only one way. If the plug does not fit fully in the outlet, reverse the plug. If it still does not fit, contact a qualified electrician to install the proper outlet. Do not modify the plug in any way!

Power Switch/Power Cable



1 Power Switch
The sewing computer is switched on («I») and off («0») with the power switch.

I the sewing computer is switched on
0 the sewing computer is switched off

- 2 Power plug socket
- 3 Foot control socket
- 4 Connection for embroidery module
- 5 PC-connection for embroidery software
- 6 USB-connection

Foot control



Before beginning to sew

- unwind the cable
- plug the cable in the outlet provided **A**
- unwind the cable to the desired length and slip into **B** or **C**

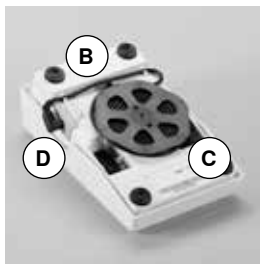
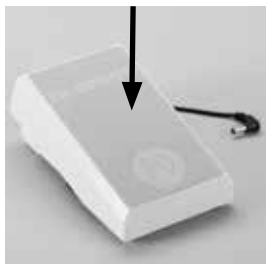

Sewing speed control

Control the sewing speed by pressing the foot control more or less.

Adjust needle down or up

- adjust the down/up position of the needle by sinking the heel back on the foot control

After sewing

- wind the cable around the reel
- plug cable into **D**



USA/Canada only: Use only foot controller type LV-1 with sewing computer B 580.

Slide-on table

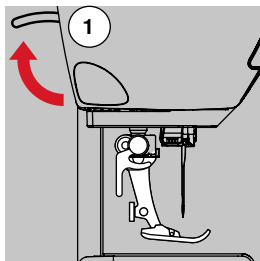

- turn the handwheel (see page 11)
- ▶ needle is raised
- raise presser foot lifter **1** up
- ▶ presser foot is lifted

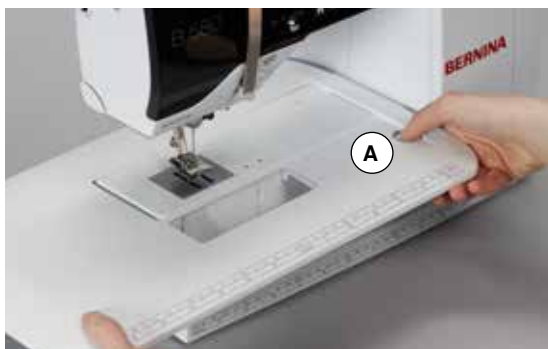

The slide-on table increases sewing surface.

Attaching the slide-on table

- raise the needle and presser foot
- slide over free-arm to the right until it engages

Removing the slide-on table

- raise the needle and presser foot
- press button **A** down
- pull slide-on table to the left



Seam Guide

- press the release button and insert into the groove (underside of table) from left or right
- Can be moved over the entire table length.

Free Hand System (FHS)



The FHS raises and lowers the presser foot.

Attaching the Free Hand System

- insert into the opening

Raising and lowering the presser foot

- with your knee push lever to the right
- You should be able to operate the FHS with your knee in your normal sitting position.
- ▶ the presser foot is raised; the feed dog is lowered simultaneously. The thread tension is released.

The feed dog is raised as soon as the first stitch is sewn.



Your dealer can adjust the FHS if necessary.

Vertical spool pin

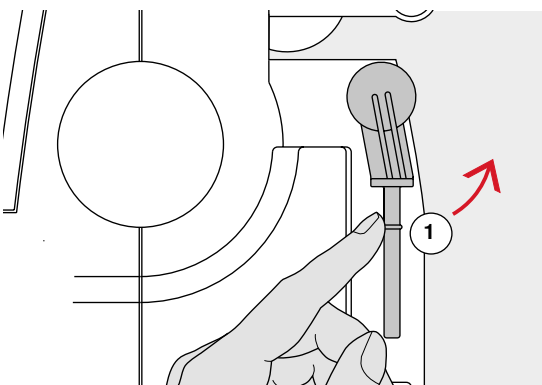

The vertical spool pin is on the side behind the handwheel.

It is an essential aid for sewing with more than one thread, e.g. double needle work and can also be used for winding the bobbin while sewing.

- turn the spool pin **1** as far it will go

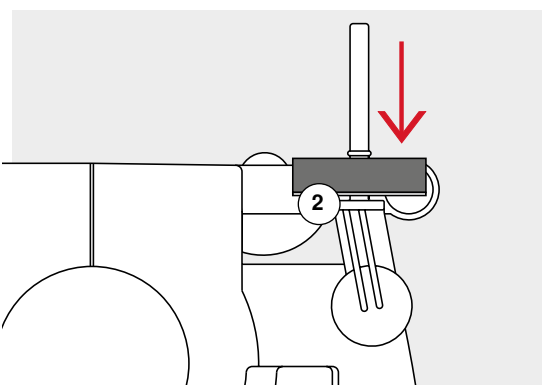

- use foam pad **2** for stability with all thread spools

Winding a bobbin

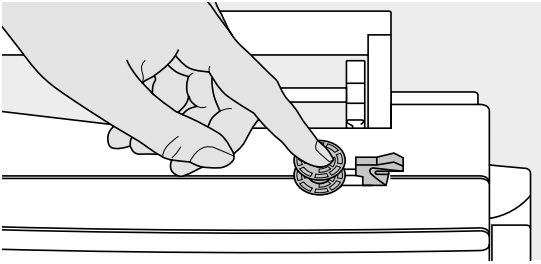

- turn power switch to «I» (on)
- place empty bobbin on spindle

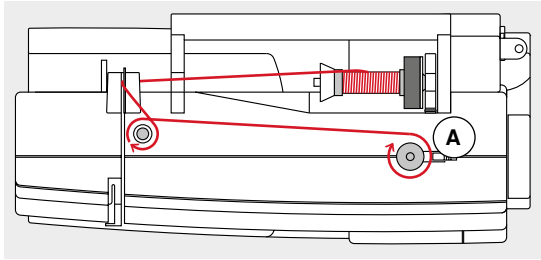

- place foam pad on the spool pin
- place thread on the spool pin
- attach appropriate spool disc
- following the direction of the arrow, take the thread through the rear guide and round the pre-tension stud
- wind the thread two to three times around the empty bobbin
- cut off any excess thread on the thread cutter **A**



Appropriate spool disc

Diameter of thread spool determines disc size. There must be no gap between the disc and the spool.

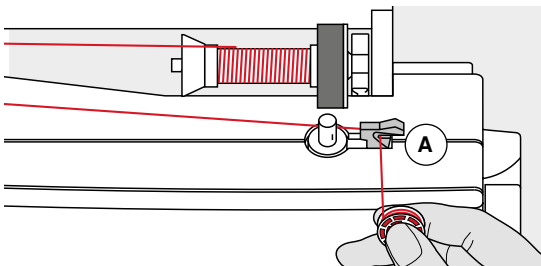

- push engaging lever **A** against bobbin
- ▶ the winder works automatically
- ▶ the Display to wind the bobbin is opened
- move the round knob in the Display to the left/right or
- turn the stitch width knob (see page 10)
- ▶ the winding speed is altered
- ▶ the motor will stop automatically when the bobbin is full
- ▶ the Display is closed
- remove bobbin and
- pull the thread over thread cutter **A** to cut it

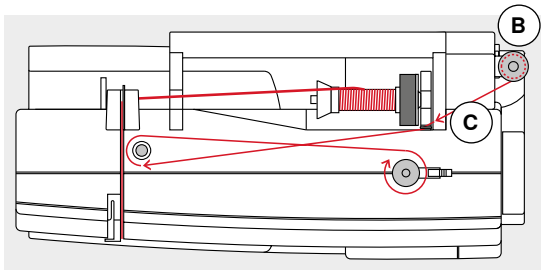

Bobbin winding while sewing

- attach foam pad on the vertical spool pin **B**
- place thread on the vertical spool pin
- following the direction of the arrow, take the thread through the thread guide **C** and
- guide around the pre-tension stud

Then proceed as mentioned above.

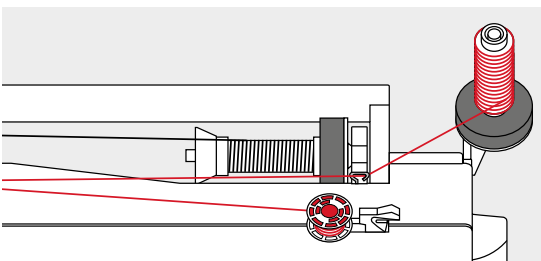

It is recommended to reduce the winding speed when winding from the vertical spool pin.

Inserting a bobbin/Threading lower thread

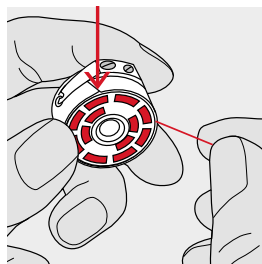
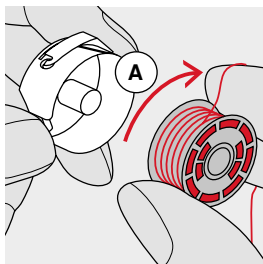

- insert the bobbin so that the thread runs clockwise **A**
- pull the thread from the right into the slot

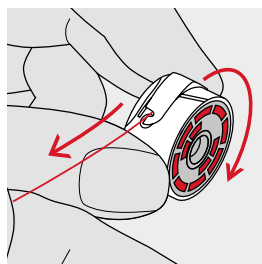
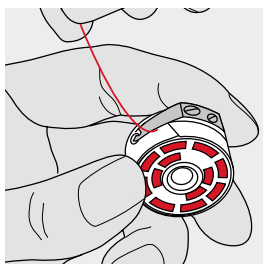

- pull the thread to the left under the spring
- until it lies in the T-shaped slit at the end of the spring
- pull the thread
 - ▶ the bobbin must turn clockwise

Exchanging bobbin case

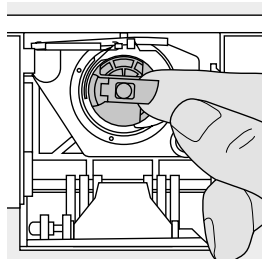

Removing the bobbin case

- raise the needle
- turn power switch to «0» (off)
- open bobbin cover
- grasp the latch of the bobbin case
- remove the bobbin case

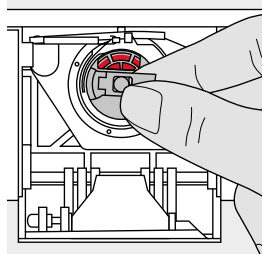

Inserting the bobbin case

- hold the bobbin case latch
- Opening of the bobbin case points up.
- insert the case so that it clicks into place

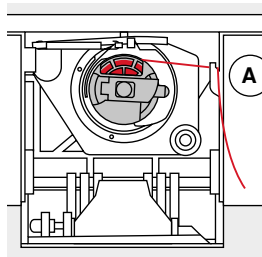

Bobbin thread cutter

- pull the thread over thread cutter **A** to cut it
- close the cover

Threading the upper thread

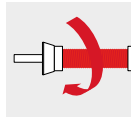

- raise the needle and presser foot
- turn power switch to «0» (off)
- place foam pad on the spool pin
- place spool on pin so that the thread unwinds clockwise
- attach appropriate spool disc

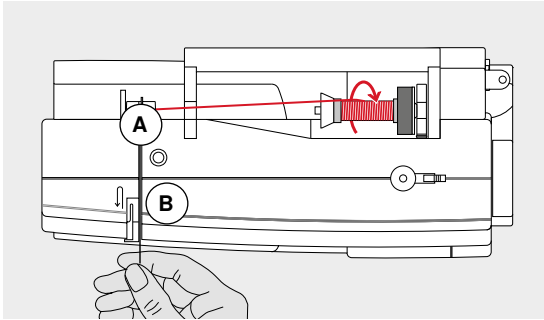

- take thread through rear guide **A**
- then into slit of upper thread tension **B**

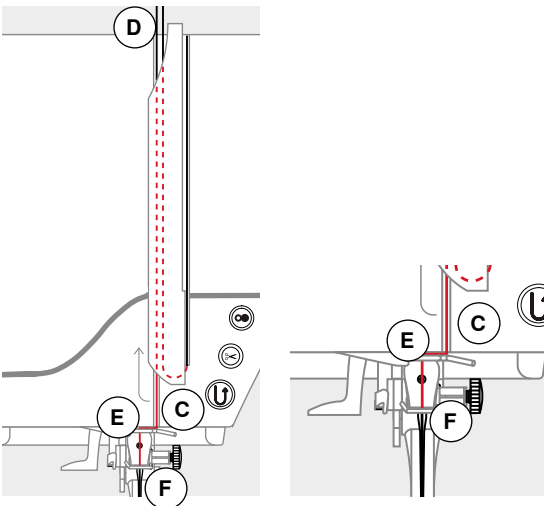

- pull thread down to the right of the take-up cover and around **C**
- take thread up to the left of the cover and around **D**, placing it in the take-up lever
- take thread down and through guides **E** and **F**
- thread the needle (see page 18)



Appropriate spool disc

Diameter of thread spool determines disc size. There must be no gap between the disc and the spool.

Changing the needle

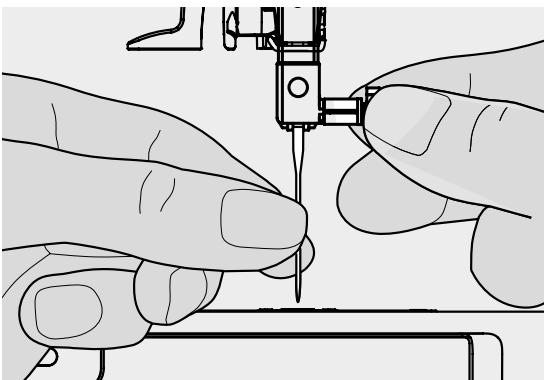

Removing the needle

- raise the needle
- lower or remove presser foot (see page 18)
- turn power switch to «0» (off)
- loosen the needle clamp screw
- pull the needle down to remove

Inserting the needle

- flat side of needle to the back
- insert the needle as far as it will go
- tighten needle clamp screw

Threading the double needle

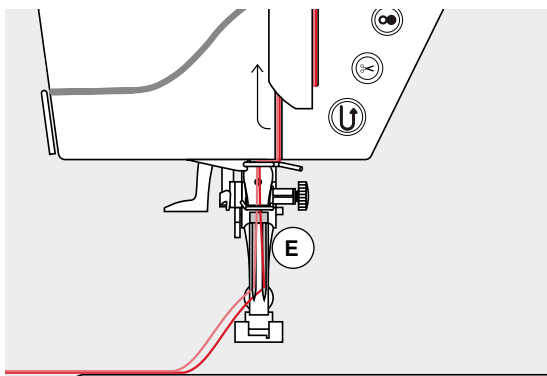
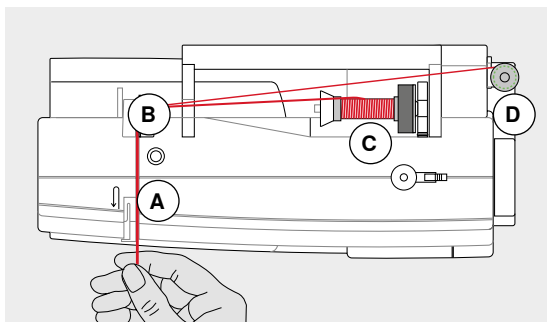

Threading the first thread

- turn power switch to «0» (off)
- insert double needle
- raise the needle and presser foot
- place foam pad on the spool pin
- place thread spool **C** on horizontal spool pin
- attach appropriate spool disc
- take thread through rear guide **B**
- guide the thread to the front in the slit and past the tension disc **A** on the **right** side
- guide the thread to the needle as usual and
- thread the **right** needle manually

Threading the second thread

- place foam pad on vertical spool pin
 - place the second thread spool **D** on the vertical spool pin
 - take thread through rear guide **B**
 - guide the thread to the front in the slit and past the tension disc **A** on the **left** side
 - guide the thread to the needle as usual and
 - thread the **left** needle manually
- Threads **E** must not be twisted together.



When using the vertical spool pin, always add a foam pad. This prevents the thread from twisting around the spool pin.

Threading the triple needle

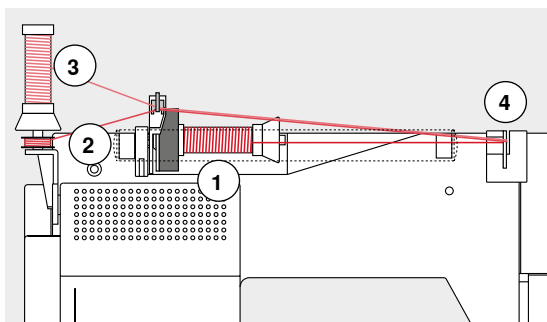

Two thread spools and one full bobbin are needed.

- insert triple needle
- place one thread spool **1** on horizontal spool pin
- place second thread spool **3** and the bobbin **2**, separated by a spool disc, on vertical spool pin (both spools must to turn in the same direction)
- thread as usual and
- guide **two** threads on the **left** side of the tension disc **4** and **one** thread past the **right** side
- guide threads to the needle as usual
- and thread every needle manually



By using the additional eyelet for metallic and silk threads (optional accessory) the thread release from the stacked spool/bobbin can be enhanced.

Thread needle

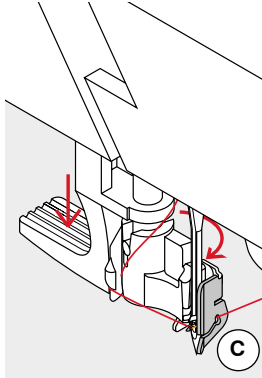
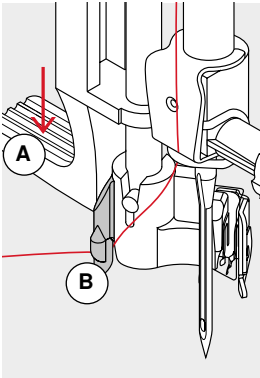

Position the needle by pressing the foot control once (1 stitch).

- raise the needle
- lower the presser foot
- turn power switch to «0» (off)
- hold thread to the left and back
- press lever **A** down and hold it
- guide thread around the hook **B** to the right in front of the needle
- put the thread from the front into the guide **C** until it catches in the wire hook

- release lever **A**
- ▶ needle is threaded
- pull the thread to the back and

- put the thread under the foot and pull it from front to back over the thread cutter on left side of the head frame **D**, cut
- Threads release automatically as soon as the first stitch is sewn.

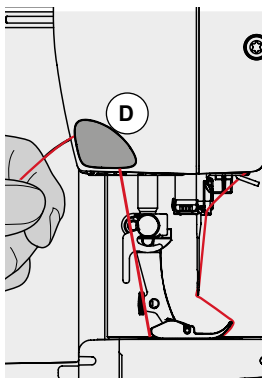
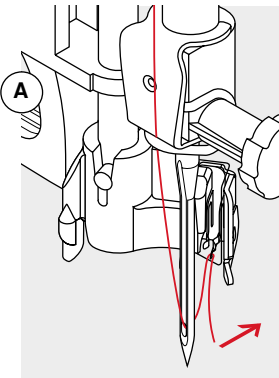

Changing the presser foot

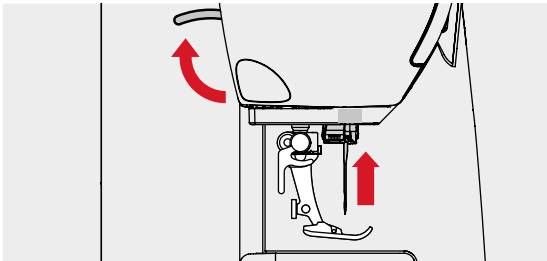

Removing the presser foot

- raise the needle and presser foot
- turn power switch to «0» (off)

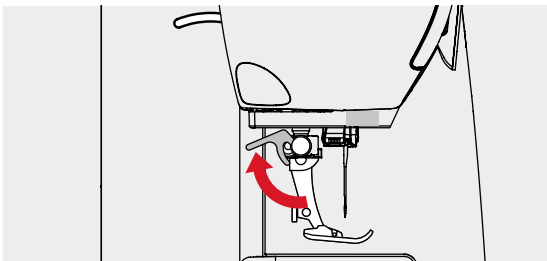

- raise the clamping lever
- remove the presser foot

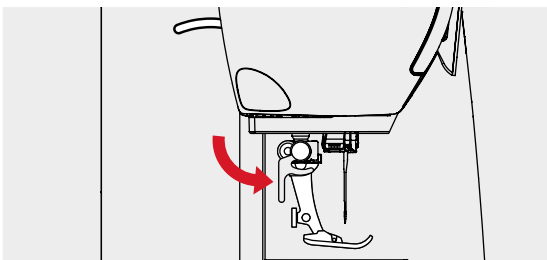

Attaching the presser foot

- guide the presser foot upwards over the cone
- press the clamping lever down

Stitch plate

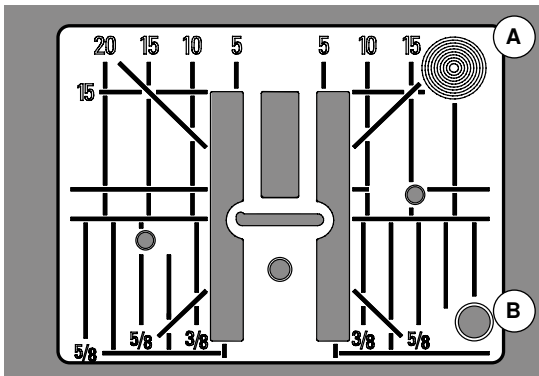

Markings on the stitch plate

- the stitch plate is marked with vertical, horizontal and diagonal lines in **mm** and **inches**
- the lines help to guide the fabric for sewing seams and precise topstitching, etc.
- the horizontal markings are helpful for sewing corners and buttonholes, etc.
- the diagonal markings are useful for quilting
- needle insertion point is position «0» (center needle position)
- the vertical measurements correspond to the distance between the needle and the line
- measurements are marked to the right and to the left of center needle position

Removing the stitch plate

- press «Feed dog»-button (see page 11)
- ▶ the feed dog is lowered
- turn power switch to «0» (off)
- remove presser foot and needle
- press the stitch plate down at the right back corner **A** until it flips up
- remove the stitch plate

Replacing the stitch plate

- place the stitch plate over the opening **B**
- press down until it clicks into place
- press «Feed dog»-button
- ▶ the feed dog is raised as soon as the first stitch is sewn

Thread tension



Higher upper thread tension = the upper thread is tightened, which pulls the lower thread up to the topside of fabric.
Lower upper thread tension = the upper thread is loosened, which enables it to be pulled to the backside of the fabric.

Basic settings are applied automatically when a stitch pattern or program is selected.

The upper thread tension is set optimally at the BERNINA factory and the sewing computer has been tested. Metrosene-/Seralon thread size 100/2 (Company Mettler, Switzerland) is used for upper and lower thread.

In case of using other types of sewing or embroidery threads, the optimal tension may vary. Therefore it may be necessary to adjust the upper thread tension according to the fabric and the desired stitch pattern.

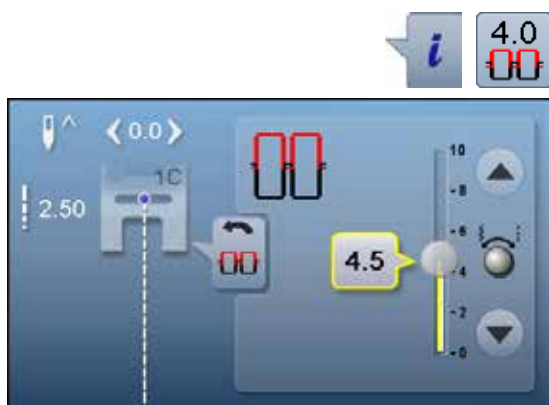

- touch «i»-icon
- touch «Upper thread tension»-icon

Changing the upper thread tension

- ▶ the optimal stitch formation (stitch formation in the fabric) is visible
- ▶ the white bar within the scale and the number in the icon show the basic setting
- touch arrow icon up/down or
- turn stitch width or stitch length knob to the left or to the right or
- move the round knob in the Display using the finger or the touch pen
- ▶ upper thread tension is tightened or loosened
- ▶ the alteration of the upper thread tension is visible within the scale (yellow) and in the yellow-framed icon
- ▶ basic setting remains visible (white)
- ▶ the alteration of the upper thread tension only affects the selected stitch



- touch «Back»-icon
- ▶ the setting is saved and the Display closes

Reset settings

- touch the yellow-framed icon
- ▶ basic setting is reset
- switch off the sewing computer
- ▶ any alterations are deleted

Adjusting presser foot pressure

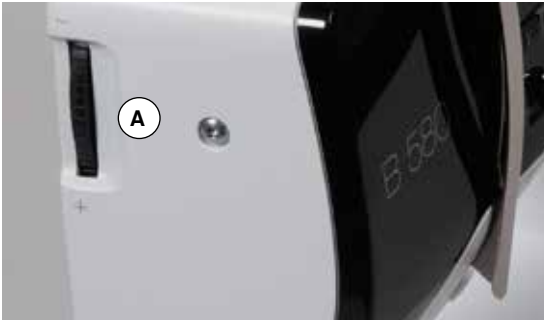

The presser foot pressure is adjusted by the presser foot pressure adjustment wheel **A** on the left side of the headframe.

Pressor foot pressure

Basic setting = 46

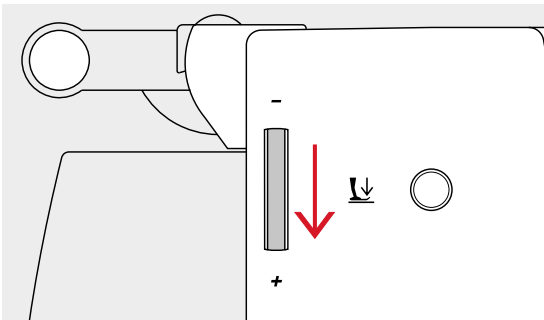

Increasing the pressor foot pressure

- for sturdy material e.g. denim
- improves the fabric feed

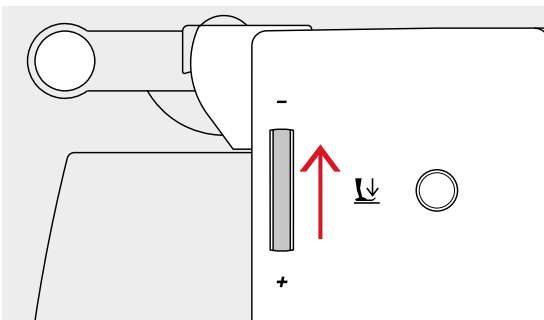

Reducing pressor foot pressure

- for jersey fabrics and loose knits
- to prevent fabric from stretching
- adjust pressure so that the fabrics feeds correctly



- touch «i»-icon
- touch «Pressor foot pessure»-icon

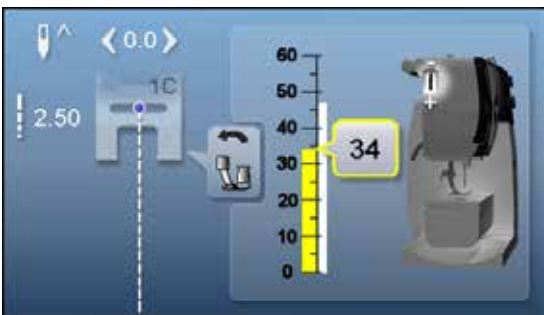

Display pressor foot pressure

- ▶ opens the «Pressor foot pressure»-display
- ▶ alterations of the pressor foot pressure are visible within the scale (yellow) and in the yellow-framed icon
- ▶ basic setting remains visible (white)

Feed dog

Feed dog lowered/ready to sew



«Feed dog»-button **A** flush with housing.
▶ feed dog is ready to sew

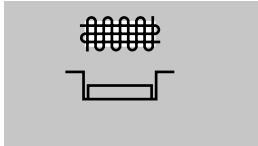

«Feed dog»-button **A** pressed.
▶ feed dog is lowered
For free-motion sewing (darning, embroidery, quilting, etc.).

Feed Dog and Fabric Feed

With each stitch the feed dog moves forward by one step. The length of this step is determined by the stitch length selected.

With an extremely short stitch length, the steps are also very short. The fabric moves away from the foot quite slowly, even at full sewing speed. e.g. button-holes, satin stitch and decorative stitches are all sewn with a very short stitch length.

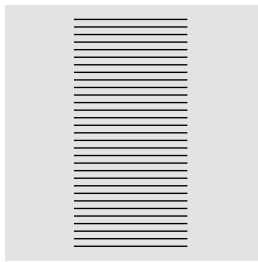

Let the fabric feed evenly.

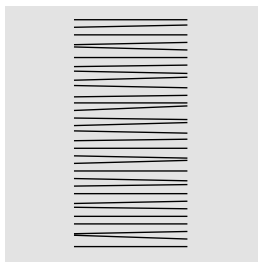
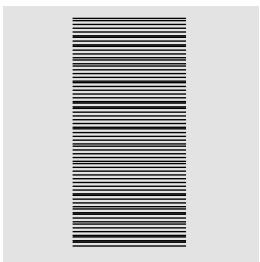

ATTENTION!

Pulling, pushing or holding back the fabric can result in damages of the needle and stitch plate.

Pulling, pushing or holding back the fabric will result in uneven stitches.

Important facts about thread and needle

Thread

The thread is chosen accordingly to the purpose. For a perfect sewing result, thread and fabric quality play an important role. It is recommended to use quality brands.

Cotton threads

- cotton threads have the advantage of being a natural fiber and therefore are especially suitable for sewing cotton fabrics
- if cotton thread is mercerized, it has a slight sheen that is not lost with washing

Polyester threads

- polyester thread has a high tensile strength and is particularly colorfast
- polyester threads are more flexible and are recommended where a strong and elastic seam is required

Rayon threads

- rayon threads are made of natural fibers and have a brilliant sheen
- rayon threads are suitable for decorative stitches and achieve a more beautiful effect

Needle, thread and material

ATTENTION!

Check the needle condition.

As a guide: Replace the needle before starting a new sewing project. A defective needle does not only damage the sewing project but also the sewing computer.

Care must be taken when choosing needle and thread.

The correct needle size depends on the selected thread and fabric. The fabric weight and type determine the thread weight, needle size and point form.

Needles, threads

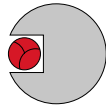

Correct needle/Thread combination

When sewing, the thread should travel smoothly down the long groove on the front of the needle.

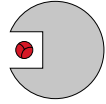

Too thin thread or too thick needle

The thread has too much clearance in the long groove. Skipped stitches and damage to the thread can occur.

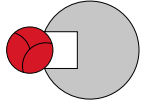

Too thick thread or too fine needle

The thread rubs on the edges of the long groove and can get jammed. This can cause thread breakage.



Guidelines





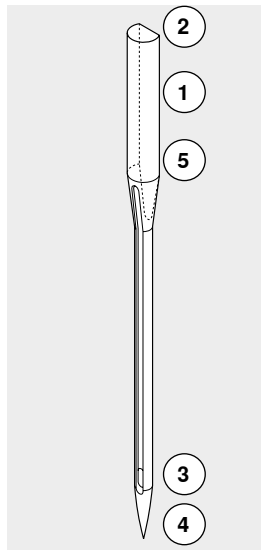

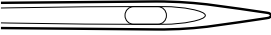
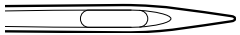
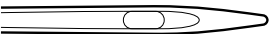
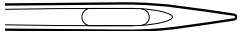

Material and thread	Needle size
Light weight materials: Fine thread (darning thread, embroidery thread)	70-75
Medium weight materials: Sewing thread	80-90
Heavy weight materials: Sewing thread (quilting thread, topstitching)	100, 110, 120

130/705 H-S/70

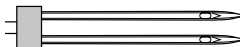
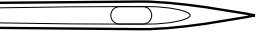

- 1 **130** Shank length
- 2 **705** Flat shank
- 3 **H** Needle scarf
- 4 **S** Needle point (here e.g. medium ball point)
- 5 **70** Needle size (shank diameter)

Overview needles

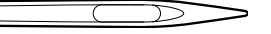
<p>Universal 130/705 H/60-100</p>  <p>Normal point, slightly rounded</p> <p>For nearly all natural and synthetic fabrics (woven and knitted)</p>	<p>Metafil 130/705 H-MET/75-80 or H-SUK/90-100</p>  <p>Large eye</p> <p>Sewing with metallic threads</p>
<p>Jersey/Stretch 130/705 H-S, H-SES, H-SUK/70-90</p>  <p>Ball point</p> <p>Jersey, knit and stretch material</p>	<p>Cordonnet (Topstitching) 130/705 H-N/80-100</p>  <p>Small ball point, long eye</p> <p>Topstitching with thick thread</p>
<p>Leather 130/705 H-LL, H-LR/90-100</p>  <p>With cutting point</p> <p>All types of leather, synthetic leather, plastic, sheeting</p>	<p>Wing needle (Hemstitch needle) 130/705 HO/100-120</p>  <p>Wide needle (wing)</p> <p>Hemstitching</p>
<p>Jeans 130/705 H-J/80-110</p>  <p>Very fine sharp point</p> <p>Heavy weight fabrics such as jeans, canvas, overalls</p>	<p>Double wing needle 130/705 H-ZWI-HO/100</p>  <p>For special effects with hemstitch embroidery</p>
<p>Microtex 130/705 H-M/60-90</p>  <p>Especially fine sharp point</p> <p>Micro fiber fabrics and silk</p>	<p>Double needle 130/705 H-ZWI/70-100</p>  <p>Needle distance: 1.0/1.6/2.0/2.5/3.0/4.0/6.0/8.0</p> <p>Visible hems in stretch fabrics, pintucks, decorative sewing</p>
<p>Quilting 130/705 H-Q/75-90</p>  <p>Fine sharp point</p> <p>Straight and topstitching</p>	<p>Triple needle 130/705 H-DRI/80</p>  <p>Needle distance: 3.0</p> <p>Visible hems in stretch fabrics; Decorative sewing</p>
<p>Embroidery 130/705 H-SUK/70-90</p>  <p>Large eye, slight ball point</p> <p>Embroidery on all natural and synthetic fabrics</p>	

Overview «Function»-buttons sewing computer



«Quick reverse»-button

- secures the seam beginning and end: sews in reverse as long as the button is pressed
- used to program the buttonhole length
- used to program the darning length
- used to determine end of stitching in straight stitch Securing stitch No. 5
- used for securing in Quilters securing program No. 1324



«Start/Stop»-button

- starts and stops the sewing computer when operating it **with** or **without** foot control
- starts and stops the BSR-Function if the BSR foot is attached and activated



«Automatic thread cutter»-button

- upper and lower threads are automatically cut
- 2-6 securing stitches can be programmed in the setup program. These are sewn before the thread is cut

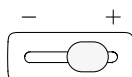

Speed control

- sewing-/embroidery speed is infinitely variable with the slide



«Needle stop»-button

- touch button
- ▶ the needle is raised or lowered in the same way as by sinking the heel back on the foot control



Programmable «Pattern end/Securing»-button

- touch button before the sewing starts or during sewing
- ▶ single pattern is secured at the end, with the selected number of stitches programmed
- touch button before the sewing starts or during sewing of a combination
- ▶ the combination is secured at the end, with the selected number of stitches programmed
- the number and type of the securing stitches can be programmed in the setup program

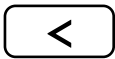

«Needle position»-buttons

- press the left button
- ▶ needle moves to the left
- press the right button
- ▶ needle moves to the right
- keep button pressed
- ▶ quick change
- total of 11 needle positions (5 left, 5 right, 1 center)

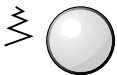

Stitch width and Stitch length Knobs (Multi-function)

- to adjust stitch width or stitch length
- to alter thread tension
- to set the buttonhole slit width or the button size
- to adjust the balance
- various alterations in the setup program
- various alterations when embroidering

Overview Main Display

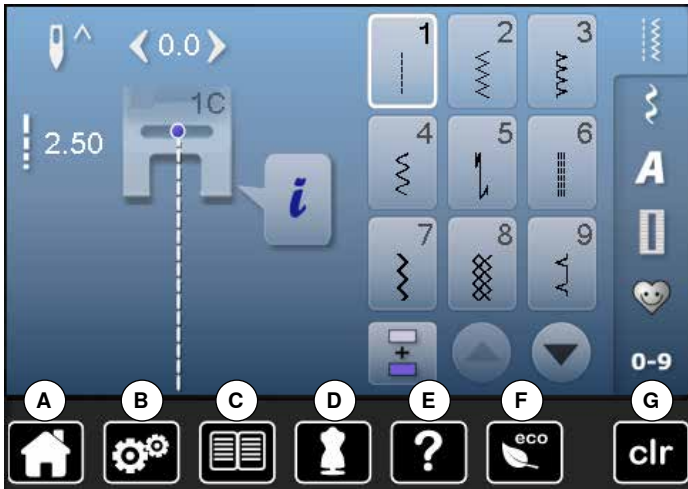

System settings

- A Home
- B Setup Program
- C Tutorial
- D Creative consultant
- E Help
- F ECO
- G Deleting settings

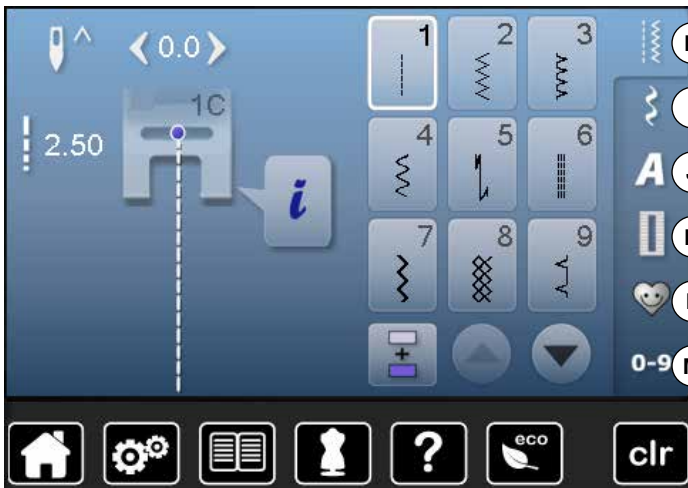

Menu Selection

- H Practical stitches
- I Decorative stitches
- J Alphabets
- K Buttonholes
- L Personal program/Memory
- M Stitch selection by number

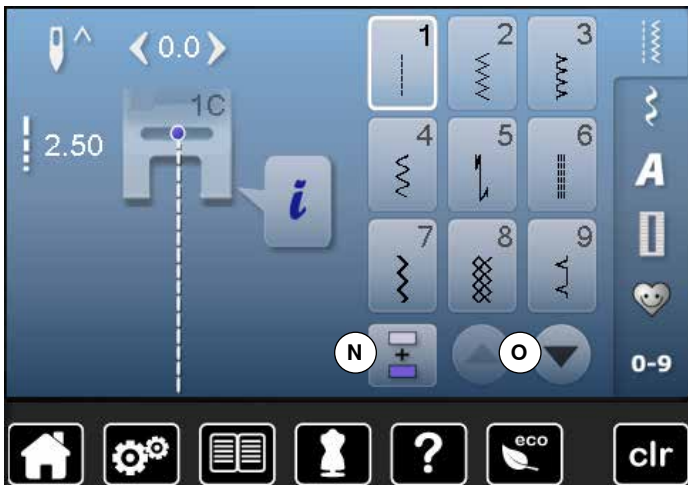

Selection

- N Single and combi mode
- O Scroll up/down

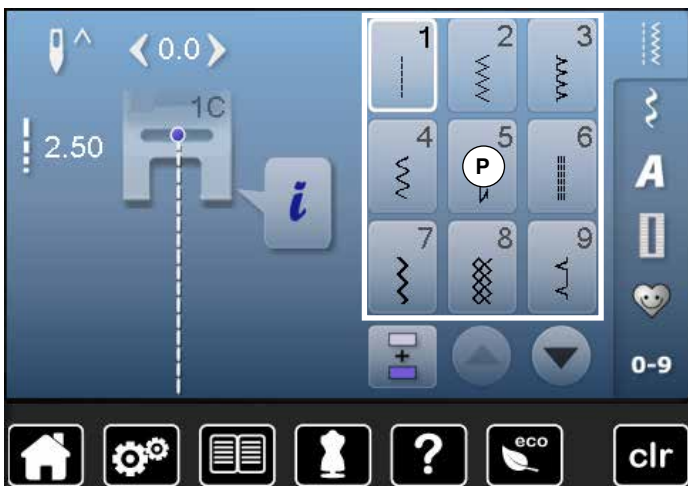

Stitch Pattern selection

- P Stitch pattern selections

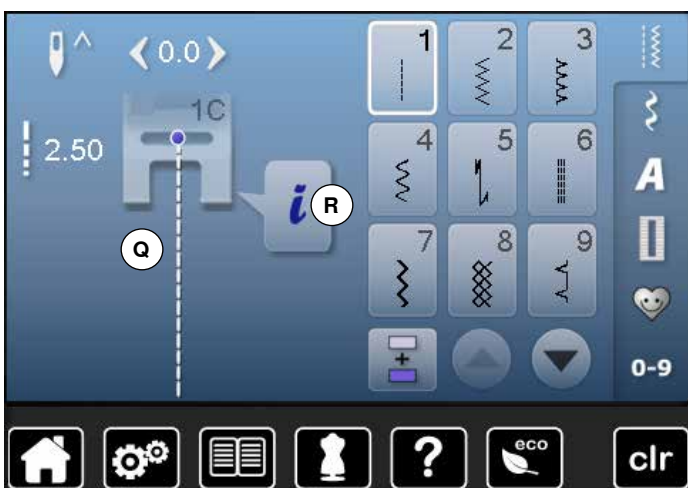

Stitch Pattern Display

- Q Display of the stitch pattern selected
- R Information

Overview Sewing functions



- touch «i»-icon
- function Display appears

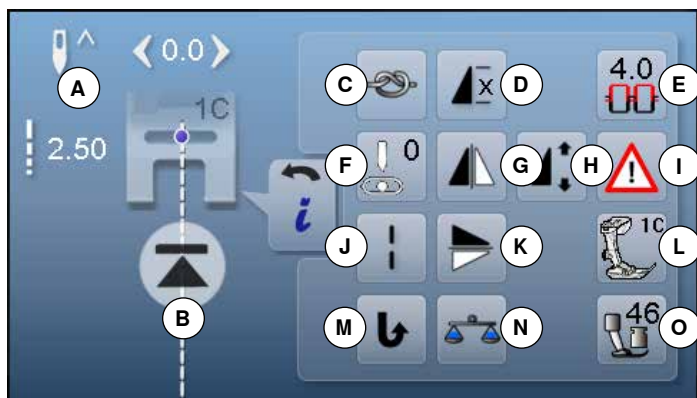

Functions

- A** Needle stop up/down
- B** Pattern begin
- C** Securing
- D** Pattern repeat
- E** Upper thread tension
- F** Needle position
- G** Mirror Image (Left/Right)
- H** To alter pattern length/stitch density
- I** Security program
- J** Long stitch
- K** Mirror image (Up/Down)
- L** Presser foot indicator
- M** Permanent reverse sewing
- N** Balance
- O** Presser foot pressure

General functions



Information

- touch icon
- ▶ another Display is opened



Back

- touch icon
- ▶ goes back to the previous Display
- ▶ all changes are saved



Confirm selection

- touch icon
- ▶ activates or confirms alteration/selection



Leaving the active Display

- touch icon
- ▶ the Display is closed
- ▶ goes back to the previous Display



Needle stop up/down

- touch icon
- ▶ the arrow on the Display points down
- ▶ the sewing computer stops with needle down
- touch the icon again
- ▶ the arrow on the Display points up
- ▶ the sewing computer stops with needle up



Pattern begin

- the function appears when the sewing computer is stopped while sewing a single stitch or a stitch combination
- ▶ the needle moves to the beginning of a stitch pattern or program



Securing

- touch icon before sewing
- ▶ the single stitch is secured with four securing stitches at the beginning
- touch icon while sewing a single pattern
- ▶ the single stitch is secured at the end
- ▶ the sewing computer stops
- to program the securing function within a stitch combination
- any single stitch of the combination can be secured at the begin or at the end



Pattern repeat

- touch icon 1x
- ▶ number 1 appears: the sewing computer stops at the end of a single stitch or a stitch combination
- touch icon 2-9x
- ▶ numbers 2-9 appear: the sewing computer stops after the selected repeats of single stitches or a stitch combination



Upper thread tension

- change upper thread tension
- ▶ the respective value is visible in the icon



Needle stop position up and «Quick Reverse»-button



If the «Quick Reverse»-button is pressed while sewing or after stopping (e.g. zig-zag) with programmed needle stop up, the sewing computer sews one stitch forward before it switches to sewing in reverse.



Needle stop position down and «Quick Reverse»-button



If the «Quick Reverse»-button is pressed after stopping (e.g. zig-zag) with programmed needle stop down, the sewing computer switches to sewing in reverse immediately.



Altering pattern length

- move the round knob in the Display using the touch pen or the finger
 - ▶ pattern length (Standard = 100%) is infinitely variable
 - extend or shorten in 1%-steps using the arrow icons or
 - touch «Pattern length»-icon
 - ▶ the pattern length is extended in 100%-steps
- Maximum length is 1000%, shortest length is 10%. Some stitch patterns are limited and cannot be extended to 1000%.

Altering stitch density

Certain decorative stitches (e.g. No. 401) allow an alteration of the stitch density. The set stitch pattern length will not be affected.

- touch arrow icon «up»
- ▶ the stitch density is reduced in 0.05mm steps
- ▶ the stitch distance is enlarged
- touch arrow icon «down»
- ▶ the stitch density is increased in 0.05mm steps
- ▶ the stitch distance is reduced



Needle position

- move the needle position to the left or to the right touching the arrow buttons left/right or using the touch pen or with the finger
- keep arrow button pressed
- ▶ quick moving of the needle
- ▶ the needle position is displayed in the yellow-framed icon
- touch yellow-framed icon
- ▶ the needle moves to the middle (position 0)



Mirror image (Left/Right)

The sewing computer sews the stitch pattern horizontally mirrored, left/right referring to the sewing direction.



Security program

- touch icon
 - touch «Needle»- or «Stitch plate»-icon
- Overview Needle:
- touch desired «Needle»-icon
 - ▶ stitch width is limited automatically
 - ▶ this prevents the inserted special needle (double needle etc.) from hitting the presser foot or the stitch plate = no needle breakage
 - ▶ numbers in the needle icons show the needle distance in mm
 - touch «Standard needle»-icon
 - ▶ the standard needle is activated again
 - ▶ stitch width limitation is deactivated

Overview Stitch plates:

- touch the desired «Stitch plate»-icon
- ▶ stitch width is limited automatically
- ▶ this prevents the inserted needle from hitting the presser foot or the stitch plate = no needle breakage

The function remains active even when the sewing computer is turned off and on.



Long stitch

- the sewing computer sews every **second** stitch (max. stitch length 10mm)
- applicable for practical and decorative stitches
- **Exception:** buttonholes, alphabets



Mirror image up/down

The sewing computer sews the stitch pattern vertically mirrored up/down referring to the sewing direction.



Presser foot indicator

- touch icon
- ▶ the Display is opened showing the optional presser feet for the selected stitch pattern
- touch «Back»-icon
- ▶ the Display is closed



Permanent reverse sewing

The sewing computer sews the selected stitch pattern in reverse.



Balance

Balances forward and reverse stitches.



Pressor foot pressure

- ▶ The pressor foot pressure is set via the adjustment wheel on the left side of the headframe.
- ▶ the respective value is visible in the icon

Overview Functions buttonholes



- touch «Buttonhole»-button
- select the buttonhole
- touch «i»-icon

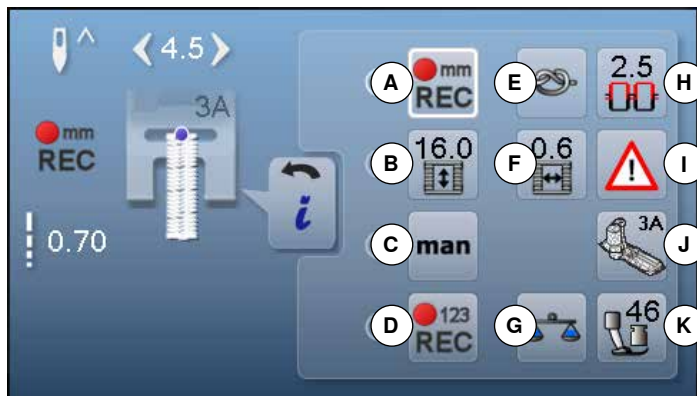

Altering the buttonhole

- A Programs the buttonhole length
- B Buttonhole length direct entry
- C Manual buttonhole
- D Stitch counter buttonhole
- E Securing
- F Buttonhole slit width
- G Balance
- H Upper thread tension
- I Security program
- J Presser foot indicator
- K Presser foot pressure

General functions



Information

- touch icon
- ▶ another Display is opened



Back

- touch icon
- ▶ goes back to the previous Display
- ▶ all changes are saved



Confirming selection

- touch icon
- ▶ activates or confirms alteration/selection



Leaving the active Display

- touch icon
- ▶ the Display is closed
- ▶ goes back to the previous Display



Programming buttonhole length

- ▶ the icon is white-framed after a buttonhole has been selected
- determine the buttonhole length while sewing with the «Quick reverse»-button or
- program the indicated length directly in the icon below by touching the icon
- ▶ function becomes inactive after programming the length
- if a new length is to be programmed, touch the icon again



Buttonhole length direct entry

Enter the buttonhole length via the stitch width or stitch length knob. Size in mm.



Manual buttonhole

- sew a manual buttonhole in 5 or 7 steps (depending on buttonhole type)
- select every step by touching the arrow icons below the indicated buttonhole



Stitch counter buttonhole

- Having sewn the desired length of the 1st bead, then
- press «Quick reverse»-button
- Having sewn the desired length of the 2nd bead, then
- press «Quick reverse»-button
- ▶ Display shows «auto»
- ▶ the buttonhole is programmed



Securing

- touch icon before sewing
- ▶ the buttonhole is secured with four securing stitches at the beginning
- touch icon while sewing a buttonhole
- ▶ the buttonhole is secured at the end
- ▶ the sewing computer stops



Buttonhole slit width

- set the buttonhole slit width to between 0.1mm and 2.0mm using the stitch width or the stitch length knob or the arrow icons



Balance

Balances forward and reverse stitches.



Upper thread tension

- change upper thread tension
- ▶ the respective value is visible in the icon



Security program

- touch icon
- touch «Needle»- or «Stitch plate»-icon

Overview Needles:

- touch desired «Needle»-icon
 - ▶ the stitch width is limited automatically
 - ▶ this prevents the inserted special needle (double needle etc.) from hitting the presser foot or the stitch plate = no needle breakage
 - ▶ numbers in the needle icons indicate the needle distance in mm
- touch the «Standard needle»-icon
 - ▶ the standard needle is activated again
 - ▶ stitch width limitation is deactivated

Overview Stitch plates:

- touch desired «Stitch plate»-icon
 - ▶ the stitch width is limited automatically
 - ▶ prevents the inserted needle from hitting the presser foot or the stitch plate = no needle breakage

The function remains active even when the sewing computer is turned off and on.



Presser foot indicator

- touch icon
- ▶ the recommended presser foot is displayed
- ▶ the active Display shows the optional presser feet for the selected stitch pattern
- touch «Back»-icon
- ▶ the Display is closed



Presser foot pressure

- The presser foot pressure is set via the adjustment wheel on the left side of the headframe.
- ▶ the respective value is visible in the icon

Overview Functions Alphabets



- touch «Alphabet»-button
- select Alphabet
- touch «i»-icon

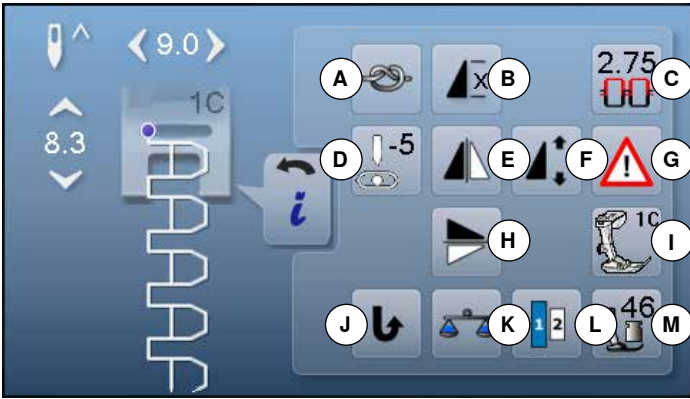

Altering Alphabet

- A Securing
- B Pattern repeat
- C Upper thread tension
- D Needle position
- E Mirror image (Left/Right)
- F To alter pattern length
- G Security program
- H Mirror image down/up
- I Presser foot indicator
- J Permanent reverse sewing
- K Balance
- L Lettering size in alphabets
- M Presser foot pressure

General Functions



Information

- touch icon
- ▶ opens another Display



Back

- touch icon
- ▶ goes back to the previous Display
- ▶ all changes are saved



Confirm selection

- touch icon
- ▶ activates or confirms alteration/selection



Leaving the active Display

- touch icon
- ▶ closes Display
- ▶ shows the previous Display



Securing

- touch icon before sewing
- ▶ single stitch is secured at the begin with four securing stitches
- touch icon while sewing a single stitch
- ▶ the single stitch is secured at the end
- ▶ the sewing computer stops
- to program the securing function within a pattern combination
- each individual pattern of the combination can be secured at the start or the end



Pattern repeat

- touch icon 1x
- ▶ number 1 appears: the sewing computer stops at the end of an individual stitch or stitch combination
- touch icon 2-9x
- ▶ numbers 2-9 appear: the sewing computer stops at the end of a stitch or a stitch combination after the number of repeats selected



Upper thread tension

- change upper thread tension
- ▶ the respective value is visible in the icon



Needle position

- move the needle to the left or to the right using the arrow icons left/right or with the touch pen or with the finger
- keep arrow icon pressed
- ▶ quick movement of the needle
- ▶ the needle position is displayed in the yellow-framed icon
- touch yellow-framed icon
- ▶ moves the needle to the middle (Position 0)



Mirror image (Left/Right)

The sewing computer sews the stitch pattern horizontally mirrored, left/right referring to the sewing direction.



Altering pattern length

- move the round knob in the Display using the touch pen or the finger
 - ▶ pattern length (Standard = 100%) is infinitely variable
 - extend/shorten in 1%-steps with the arrow icons or
 - touch «Pattern length»-icon
 - ▶ pattern length is extended in 100%-steps
- Maximum length is 200%, shortest length is 10%.



Security program

- touch icon
 - touch «Needle»- or «Stitch plate»-icon
- Overview Needle:
- touch desired «Needle»-icon
 - ▶ stitch width is limited automatically
 - ▶ this prevents the inserted special needle from hitting the presser foot and the stitch plate = no needle breakage
 - ▶ numbers in the needle icons indicate the needle distance in mm
 - touch «Standard needle»-icon
 - ▶ Standard needle is activated again
 - ▶ stitch width limitation is deactivated
- Overview Stitch plates:
- touch the desired «Stitch plate»-icon
 - ▶ stitch width is limited automatically
 - ▶ this prevents the needle from hitting the presser foot and the stitch plate = no needle breakage

The function remains active even when the sewing computer is turned off and on.



Mirror image (Up/Down)

The sewing computer sews the stitch pattern vertically mirrored, up/down referring to the sewing direction.



Presser foot indicator

- touch icon
- ▶ shows recommended presser foot
- ▶ the active Display shows optional presser feet for the selected stitch pattern
- touch «Back»-icon
- ▶ the Display is closed



Permanent reverse sewing

The sewing computer sews the selected stitch pattern in permanent reverse.



Balance

Balances forward and reverse stitches.



Lettering size in alphabets

- select alphabet
- ▶ letter size is 9mm
- touch icon
- ▶ activates number «2»
- ▶ the font size is reduced



Presser foot pressure

The presser foot pressure is set via the adjustment wheel on the left side of the headframe.

- ▶ the respective value is visible in the icon

Overview Functions Combi mode



- touch «Combi mode»-icon
- select stitch pattern
- touch «i»-icon

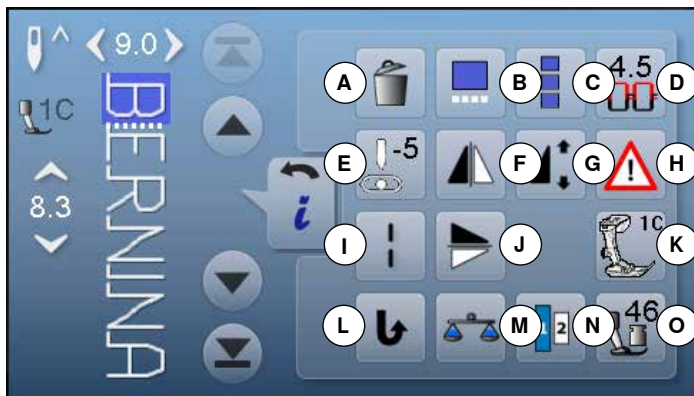

Combi mode

- A** Deleting
- B** Editing combinations at cursor position
- C** To edit the whole combination
- D** Upper thread tension
- E** Altering the needle position
- F** Mirror image (Left/Right)
- G** Altering the pattern length
- H** Security program
- I** Long stitch (without alphabets)
- J** Mirror image (Up/Down)
- K** Presser foot indicator
- L** Permanent reverse sewing
- M** Balance
- N** Lettering size in alphabets
- O** Presser foot pressure

General Functions



Information

- touch icon
- ▶ another Display is opened



Back

- touch icon
- ▶ goes back to the previous Display
- ▶ all changes are saved



Confirm selection

- touch icon
- ▶ activates/confirms the alteration/selection



Leaving the active Display

- touch icon
- ▶ closes Display
- ▶ goes back to the previous Display



Deleting

Deletes an individual stitch.



Editing a combination at cursor position

- touch icon
- ▶ the Display is opened



Editing the whole combination

- touch icon
- ▶ the Display is opened



Upper thread tension

- change upper thread tension
- ▶ the respective value is visible in the icon



Altering the needle position

- move the needle to the left or to the right touching the arrow icons left/right or using the touch pen or with the finger
- keep arrow icon pressed
- ▶ quick movement of the needle
- ▶ the yellow-framed icon shows the needle position
- touch yellow-framed icon
- ▶ moves the needle to the middle (Position 0)



Mirror image (Left/Right)

The sewing computer sews the stitch pattern horizontally mirrored, left/right referring to the sewing direction.



Altering pattern length

- move the round knob in the Display using the touch pen or the finger
 - ▶ pattern length (Standard = 100%) is infinitely variable
 - extend/shorten in 1%-steps with the arrow icons or
 - touch «Pattern length»-icon
 - ▶ pattern length is extended in 100%-steps
- Maximum length is 1000%, shortest length 10%. Some stitch patterns are limited and cannot be extended to 1000%.



Security program

- touch icon
- touch «Needle»- or «Stitch plate»-icon

Overview Needles:

- touch the desired «Needle»-icon
- ▶ stitch width is limited automatically
- ▶ this prevents the inserted special needle from hitting the presser foot and the stitch plate = no needle breakage
- ▶ numbers in the needle icons indicate the needle distance in mm
- touch «Standard needle»-icon
- ▶ the Standard needle is activated again
- ▶ the stitch width limitation is deactivated

Overview Stitch plates:

- touch the desired «Stitch plate»-icon
- ▶ stitch width is limited automatically
- ▶ this prevents the inserted needle from hitting the presser foot and the stitch plate = no needle breakage

The function remains active even when the sewing computer is turned off and on.



Long stitch

- the sewing computer sews every **second** stitch (max. stitch length 10mm)
- applicable for practical and decorative stitches
- **Exception:** buttonholes, alphabets



Mirror image (Up/Down)

The sewing computer sews the stitch pattern vertically mirrored, up/down referring to the sewing direction.



Presser foot indicator

- touch icon
- ▶ shows the recommended presser foot
- ▶ the active Display shows the optional presser feet for the selected stitch
- touch the «Back»-icon
- ▶ the Display is closed



Permanent reverse sewing

The sewing computer sews the selected stitch pattern in permanent reverse.



Balance

Balances forward and reverse stitches.



Lettering size in alphabets

- select alphabet
- ▶ letter size is 9mm
- touch icon
- ▶ activates number «2»
- ▶ the font size is reduced



Presser foot pressure

The presser foot pressure is set via the adjustment wheel on the left side of the headframe.

- ▶ the respective value is visible in the icon





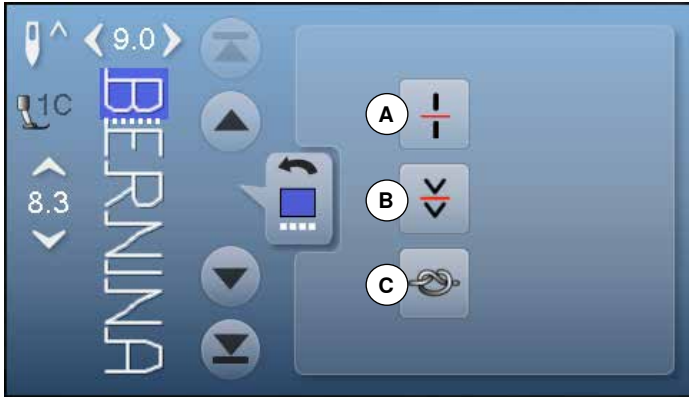

- touch «Combi mode»-icon
- select the stitch pattern
- touch «i»-icon
- touch «Cursor position»-icon



Functions

- A** Combination subdivider (1)
- B** Combination subdivider (2)
- C** Securing

General Functions

-  **Information**
 - touch icon
 - ▶ another Display is openend
-  **Back**
 - touch icon
 - ▶ goes back to the previous Display
 - ▶ all changes are saved
-  **Confirm selection**
 - touch icon
 - ▶ activates/confirmes alteration/selection
-  **Leaving the active Display**
 - touch icon
 - ▶ the Display is closed
 - ▶ goes back to the previous Display



Combination subdivider (1)

- each combination or memory folder can be subdivided into several parts
- only those parts where the cursor is located will be sewn
- to sew another part, the cursor must be placed into this part



Combination subdivider (2)

- each combination can be interrupted as desired
- after stopping, the needle moves to the next part to be sewn



Securing

- program the function within a pattern combination
- each individual pattern of the combination can be secured at the start or the end



- touch «Combi mode»-icon
- select stitch pattern
- touch «i»-icon
- touch «Edit whole combination»-icon

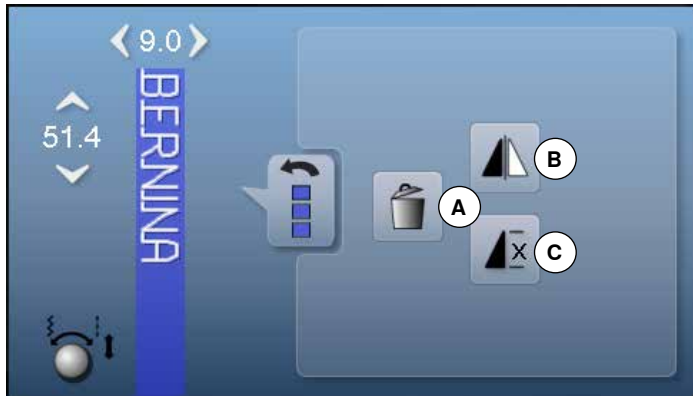

Functions

- A** Deleting
- B** Mirror Image (Left/Right)
- C** Combination repeat

General Functions



Information

- touch icon
- ▶ another Display is opened



Back

- touch icon
- ▶ goes back to the previous Display
- ▶ all changes are saved



Confirm selection

- touch icon
- ▶ activates/confirms alteration/selection



Leaving the active Display

- touch icon
- ▶ the Display is closed
- ▶ goes back to the previous Display



Deleting

Deletes the whole combination.



Mirror image (Left/Right)

The sewing computer sews the whole combination horizontally mirrored, left/right referring to the sewing direction.



Combination repeat

- touch icon 1x
- ▶ number 1 appears: the sewing computer stops at the end of a pattern combination
- touch icon 2-9x
- ▶ numbers 2-9 appear: the sewing computer stops at the end of a stitch combination after the number of repeats selected

Overview «Setup»-display

The Setup Program enables an individual adjustment of the Display surface and the settings according to your personal requirements.

After setting the sewing computer to your personal requirements, all changes made in the Setup Program are saved, even when the sewing computer is switched off.

Exceptions from this rule are outlined within the description of the function concerned in each case.



- touch «Setup Program»-button
- ▶ «Setup Program»-display is opened

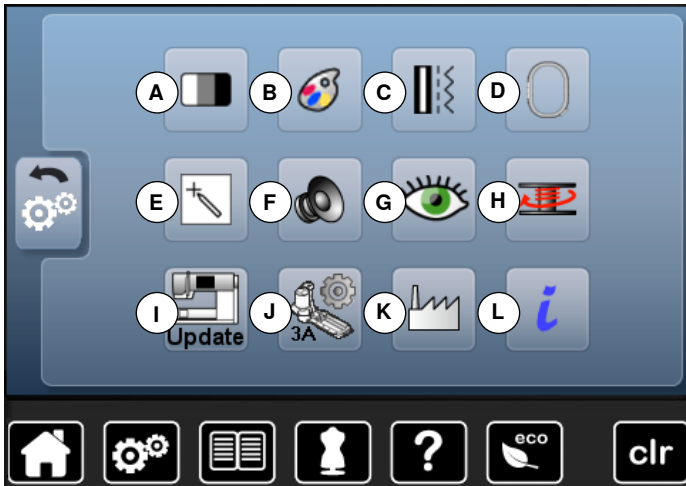

- A Display settings
- B Display color
- C Sewing settings
- D Embroidery settings
- E Display calibration
- F Audio System
- G Monitoring
- H Winding speed
- I Update sewing computer
- J Calibration buttonhole foot No. 3A
- K Basic setting
- L Information



Touch the yellow-framed icon to reset to basic setting.

Changing Display settings



- touch «Display setting»-icon

Brightness

- move the round knob in the Display to the left/right or
- turn the stitch width knob
- ▶ brightness 1 of the Display is changed
- ▶ alterations are visible in the yellow-framed icon
- ▶ a white line indicates the basic setting

Sewing light

- ▶ when icon 2 is active, the sewing light is on
- ▶ when icon 2 is inactive, the sewing light is off



Welcome text

- create or change Welcome Text 3
- The space button is below the keyboard.
- ▶ Welcome text 4 appears in the text icon above the letter keys
 - touch «Text»-icon 4
 - ▶ the entered text is completely deleted



Corrections

- touch icon
- ▶ the entered text is deleted from the right to the left

- 5 «ABC» all in upper case (Standard)
- 6 «abc» all in lower case
- 7 «Ä Å Á», «ä å á» and «@ #» upper and lower special characters
- 8 «1,2,3» numbers and mathematical characters

Selecting the Display color



- touch «Display color»-icon
- select the desired display color

Sewing settings

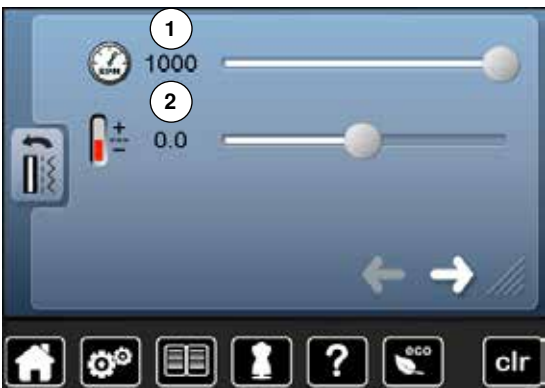

- touch «Sewing setting»-icon

Sewing speed

- move the round knob in the Display to the left/right or
- turn the stitch width knob
- ▶ alters the maximal sewing speed **1**
- ▶ the number in the yellow-framed icon indicates the stitches per minute, the basic value is indicated by a white line

Altering the upper thread tension

- move the round knob in the Display to the left/right or
 - turn the stitch length knob
 - alters the basic setting of the upper thread tension **2** at plus or minus two basic values
- 0.0 = basic setting



The alteration of the upper thread tension affects any stitch patterns and embroidery motifs and is saved even when the sewing-/ embroidery computer is switched off.



- touch icon



Automatic securing program at pattern end

- the number and type of the securing stitches of the **external** «Pattern end/ Securing»-button can be programmed
- standard = four securing stitches in the same place
- select function **3** for forward securing stitches
- via the arrow icons three to six securing stitches can be programmed

Automatic thread cutter

- ▶ if function **4** is activated, the upper and lower thread are automatically cut after sewing



- touch icon



Automatic thread cutter and securing stitches

- the number and type of the securing stitches before the thread is cut can be programmed
- standard = no securing stitches programmed
- touch function 1 for securing stitches in place or function 2 for forward securing stitches
- using the arrow icons two to six securing stitches can be programmed

Adjusting embroidery settings

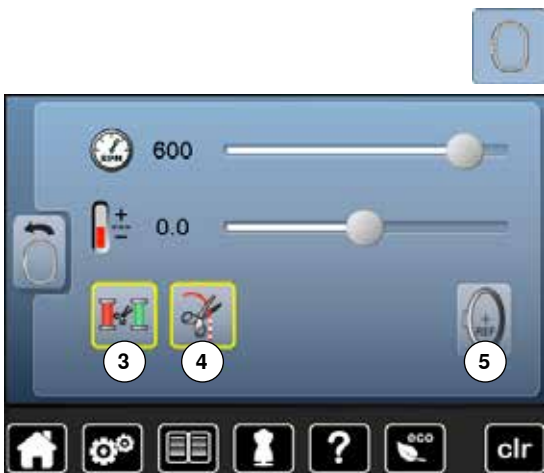

- touch «Embroidery settings»-icon

The settings for embroidery speed and the upper thread tension can be adjusted in the same way like the settings for sewing. (see page 42)

- touch icon 3
 - ▶ when changing the thread color the automatic cut of the thread is activated or deactivated
- touch icon 4
 - ▶ to turn automatic thread cutter on or off
- touch icon 5
 - ▶ to calibrate the hoop

Calibrating the hoop

The hoop calibration adjusts the needle to the center of the hoop. Adjustments can only be done if the embroidery module and the oval hoop are attached. This procedure has to be done only once as it is the same for all hoop sizes.

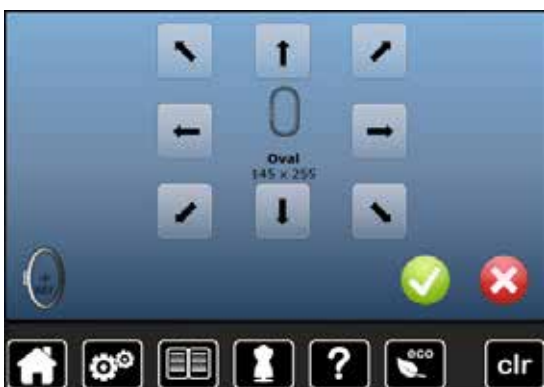

- place embroidery template into the embroidery hoop
- start the adjustment by pressing ✓
- ▶ the hoop is checked and the needle positioned to the center
- if the needle is **not** positioned exactly in the center of the embroidery template, it has to be centered by using the arrow icons
- confirm with ✓
- ▶ the adjustment is saved



Place the fabric in the embroidery hoop. The embroidery template is located well in the hoop.

Calibrating the Display



The Display calibration can be opened as follows:

- turn off the sewing-/embroidery computer
- touch the two needle positioning buttons on the front panel and keep them pressed
- turn on the sewing-/embroidery computer and release the buttons as soon as the Display appears



- touch «Display calibration»-icon

- touch the calibration icon



- touch the center of the cross using the touch pen
- ▶ the cross moves to the next position
- repeat this until all three positions shown are calibrated
- ▶ the Display is closed
- ▶ the calibration is saved

Altering the acoustic signals



- touch «Acoustic signal»-icon

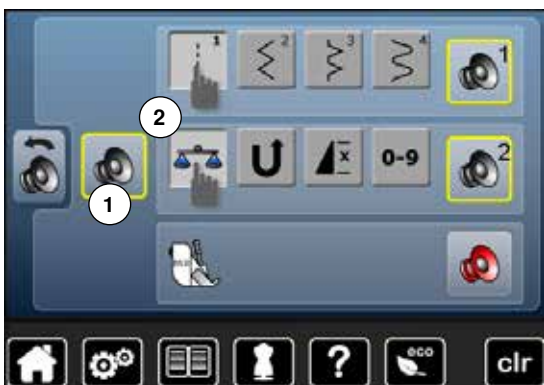

By touching **1** the signals are activated or deactivated.

Selecting Stitch Pattern/Function/BSR

Stitch patterns and function selection **2** can be confirmed acoustically.

- touch the icon with the loudspeakers for the stitch patterns until you hear the desired sound

There are six different sounds to choose from.

- ▶ the sound is indicated by a number (1-6)
- the sounds for the functions (center) and the sound for quilting with the BSR (below) can be activated or deactivated in the same way
- ▶ the deactivation is indicated as last option when scrolling through the different sounds

Monitoring



- touch «Monitoring»-icon



The following monitoring functions can be activated or deactivated:

- 1 Upper thread indicator
- 2 Lower thread indicator

Upper-/Lower thread indicator

- ▶ open eye = function active
- touch «Open eye»-icon
- ▶ closed eye = function inactive

The sound type for the monitoring functions is set in the audio settings for functions.

Altering the winding speed



- touch «Winding speed»-icon



- move round knob in the Display to the left/right or
- turn the stitch width knob
- ▶ the winding speed is changed

Update



Do not remove the BERNINA USB stick until there is a message which indicates the end of the update.



- insert BERNINA USB stick with the new software version
- touch «Update»-icon

It is recommended to save the data and the settings of the sewing computer before the update is carried out.

- touch icon 1
- the data of the sewing computer is saved on the USB stick
- touch «Update»-icon 2 to start the procedure

It is then checked if:

- ▶ a BERNINA USB stick is inserted
- ▶ there is enough free space available
- ▶ the correct software version is on the stick
- ▶ the data and settings are accepted

After the successful update a message appears and sewing-/embroidery computer is ready for use.

- ▶ if the update cannot be started or if there are problems during the update process, an error message appears

If the data and the settings aren't on the sewing computer anymore after the update:

- touch icon 3
- ▶ the data on the stick are saved on the sewing computer



Please find the latest version of Software at www.bernina.com

Calibrating buttonhole foot No. 3A



- touch «Calibration»-icon

- attach buttonhole foot No. 3A
- lower buttonhole foot No. 3A
- touch «Start/Stop»-button
- ▶ the buttonhole foot No. 3A moves forward and backwards
- ▶ the buttonhole foot No. 3A is calibrated and the sewing computer indicates whether the calibration has been successful

The buttonhole foot No. 3A is calibrated to this sewing computer and should only be used on this sewing computer.

Reset/Delete user data



- touch «Basic settings»-icon

Choose from following options:

- 1 Reset Settings
- 2 Delete user data

Reset settings

- touch icon 1

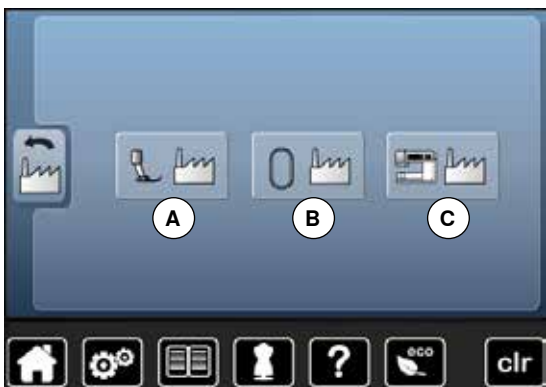

Choose from following options:

- A Reset Sewing
- B Reset Embroidery
- C Reset All

- touch the icon, whose settings should be reset to basic setting
- confirm with ✓
- ▶ the previous Display appears
- touch «Back»-icon
- ▶ selection menu appears

Exceptions:

Thread tension, brilliance, brightness, display color and speed need to be reset to basic state knowingly according to the corresponding function.

**Delete user data**

- touch icon 2



Choose from following options:

- D Sewing «Personal program»
- E Embroidery «My Designs»
- F Embroidery «Memory stick» (the Memory stick must be inserted in the sewing computer)

- touch the icon, whose data should be deleted
- confirm with ✓
- ▶ the data is deleted and the previous Display appears
- touch «Back»-icon
- ▶ selection menu appears

Information



- touch «i»-icon



Language

- scroll through the languages by touching the arrow icons and select the language required



- touch icon



Version

- ▶ the present version of the sewing computer and the attached embroidery module are visible
- ▶ the total number of stitches and the number of stitches sewn since the last servicing by the dealer are displayed



- touch icon



Dealer details

- touch respective icon
- Following details of the BERNINA-dealer can be registered:
- store name
 - address
 - telephone number
 - website or e-mail address



- touch icon



Service data

The service data of the present condition of the sewing-/embroidery computer can be saved on a memory stick and sent to the BERNINA-dealer:

- insert memory stick to sewing-/embroidery computer
- touch «LOG»-icon
- ▶ data is saved on the memory stick
- remove memory stick

Overview Tutorial

The tutorial provides information and explanations about the different areas of sewing and embroidering.

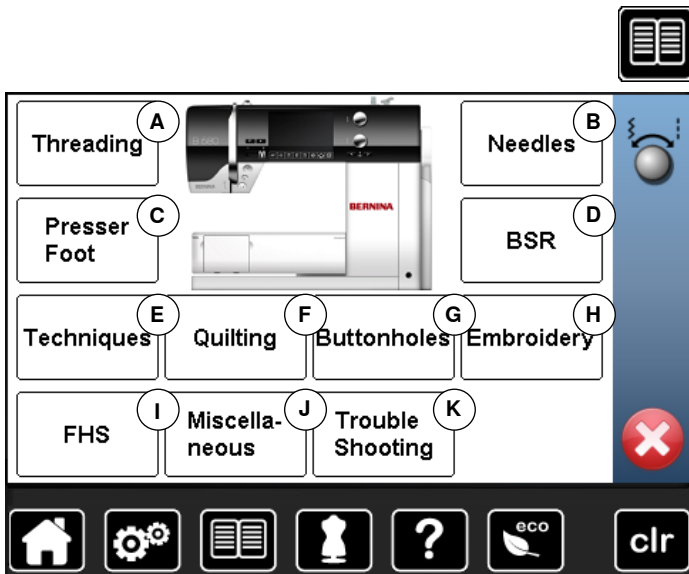

- touch «Tutorial»-button
- ▶ «Tutorial»-display appears

- A Threading
- B Needles
- C Presser foot
- D BSR
- E Sewing techniques
- F Quilting
- G Buttonholes
- H Embroidery
- I Free Hand System (FHS)
- J Miscellaneous
- K Troubleshooting

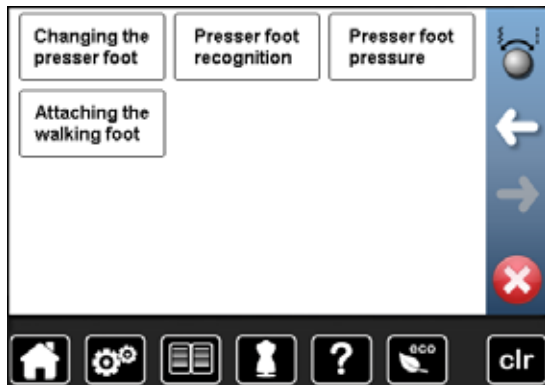

- select desired topic, e.g. presser foot
- ▶ topic overview about the presser foot appears
- select desired topic, e.g. changing the presser foot

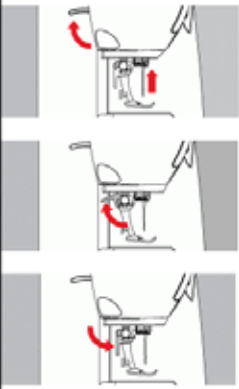

Changing the Presser Foot
 This is easily done using one hand.



Step 1:

- raise the needle and presser foot, power switch to «0» (off)
- raise the clamping lever and remove the foot
- to attach the presser foot, guide the foot onto the cone using your thumb and third finger and use your index finger to lower the clamping lever

End of Page

- ▶ information on the desired topic is shown
- scroll through the topics using the knobs, the finger or the touch pen



- touch «Next»
- ▶ the next page appears



- touch «Back»
- ▶ the previous page appears

- touch **X** and the «Tutorial»-display closes
- ▶ the previous Display appears

Overview Creative consultant

The creative consultant provides information and help with various sewing techniques. After selecting the fabric and the desired sewing technique suggestions for suitable needles, presser feet etc. are displayed.

▶ upper thread tension is automatically adjusted

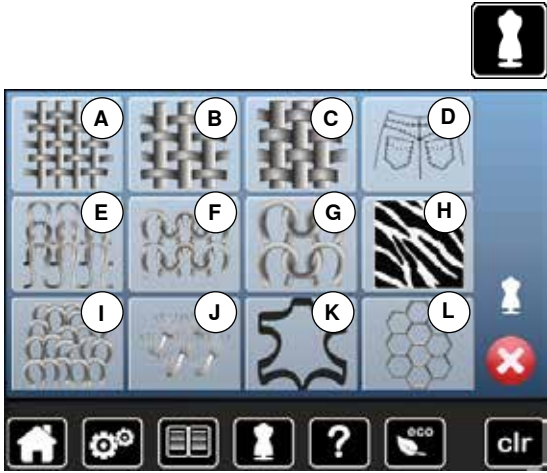

- touch «Creative consultant»-button
- ▶ «Creative consultant»-display appears

- A Light weight woven
- B Medium weight woven
- C Heavy weight woven
- D Jeans
- E Light weight knit
- F Medium weight knit
- G Heavy weight knit
- H Fur
- I Toweling
- J Fabric with a pile
- K Leather and Vinyl
- L Tulle and Laces

Overview Sewing techniques

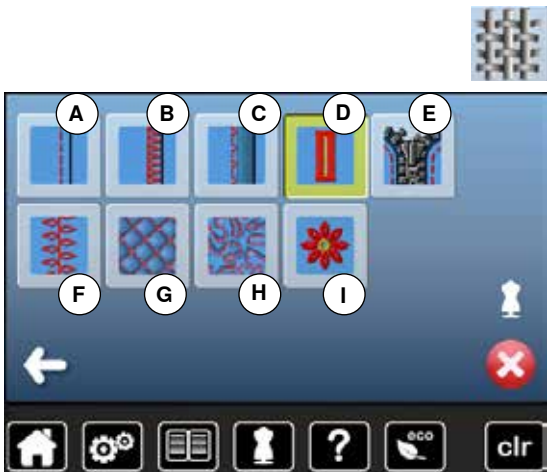

- touch icon of the desired material, e.g. light weight woven

The optional sewing techniques are displayed.

- A Seams
- B Overcasting
- C Blind hem
- D Buttonhole
- E Zipper
- F Decorative stitching
- G Machine quilting
- H Free-motion stitching
- I Appliqué



- select the desired sewing technique, e.g. buttonhole
- If the desired sewing technique is not in the list, choose a similar sewing technique.



- ▶ recommendations for the selected material and the desired sewing technique is displayed
- confirm with ✓
- ▶ display with the programmed stitch patterns appears

Leaving the sewing consultant

- touch ✗

Help program

The Help program provides information about individual stitch patterns and function icons in the Display.

Stitch patterns



- touch «Help program»-button
- select the desired stitch pattern or the desired function

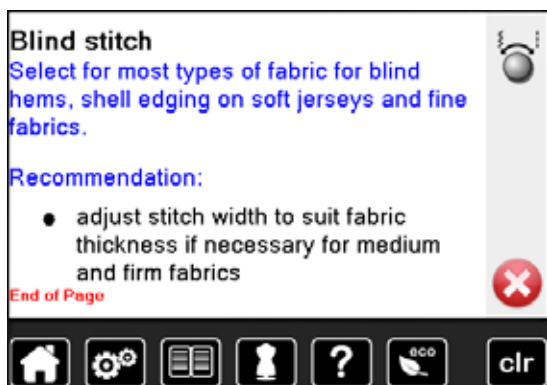

The Display shows the following information:

- ▶ stitch pattern name
- ▶ suitable materials
- ▶ recommendation

Functions

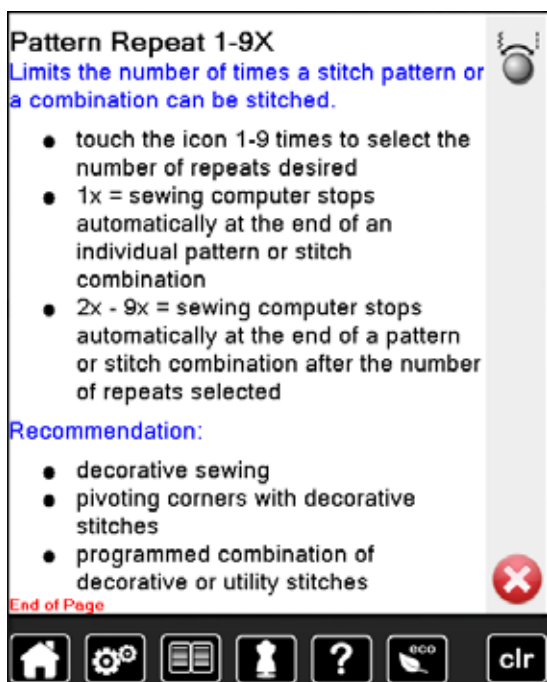

The Display shows the following information:

- ▶ function name
- ▶ function explanation
- ▶ recommendation

- touch **X**
- ▶ the Help program is closed
- ▶ the previous Display appears

Balance

The sewing computer is tested and optimally set before it leaves the BERNINA factory. Different fabrics, threads and stabilizers can affect programmed stitches so that they are not sewn out properly. These effects can be corrected with the electronic Balance so that the stitch formation can be adjusted where necessary to suit the material.

Practical and decorative stitches

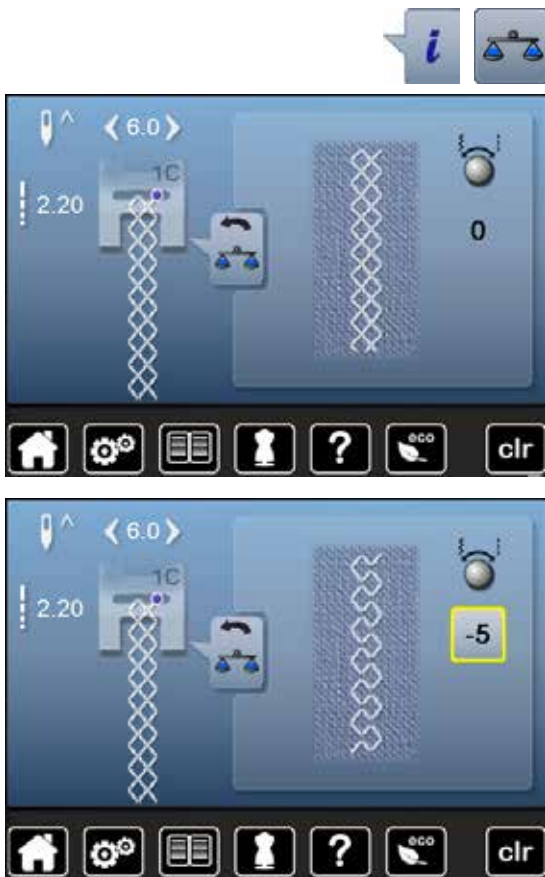

- touch «i»-icon
- touch «Balance»-icon

- ▶ in the left part of the Display the stitch pattern is shown as it is set originally (programmed)
- ▶ in the right part of the Display any alterations are directly visible

Corrections

The stitch sewn on the fabric (e.g. the Honeycomb stitch) opens up and it does not look correct:

- adjust the stitch length by turning the stitch width or stitch length knob, until the stitch in the right part of the Display is identical with the stitch on the fabric
- ▶ the alteration is shown with a number in the yellow-framed icon
- touch «Back»-icon 2x
- ▶ alterations are saved
- ▶ the previous Display appears

Reset settings

- touch «i»-icon
- touch yellow-framed «Balance»-icon
- touch yellow-framed icon
- ▶ basic setting is reset

eco description

When work is interrupted for longer periods, the sewing-/embroidery computer can be put into energy-saving mode.



- touch «eco»-button
- ▶ the Display gets dark
- ▶ power consumption is reduced and the sewing light turned off

The energy-saving mode also acts as a child safety feature. The Display is inactive and the sewing-/embroidery computer cannot be started.

- touch «eco»-button
- ▶ the sewing-/embroidery computer is ready for use

Overview Practical stitches

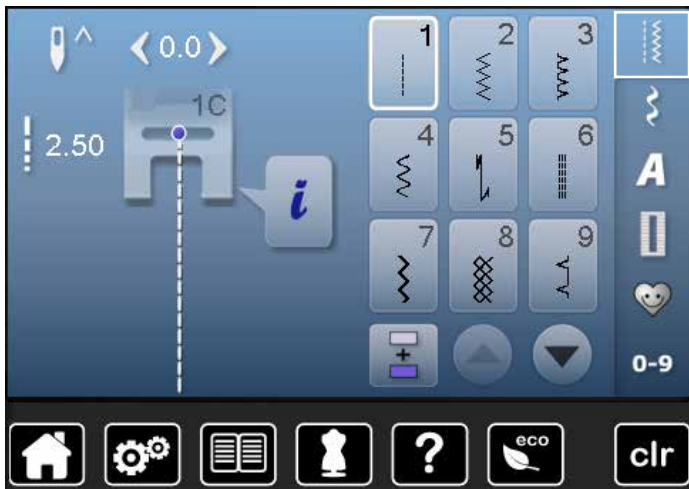

- touch «Practical stitch»-button
- ▶ the practical stitches are visible in the Display
- further practical stitches are visible by scrolling

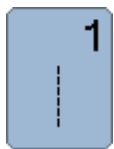

1 Straight stitch
For non-elastic materials; all straight stitch work, such as seams, topstitching, sewing zippers



2 Zig-zag
Zig-zag work such as overcasting edges, attaching elastic and lace



3 Vari-Overlock
For fine jerseys; stretch overlock seams, hems and stretch seams



4 Running stitch
Most types of fabric; Mending, patching, reinforcing seams, etc.

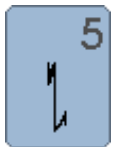

5 Securing program
For all materials; secures the beginning and end of seams by straight stitching

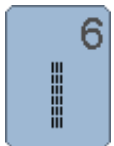

6 Triple straight stitch
Reinforced seams in heavy fabrics, visible hems and seams

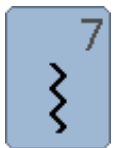

7 Triple zig-zag
Reinforced seams in heavy fabrics; visible hems and seams

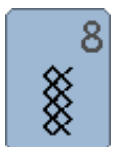

8 Honeycomb stitch
For all types of jersey and smooth materials; visible seams in lingerie, clothing, linen, mending etc.



9 Blind stitch
For most types of materials; Blind hems; shell edging effect on soft jerseys and fine material; decorative seams



10 Double-Overlock
For any knit materials; overlock seam = sewing and finishing in one step

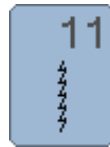

11 Super stretch stitch
For highly elastic fabrics; Highly elastic open seam for all types of clothing



12 Gathering stitch
Most types of fabric; Gathering with shirring elastic. Butted seams = butting two pressed edges and sewing together, decorative stitches



13 Stretch-Overlock
For medium weight knits, toweling and firm woven; Overlock seams, flat joining seams



14 Tricotstich
For jersey materials; visible hems, visible seams in lingerie, sweaters, mending jersey



15 Universal stitch
For firm fabrics such as felt and leather; flat joining seams, visible seams, attaching elastic, decorative seams



16 Sewn out zig-zag
Edge finishing and reinforcing, attaching elastic, decorative seam



17 Lycra stitch
All two-way stretch fabrics; flat joining seams and hems, reinforced seaming on underwear

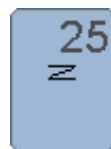

25 Bartack program
Reinforcing pocket openings, sewing on belt loops, securing zippers and seam ends



18 Stretch stitch
For highly elastic fabrics; open seam for sportswear



26 Large fly stitch
For medium weight to thick materials; reinforcing pocket openings, zippers and slits

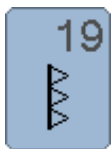

19 Reinforced Overlock
For medium-weight knitware and toweling; overlock seams, flat joining seams



29 Blindstitch narrow
For blind hems in fine materials

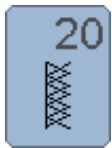

20 Knit Overlock
For knit material, hand- and machine made items; overlock seam = sewing and finishing in one step



31 Triple Straight Stitch with Long stitch
Reinforced seams in heavy fabrics, visible seams and topstitching

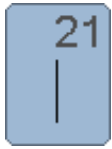

21 Basting stitch
Basting seams, hems, etc. temporarily



32 Single straight stitch
As a connecting stitch between two individual decorative stitch patterns in a combination



22 Simple darning program
Automatic darning of fine to medium weight materials



33 Three single straight stitches
As a connecting stitch between two individual decorative stitch patterns in a combination

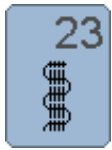

23 Reinforced darning program
Automatic darning of firm materials



34 Darning stitch
Use for darning in conjunction with the «Permanent Reverse» function

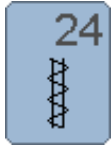

24 Bartack program
Reinforcing pocket openings, sewing belt loops etc.

Stitch pattern selection

Direct

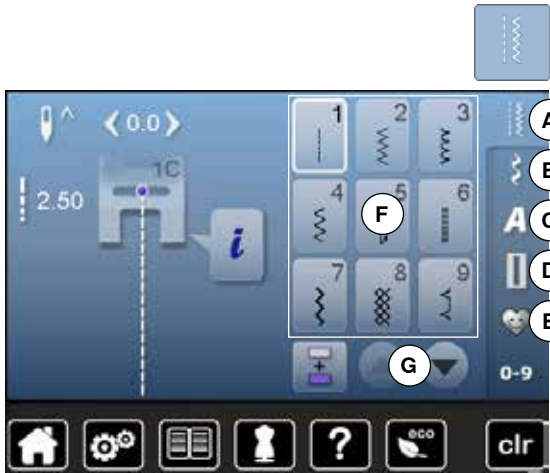

- select the desired main category **A-E**

- A** Practical stitches
- B** Decorative stitches
- C** Alphabets
- D** Buttonholes
- E** Personal program/Memory

- ▶ the available stitch patterns are visible in the Display portion **F**
- select desired stitch pattern
- further stitch patterns are visible when scrolling **G**

By stitch number

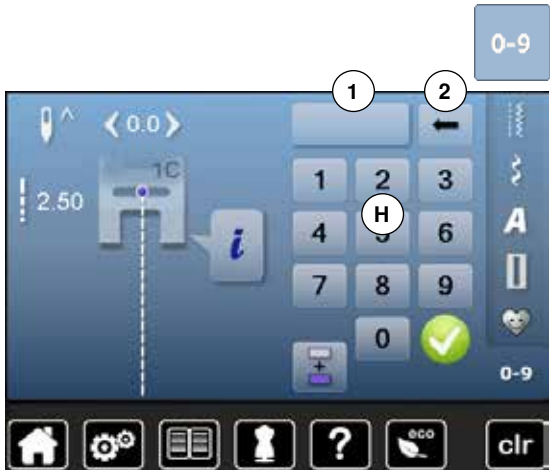

- touch «0-9»-button

- ▶ numbers for entering are visible in the Display portion **H**
- enter stitch number
- ▶ the entered stitch number **1** appears
- touch icon **2**
- ▶ last digit is deleted
- touch icon **1**
- ▶ complete number is deleted
- confirm with ✓

Cancelling

- touch «0-9»-button
- ▶ the previous Display appears



An invalid stitch number will be indicated in icon **1** with 3 question marks.

Customizing stitch pattern individually

According to material and purpose a stitch pattern can be altered individually. The alterations described here are applicable for all practical and many decorative stitches.



The personal memory is unlimited; it can hold as many stitch alterations as needed:

- Stitch length
- Stitch width
- Needle position
- Pattern Extend
- Mirror images
- Long Stitch function
- Thread tension
- Balance
- Pattern repeat 1-9x

Temporary altered stitch memory

Any altered stitch width and stitch length is automatically saved.

Example:

- sew with an altered stitch (e.g. zig-zag)
- select and sew another stitch, e.g. straight stitch
- return to zig-zag, your alterations are still active

Return to basic settings

Individual stitch patterns can be reverted to basic settings manually.

- touch stitch width/stitch length icon and in the respective Display the yellow-framed icon or
- press the «clr»-button
- ▶ any altered values of the **active** stitch return to basic setting
- switch off the sewing computer
- ▶ any alterations of all stitches are deleted



Altering stitch width and stitch length

- turn the knobs or
 - touch stitch width or stitch length Display
 - touch the arrow icons in the respective Display or
 - move the round knob in the Display using the touch pen or the finger
- Can be altered while sewing.



When sewing practical or quilting stitches the actual stitch length 1 is displayed.

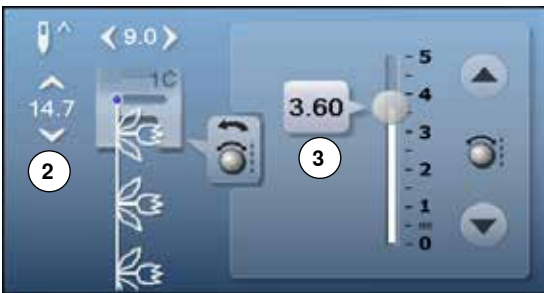

With other stitch patterns the overall length of a stitch pattern 2 is displayed. The actual stitch length 3 is visible when the stitch length Display is opened.



Altering needle position

- touch «Moving»-buttons for needle position or



- touch «i»-icon
- touch «Needle position»-icon

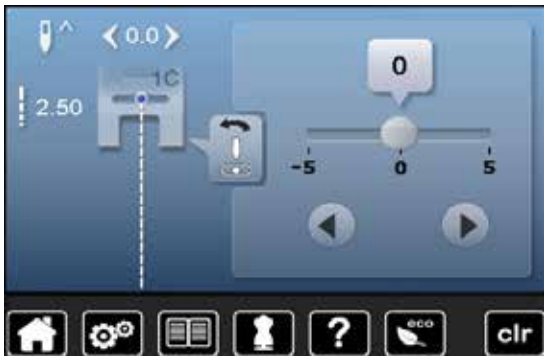

- keep «Moving»-buttons or arrow icons pressed
 - ▶ quick movement of the needle
 - move the bar in the Display using the touch pen or the finger
- 11 needle positions in total (5 left, 5 right, 1 center).

Examples of application

Straight stitch



Reverse pattern foot No. 1C

Straight stitch No. 1

After turning on the sewing computer the straight stitch will appear.

- ▶ the needle is up

Application

Suitable for all fabrics.



Adjust the stitch length to suit the fabric

E. g. use a longer stitch length (approximately 3-4mm) with denim, a shorter length with fine fabric (approx. 2-2.5mm).

Adjust the stitch length to suit the thread

E. g. use a longer stitch length thread when using cordonnnet thread for topstitching (approx. 3-5mm).

Activate needle stop down

Prevents the fabric from shifting when you adjust or pivot the sewing project.

Triple straight stitch



Reverse pattern foot No. 1C

Jeans foot No. 8

Triple straight stitch No. 6

Open seam

Durable seam for firm or dense materials such as denim and corduroy.



For firm or densely woven materials

A Jeans needle and Jeans foot No. 8 will help when sewing denim or canvas.

Decorative top stitch

Lengthen stitch and use the triple straight stitch for decorative topstitching.

Triple Zig-Zag



Reverse pattern foot No. 1C

Triple zig-zag No. 7

In firm materials, particularly for denim, deckchair covers, awnings.



Seams on often washed items. Finish raw edges first. Use Jeans needle for very firm materials.

Zipper

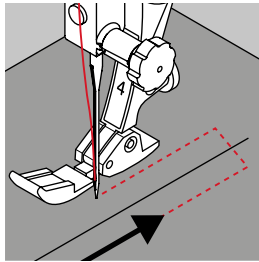

Zipper foot No. 4

Straight stitch No. 1

Preparation

- close seam to the zipper beginning
- sew securing stitches
- baste seam closed and clean
- finish the seam allowance
- iron the seam
- open the zipper
- baste the zipper: baste or pin zipper in place so that fabric folded edges meet over the center of the zipper

Sewing in the zipper

- open zipper a little
- move needle position to the right
- start sewing from top left
- position the foot so the needle stitches along the edge of the zipper coils
- stop in front of the pull (needle position down)
- raise the presser foot
- close the zipper again
- lower the presser foot
- continue to sew, stop in front of the base of the zipper, needle position down
- raise the presser foot
- turn the sewing project
- lower the presser foot
- sew across the seam, stop with needle position down
- raise the presser foot
- turn sewing project again
- lower the presser foot
- sew the second side from bottom to top

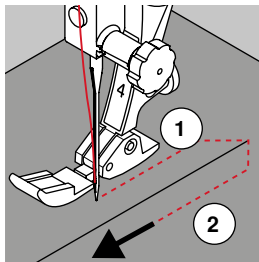

Variation: Sew both sides of zipper from bottom to top

Suitable for all fabrics with nap or grain (e.g. velvet).

- prepare zipper as described above
- start sewing in the seam of the zipper end and sew first side from bottom to top
- sew diagonal along the edge of the zipper coils
- first side 1 sew from bottom to top
- move needle position to the left
- second side 2 sew in the same way from bottom to top



Sew around the zipper pull

- sew up to about 5cm away from the zipper pull
- stop with the needle down, raise the presser foot, open the zipper, lower the presser foot, finish sewing (use Free Hand System)

Seam begin

- hold thread firmly when starting to sew = pull fabric slightly to the back (fewer stitches) or
- sew about 1-2cm reverse first, and continue to sew as usual

Zipper or fabric is thick or densely woven

For even stitch formation use a 90-100 needle.

Manual darning

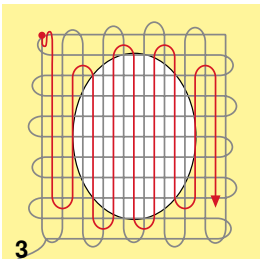
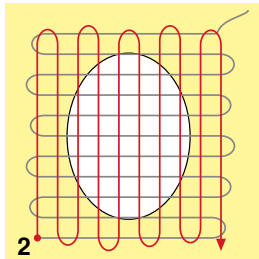
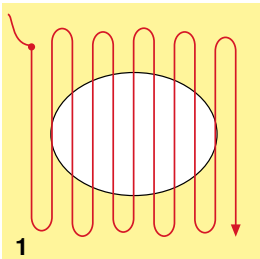
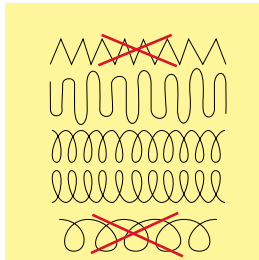

Darning foot No. 9 (optional accessory)

Straight stitch No. 1

Holes or worn areas

«Replacing» threads along the lengthside and crosswise in every material.

Preparation

- lower the feed dog
- attach the Slide-on table
- hoop the fabric into the darning hoop (optional accessory)
- ▶ the darning area stays evenly taut and cannot be distorted

Sewing

- work from the left to the right, guide the fabric evenly without using pressure
- move in curves when changing direction on top and on bottom. Avoid points as this can cause holes and thread breakage
- sew different length. The thread is better spread over the fabric

1 Sew the first rows to cover the hole

- first rows just beyond the worn area and not too close together
- work the rows in irregular lengths
- turn work by a quarter turn -90°

2 Sew over the first rows

- first rows not too close
- turn fabric by half turn -180°

3 Finish darning the hole

- sew another loose row



Poor stitch formation

- if the thread is lying on top, slow down the fabric movement
- if there are knots on the wrong side of the fabric, move the fabric more quickly

Thread breaks

Guide the fabric more consistently.

Automatic darning



Reverse pattern foot No. 1C
Buttonhole foot No. 3A

Simple darning program No. 22

Quick darning of holes or worn areas

Replaces threads along the lengthwise grain in all materials.

Preparation

- hoop light weight materials in the darning hoop (optional accessory)
- ▶ the darning area stays evenly taut and cannot be distorted

Darning with reverse pattern foot No. 1C

- insert the needle in the top left of the worn area
- sew first row
- stop sewing computer
- press «Quick reverse»-button
- ▶ the length is programmed
- finish sewing the darning program
- ▶ the sewing computer stops automatically
- press the «clr»-button
- ▶ the program is cleared

Darning with the buttonhole foot No. 3A

- for darning worn and damaged areas
- darning length max. 3cm
- same procedure as with Reverse pattern foot No. 1C



Reinforcement

Use fine material or (adhesive) interlining as a backing.

If the darning becomes distorted

Correct with the Balance function (more about Balance-Function see page 54).

Reinforced darning, automatic



Buttonhole foot No. 3A

Reinforced darning program No. 23

Quick darning of holes or worn areas

Replaces threads along the lengthwise grain in all materials.

Preparation

- hoop light weight materials in the darning hoop (optional accessory)
- ▶ the darning area stays evenly taut and cannot be distorted

Darning with the buttonhole foot No. 3A

Insert the needle in the top left of the worn area.

- sew first row
- press «Quick reverse»-button
- ▶ the length is programmed
- finish sewing the darning program
- ▶ the sewing computer stops automatically
- press the «clr»-button
- ▶ the programmed settings are cleared



If the darning does not cover the whole worn or damaged area

Reposition the work under the foot to continue covering the worn or damaged area. Begin sewing; the program will repeat as often as desired (the length is saved).



Per «Direct entry length» (see page 32) a darning length up to 30mm can be programmed.

Finishing edges



Reverse pattern foot No. 1C

Zig-zag No. 2

- for all fabrics
- for finishing raw edges
- elastic seams
- decorative sewing

Finishing edges

- guide edge of fabric into the center of the presser foot
- do not select too wide a stitch
- do not select too long a stitch
- needle goes into fabric on one side and over the edge into the air on the other side
- the edge of the fabric should lie flat and not roll
- use darning thread for fine materials

Satin stitch

- dense, short zig-zag (stitch length 0.5-0.7mm)
- use satin stitch for appliqué, embroidery, etc



As a variation the satin stitch No. 1354 can be used.

Double-Overlock

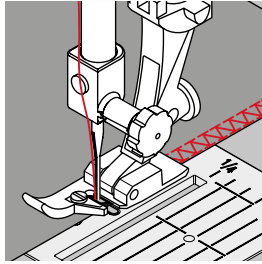
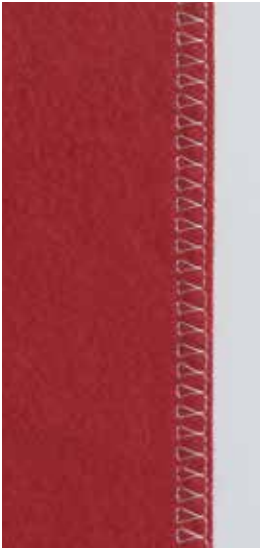

Overlock foot No. 2A
Reverse pattern foot No. 1C

Double overlock No. 10

Closed seam

Double overlock seam in loose knits and cross seams in knits and jerseys.

Sewing

- guide the pin of the Overlock foot along the cut edge



Knits and jersey

- use a new Jersey needle to prevent damaging the loops
- if necessary loosen presser foot pressure

Sewing stretch materials

If necessary use a stretch needle (130/705H-S).

Top stitching edges

Blindstitch foot No. 5
Reverse pattern foot No. 1C
Edge stitch foot No. 10 (optional accessory)

Straight stitch No. 1

Narrow edgestitching

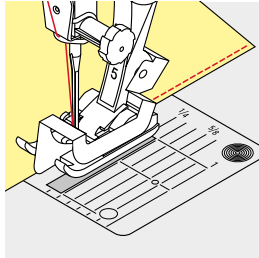

Outer edges

- place edge of fold left against the guide on the blindstitch foot
- select the needle position left in the desired distance to the edge

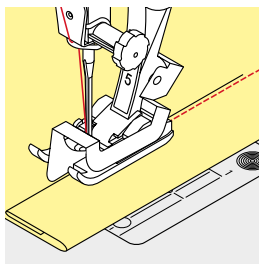

Hem edges

- place edge of fold (inside upper edge of hem) right against the guide on the blindstitch foot
- select needle position to the right to sew along the upper edge



Blindstitch foot No. 5
 Needle position left or far right.

Reverse pattern foot No. 1C and edge stitch foot No. 10 (optional accessory)
 Any needle position possible.

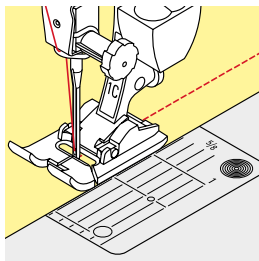

Wide edgestitching

Material guidance

Presser foot as guide:

- guide the folded edge along the edge of the presser foot

Stitch plate as guide:

- guide the folded edge along the marks on the stitch plate (1 to 2.5cm)

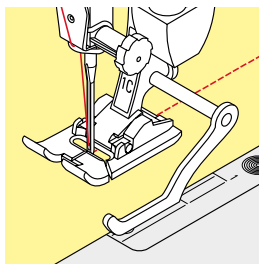

Seam guide as guide:

Presser foot

- loosen the screw on the back of the presser foot
- insert the seam guide into the hole of the presser foot
- adjust width as desired
- tighten the screw
- guide the folded edge along the seam guide

To sew parallel wider lines, guide the seam guide along a previously sewn line of stitches.

Blind hem

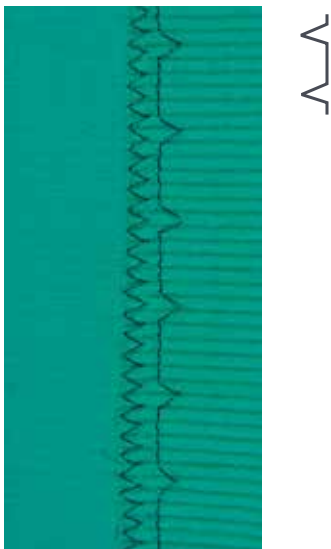

Blindstitch foot No. 5

Blindstitch No. 9

For invisible hems in medium to heavy weight cotton, wool and blended materials.

Preparation

- finish the raw edges
- fold the hem and baste or pin in place

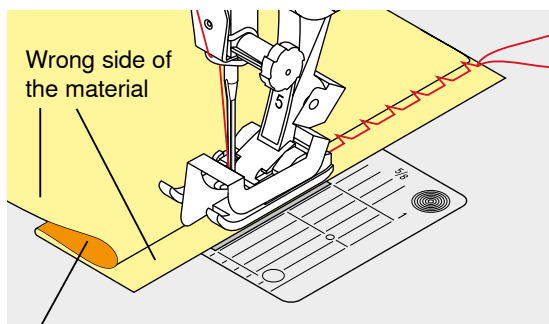

Right side of the material

- fold the fabric back over the right side of the fabric to expose the finished lower edge
- place under presser foot and
- move the folded edge against the metal guide on the presser foot

Sewing

The needle should just pierce the edge of the fold, as when hand blind-stitching.

- after sewing about 10cm, check both sides of fabric and adjust width again if necessary



Fine stitch width adjustment

Guide the folded edge evenly along the metal guide on the foot = even depth.

Visible hem



Reverse pattern foot No. 1C

Tricot stitch No. 14

For visible, elastic hems in jersey, cotton, synthetic and mixed fibers.

Preparation

- iron the hem, baste if necessary
- reduce the presser foot pressure if necessary

Sewing

- sew the hem at preferred depth on the right side
- trim excess fabric from the wrong side

Securing program



Reverse pattern foot No. 1C

Securing program No. 5

- for all fabrics
- secures beginning and end of seam

Sewing long seams with straight stitch

Even securing by defined stitch count.

Beginning to sew

- press the foot control
- ▶ the sewing computer secures automatically when beginning to sew (5 stitches forward, 5 stitches in reverse)
- sew seam with straight stitches in desired length



Ending the seam

- press «Quick reverse»-button
- ▶ the sewing computer secures seam automatically (5 stitches in reverse, 5 stitches forward)
- ▶ the sewing computer stops automatically at the end of the securing program

Basting stitch



Reverse pattern foot No. 1C

Basting stitch No. 21

- straight stitch, sews out every fourth stitch, i.e. longest stitch possible is 20mm, when the stitch length is set at 5mm. Recommended stitch length 3.5-5mm
- for work which requires a very long stitch
- basting seams, hems, Quilts etc.
- temporary joining
- easy to remove

Preparation

- pin work at a right angle to basting direction
- ▶ to prevent the layers from slipping



Securing/fixing the thread

Sew 3-4 securing stitches at the begin and at the end.

Thread

Use a fine darning thread for basting as it is easier to remove.

Flat joining seam

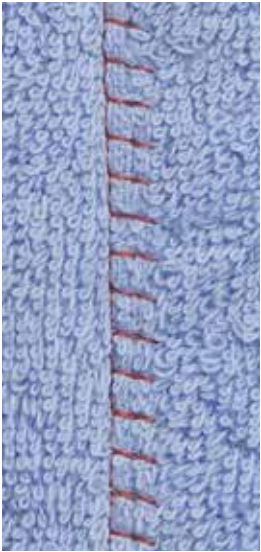

Reverse pattern foot No. 1C

Stretch-overlock No. 13

Ideal for fluffy or thick materials such as terry cloth, felt and leather etc.

Sewing

- overlap fabric edges
- sew along the fabric edge
- the stitch should sew over the edge of the top layer on the right side
- ▶ very flat durable seam

Height compensation of uneven layers

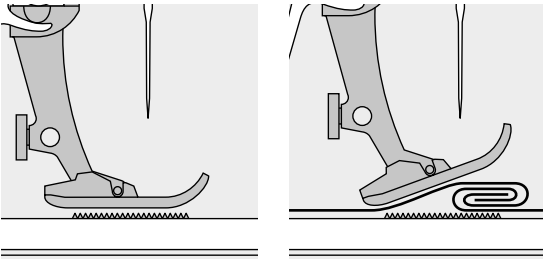

The feed dog works accurately when the foot is level.

If the foot is at an angle, e.g. when sewing over thick to thin or vice-versa, the feed dog cannot grip and feed the fabric. The fabric might jam.

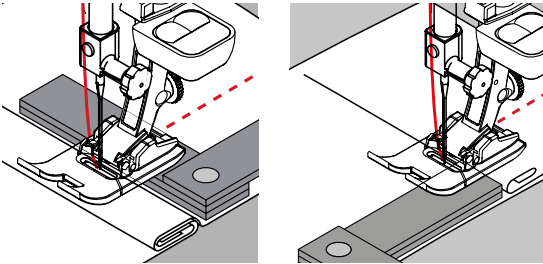

To solve this problem, place one, two or three compensating plates as required behind the needle under the presser foot to level it.

To correct the height in front of the foot, place one or more plates under the foot close to the needle. Sew until the foot is level again and remove the plates.



Needle stop down.

Sewing corners

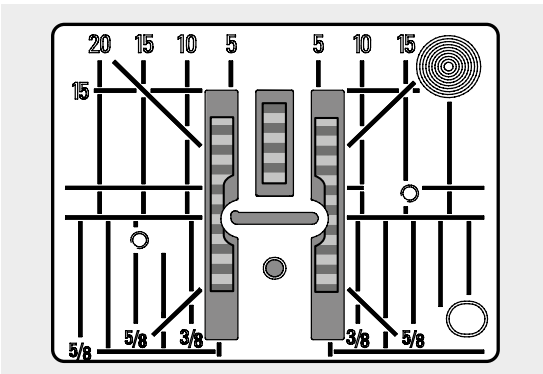

Due to the width of the stitch plate hole the outer feed dog rows are relatively far apart.

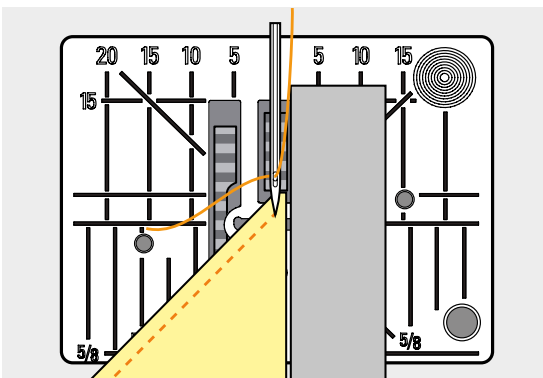

When sewing corners only a small section of the fabric is actually on the feed dog. Therefore it cannot grip the fabric well.

Place one or more plates of the height compensation tool parallel to the presser foot close to the edge of the fabric.

▶ the fabric is fed evenly



Needle stop down.

Overview Buttonhole

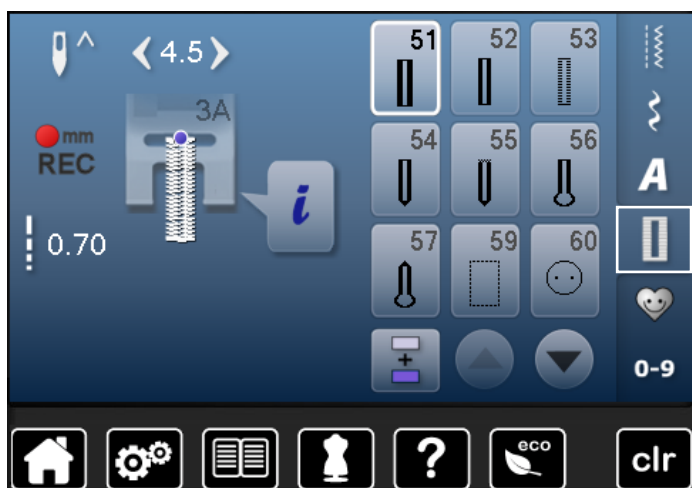

Buttonholes are not only practical closures, they can also be used as a decorative effect. All buttonholes can be programmed and sewn in different ways.

- touch «Buttonhole»-button
- scroll to see more buttonholes



51 Standard buttonhole
For light to medium weight fabrics; blouses, shirts, trousers, bedlinens, etc.

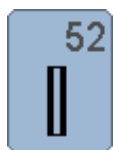

52 Narrow buttonhole
For light- to medium weight fabrics; blouses, dresses, children's and baby clothes, crafts

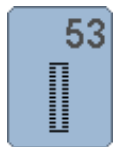

53 Stretch buttonhole
For any highly elastic jersey made from cotton, wool, silk and synthetic fibers

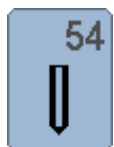

54 Round buttonhole with normal bartack
For medium- to heavy weight materials: dresses, jackets, coats, rainwear

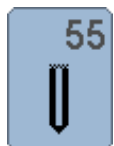

55 Round Buttonhole with horizontal bartack
For medium- to heavy weight fabrics of all types: dresses, jackets, coats, rainwear

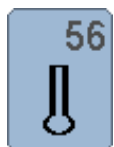

56 Keyhole buttonhole
For heavy weight, non-stretch materials; jackets, coats, leisure wear

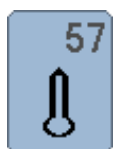

57 Keyhole Buttonhole with Pointed Bartack
For firmer, non-stretch fabrics: jackets, coats, leisure wear

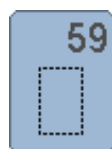

59 Straight-stitch buttonhole
Program for staystitching buttonholes, for pocket openings, reinforcing buttonholes; especially for buttonholes in leather and imitation leather



60 Button sew-on program
For buttons with 2 and 4 holes.



61 Eyelet with small zig-zag
Openings for cords and narrow ribbons, decorative work



62 Straight-stitch eyelet
Openings for cords and narrow ribbons, decorative work

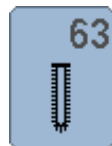

63 Heirloom buttonhole
For light- to medium weight woven fabrics; blouses, dresses, leisure wear, bed linen

Buttonhole - Important information

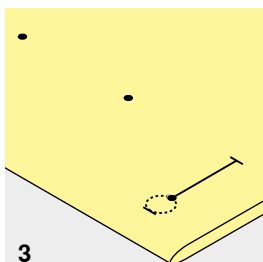
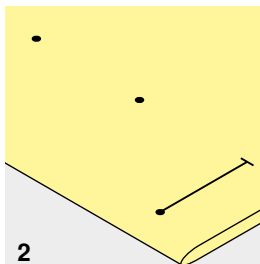
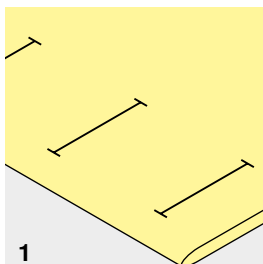

1 Marking the length of manual buttonholes

- mark the buttonhole length in the desired position
- use buttonhole foot No. 3C (optional accessory)

2 Marking the length of automatic buttonholes

- mark the length of just one buttonhole
- ▶ after sewing the first buttonhole the length is programmed
- mark only the beginning of all subsequent buttonholes
- use automatic buttonhole foot No. 3A

3 Marking the length of keyhole buttonholes

- mark the bead length only
- ▶ the correct length eye will be added when the buttonhole is sewn
- ▶ after sewing the first buttonhole the length is programmed
- mark only the beginning of all subsequent buttonholes
- use automatic buttonhole foot No. 3A

Test sewing

- always sew a test sample of the same fabric and
- with stabilizer you intend to use
- select the buttonhole type you intend to use
- sew the buttonhole in the same direction on the fabric (horizontal or vertical, with or against the grain)
- cut the buttonhole open
- push the button through the buttonhole
- adjust the buttonhole length if necessary

To adjust the bead width

- alter the stitch width

To adjust stitch length

Stitch length adjustments affect both buttonhole beads.

- ▶ spacing between the stitches

After stitch length adjustment:

- re-program the buttonhole



If a buttonhole is to be sewn at right angles to the seam, we recommend the use of the height compensation plates (optional accessory). Place the plates from the back between fabric and bottom of slide foot up to the thick part of the fabric and push to front.

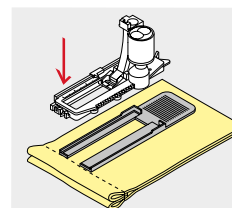

When sewing a buttonhole in difficult materials, we recommend using the Compensation plate for buttonholes (optional accessory). It can be used along with buttonhole foot No. 3A.

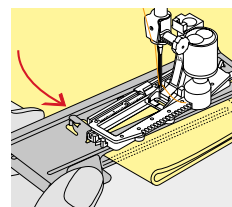

Stabilizer



- interfacing provides durability and stability to the buttonhole
- choose the interfacing according to the material being used

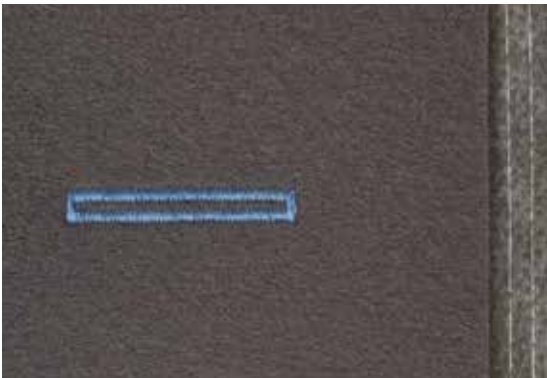

- when using thick or fluffy materials an embroidery stabilizer can be used
- ▶ therefore the fabric feeds better

Cords

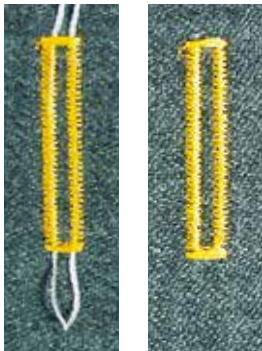

Generally

- cords reinforce buttonholes and enhance their appearance
- the loop of the cord should be at the end of the buttonhole that is most subject to wear = where button is sewn on
- position the work accordingly

Ideal cords

- Perle cotton No. 8
- strong hand-sewing thread
- fine crochet yarn

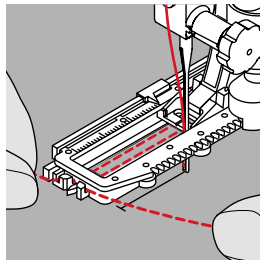
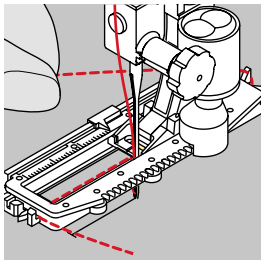

Cord with the automatic buttonhole foot No. 3A

- raise the buttonhole foot No. 3A
- insert the needle at the beginning of the buttonhole
- guide the cord on the right side under the buttonhole foot No. 3A
- hook the cord over the pin at the back of the buttonhole foot No. 3A
- pull the cord on the left side under the buttonhole foot No. 3A to the front
- pull the cord ends into the slits
- lower the buttonhole foot No. 3A

Sewing

- sew the buttonhole in the usual manner
- do **not** hold the cord
- ▶ the buttonhole will sew over the cord, covering it

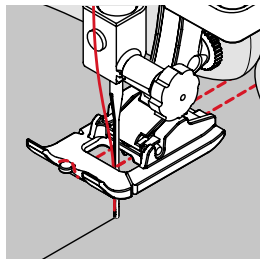
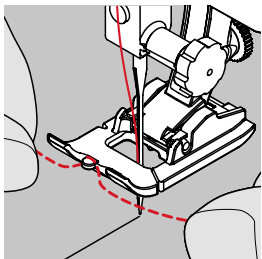

Cord with the buttonhole foot No. 3C (optional accessory)

- raise the buttonhole foot
- insert the needle at the beginning of the buttonhole
- hook cord over the pin in the middle of the buttonhole foot (at the front)
- pull both cord ends under the buttonhole foot sole to the back and
- place both ends of the cord in the grooves on the sole
- lower the buttonhole foot

Sewing

- sew the buttonhole in the usual manner
- do **not** hold the cord
- ▶ the buttonhole will sew over the cord, covering it

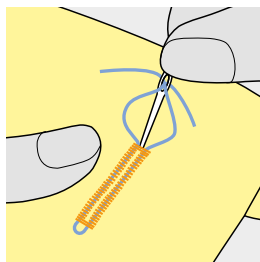

Fixing the cord

- pull the cord through the buttonhole until the loop disappears into the end of it
- pull the ends of the cord through to wrong side of the fabric, using a hand stitching-needle
- knot or secure with stitches



Before cutting the buttonhole open

Place a pin in each end of the buttonhole to prevent accidental cutting into ends of buttonhole.

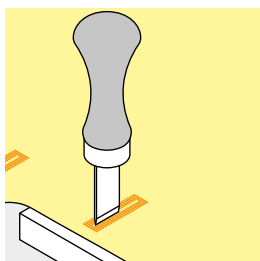
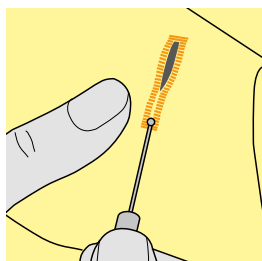

Cutting buttonholes open with the seam ripper

- cut the buttonhole from the ends to the middle

Cutting open buttonholes with the buttonhole cutter (optional accessory)

- place the fabric on the wood
- place the cutter in the centre of the buttonhole
- press down on the cutter with your hand

Altering the balance



- touch «i»-icon
- touch «Balance»-icon

Balance with direct entry length buttonholes

The balance alterations have the same effect on both beads.

Balance with direct entry length keyhole or round buttonholes

The balance alterations have the same effect on both beads.

The keyhole or eye is balanced as follows:

- sew straight stitches forward until
 - ▶ the sewing computer changes to the keyhole or eye, then
- stop the sewing computer
- touch the «Balance»-icon
- turn the stitch length-knob until the picture in the right portion of the Display is identical with the sewn buttonhole

The keyhole is distorted to the right **A**:

- turn stitch length knob to the left

The keyhole is distorted to the left **B**:

- turn the stitch length-knob to the right
- touch «Back»-icon and complete the buttonhole

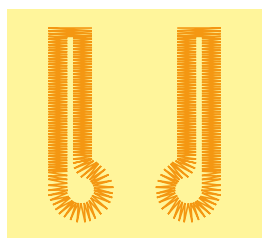

A

B

Balance for manual keyhole or round buttonhole

Any balance alteration affects both beads differently:

Left bead too dense **C**:

- turn the stitch length-knob to the left
 - ▶ the left bead is elongated, the right bead is shortened

Left bead too wide **D**:

- turn stitch length-knob to the right
 - ▶ the left bead is shortened, the right bead is elongated

The keyhole or eye is balanced as follows:

The keyhole is distorted to the right **A**:

- turn the stitch length knob to the right

The keyhole is distorted to the left **B**:

- turn the stitch length knob to the left

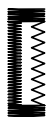

C

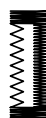

D

Balance for manual standard buttonhole

The balance alterations have the same effect on both beads.

Balance for stitch counter buttonhole

The balance has a different effect on both beads (see picture of the manual buttonhole).

- re-program the buttonhole after each alteration in balance

Clear balance

- touch the yellow-framed icon in the special Balance-display or
- press the «clr»-button
 - ▶ «clr» also deletes the programmed buttonhole!

Recommendation

Test-sewing of the buttonhole on the original material.



In all Direct entry length and manual buttonholes each individual buttonhole sequence can be balanced separately. In stitch counter buttonholes the balance affects both beads differently (left and right): When altering the bead the keyhole or eye are automatically altered accordingly.

Programming

Standard and stretch buttonhole with auto-length, automatically



Buttonhole foot No. 3A

Automatic standard and stretch buttonhole No. 51, 52, 53

The lens on the automatic buttonhole foot No. 3A automatically registers the length of the buttonhole for exact duplication. For buttonholes of 4-31mm, depending on the buttonhole type.



The slide foot must lie perfectly flat on the fabric! If the slide foot rests on a seam allowance, the length cannot be measured accurately.

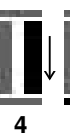
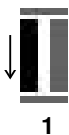

Programming the buttonhole

- 1 ■ sew first bead forward
- stop the sewing computer
- press the «Quick reverse»-button
- ▶ «auto» and the programmed length (in mm) appears in the Display
- ▶ the buttonhole length is programmed

The sewing computer sews automatically:

- 2 the straight stitches in reverse
- 3 the first bartack
- 4 the second bead forwards
- 5 the second bartack and securing stitches
- ▶ the sewing computer stops and returns automatically to buttonhole begin

Auto buttonhole

- ▶ all subsequent buttonholes will be sewn to exactly the same length (no need to press the «Quick reverse»-button)
- the programmed buttonholes can be saved in the long-term memory (see page 83)
- press the «clr»-button
- ▶ the programmed settings are cleared



Exact duplication

The auto function ensures that each buttonhole will be exactly the same length as the previous one.

Sewing speed

- sew at moderate speed for best results
- sew all buttonholes at the same speed for a consistent bead density

Automatic with direct length entry

Buttonhole foot No. 3A

Programming the buttonhole length

Buttonholes can be sewn to a specific length with the buttonhole foot No. 3A. Buttonhole length = cutting length in mm.



- select the desired buttonhole
- touch «i»-icon
- touch «Direct entry length»-icon

Determining buttonhole length

- enter the buttonhole length using the multifunction knobs (stitch width or stitch length knob)
 - ▶ the length entered appears on the left of the button
 - ▶ the number on the right of the button is the exact button size
- touch «Back»-icon
 - ▶ the length entered is saved
 - ▶ the programmed length is displayed on the left

Back to the buttonhole menu

- touch «Back»-icon
 - ▶ the Buttonhole Display appears

Automatic with button measuring

Buttonhole foot No. 3A

Determining button size

The sewing computer calculates the length of the buttonhole directly from the diameter of the button. 2mm are automatically entered for the button thickness.

- hold the button on the bright field in the lower right corner of the Display
- adjust the bright field to the button size using the stitch width or stitch length knob
 - ▶ the button size is displayed in mm on the right of the button between the arrows (e.g. 14mm)
- remove the button from the Display
- touch «Back»-icon
 - ▶ the length entered is saved
 - ▶ the programmed length is shown on the left side of the Display

Corrections for thick buttons

Match buttonhole length to buttonhole thickness (raised buttons, etc.) e.g. buttonhole length + 1cm (incl. 2mm) if button height is 1cm. The button slides easily through the buttonhole.



Back to buttonhole begin

- touch «Pattern begin»-icon
 - ▶ the sewing computer sets the program to the start of the buttonhole again



Deleting saved buttonholes

- press the «clr» button or touch «recording»
 - ▶ «auto» goes off and «REC» appears
- a new buttonhole length can be programmed

Automatic round and keyhole buttonhole



Buttonhole foot No. 3A

Automatic round and keyhole buttonhole No. 54, 56, 57



The slide foot must lie perfectly flat on the fabric! If the slide foot rests on a seam allowance, the length cannot be measured accurately.

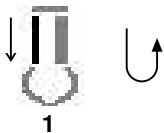

Programming buttonholes

- 1 ■ sew straight stitches forward
- stop the sewing computer
- press «Quick reverse»-button
- ▶ «auto» and the programmed length (in mm) appears in the Display
- ▶ the buttonhole length is programmed

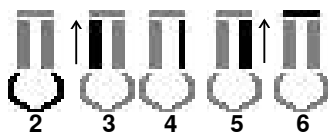

The sewing computer sews the following automatically:

- 2 the eye
- 3 the first bead in reverse
- 4 the straight stitches forward
- 5 the second bead in reverse
- 6 the bartack and securing stitches
- ▶ the sewing computer stops and returns automatically to buttonhole begin

Auto-buttonhole

- ▶ all subsequent buttonholes will be sewn to exactly the same length (no need to press the «Quick reverse»-button)
- the programmed buttonholes can be saved in the long-term memory (see page 83)
- press «clr»-button
- ▶ the programmed settings are cleared



Exact duplication

The auto function ensures that each buttonhole will be exactly the same length as the previous one.

Double sewn keyhole buttonholes

- keyhole buttonholes can be sewn twice on thick fabrics - use a longer stitch length for the first run
- after sewing the first buttonhole, do not move the work
- reduce the stitch length manually and sew the buttonhole again

Heirloom Buttonhole

Buttonhole foot No. 3A

Heirloom buttonhole No. 63

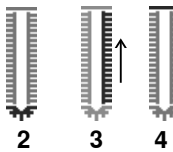
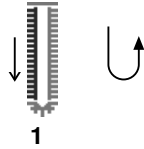

Programming the buttonhole

- 1 ■ sew first bead forward
- stop the sewing computer
- press «Quick reverse»-button
- ▶ «auto» and the programmed length (in mm) appears in the Display
- ▶ the buttonhole length is programmed

The sewing computer sews the following automatically:

- 2 the round part
- 3 the second bead in reverse
- 4 the bartack and the securing stitches
- ▶ the sewing computer stops and returns automatically to buttonhole begin

Auto buttonhole

- ▶ all subsequent buttonholes will be sewn to exactly the same length (no need to press the «Quick reverse»-button)
- the programmed buttonholes can be saved in the long-term memory (see page 83)
- press «clr»-button
- ▶ the programmed settings are cleared

Stitch counter buttonhole



Buttonhole foot No. 3C

All buttonhole types

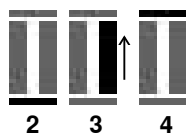
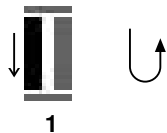

Programming the buttonhole

- 1 ■ sew first bead forward
 - stop the sewing computer
 - press «Quick reverse»-button
- 2 sew lower bartack and
 - 3 sew second bead in reverse
 - stop the sewing at the first stitch
 - press «Quick reverse»-button
 - 4 the sewing computer sews the upper bartack, the securing stitches and stops automatically
 - ▶ «auto» appear in the Display
 - ▶ the buttonhole length is programmed
 - ▶ each subsequent buttonhole will be sewn identically



– the first bead (left) is sewn forwards, the second bead (right) is sewn in reverse

Buttonhole in long term memory



- touch «Memory»-button



Programming the buttonhole

- touch «Save»-icon 1
- the «Save»-display appears
- touch «Save»-icon
- ▶ the buttonhole is now saved in long term memory



- touch «Memory»-button

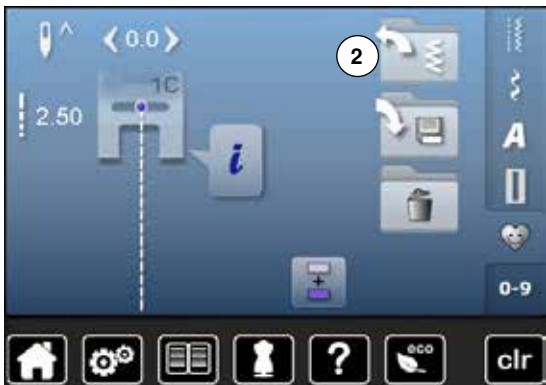

Selecting a saved buttonhole

- touch folder 2



- select buttonhole



Altering saved buttonhole

- touch «i»-icon
- touch «Direct entry length»-icon
- alter the length of the saved buttonhole
- touch «Back»-icon twice
- reprogram the buttonhole as described



- touch «Memory»-button

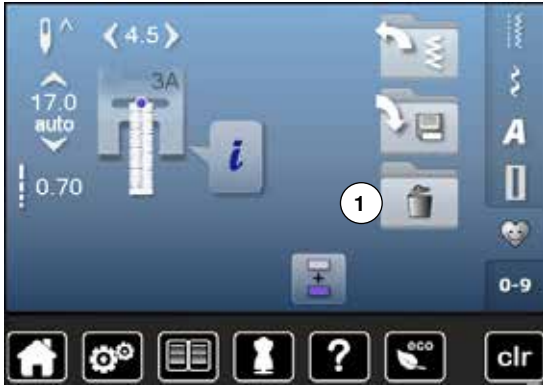

Deleting a saved buttonhole

- touch «Delete»-icon 1
- ▶ the saved buttonholes appear
- select desired buttonhole
- confirm with ✓
- ▶ the buttonhole is deleted

7- or 5-steps-buttonhole, manually



- select the desired buttonhole
- touch «i»-icon
- touch «man»-icon

The length of the beads is manually determined when sewing. Bartack, eye and securing stitches are pre-programmed. The individual steps can also be selected by scrolling, by using the arrow icons or by touching the «Quick reverse»-button.



Sewing 7-Step buttonhole

- ▶ step 1 is activated for buttonhole begin
- ▶ step 2 is activated when beginning to sew
- sew first bead
- stop the sewing computer at desired length of the bead or to the end of the length marking
- select step 3
- ▶ sewing computer sews straight stitches in reverse
- stop sewing computer at the height of the first stitch (buttonhole begin)
- select step 4
- ▶ the sewing computer sews top bartack and stops automatically
- select step 5
- ▶ the sewing computer sews the second bead
- stop the sewing computer at the height of the first bead
- select step 6
- ▶ the sewing computer sews bottom bartack and stops automatically
- select step 7
- ▶ sewing computer secures stitches and stops automatically



Sewing 5-Step buttonhole

- ▶ step 1 is activated for buttonhole begin
- ▶ step 2 is activated when beginning to sew
- sew first bead
- stop the sewing computer at desired length of the bead or at the end of the length marking
- select step 3
- ▶ the sewing computer sews the eye or the keyhole and stops automatically
- select step 4
- ▶ the sewing computer sews the second bead in reverse
- stop the sewing computer at the height of the first stitch (buttonhole begin)
- select step 5
- ▶ sewing computer sews the top bartack and secures stitches automatically



Straight stitch buttonhole No. 59

- The same programming procedure as with the auto buttonhole program (see page 79)
- Staystitching buttonholes with the straight stitch buttonhole No. 59 is recommended for soft, loosely woven fabrics and for buttonholes that will receive excessive wear. Staystitching also reinforces buttonholes in leather, vinyl and felt

Button sew-on program



- touch «Buttonhole«-button
- touch «Button sew-on program»-icon

Darning foot No. 9 (optional accessory)
Button sew-on foot No. 18 (optional accessory)

Button sew-on program No. 60

For buttons with 2 and 4 holes.

Preparation

- lower the feed dog

Sewing on Buttons

Buttons sewn on for decorative purposes only are stitched without a thread shank. «Shank length» = distance between button and fabric; can be adjusted with Button sew-on foot No. 18

Sewing on buttons with darning foot No. 9 (optional accessory)

- select button sew-on program
- check distances between holes with the handwheel
- adjust stitch width if necessary
- hold the threads when starting to sew
- sew the first securing stitches into the left hole
- sew program
- ▶ sewing computer stops automatically when program is completed and is ready for the next button

Beginning and ending threads

The threads are secured and can be trimmed.

For a increased stability

- pull on both bobbin threads until the ends of the upper threads are visible on the wrong side
- pull the threads out and knot the ends additionally
- trim the threads

Sewing on buttons with foot No. 18 (optional accessory)

- set the shank length with the screw on the foot
- select button sewing-on program and continue as with foot No. 9

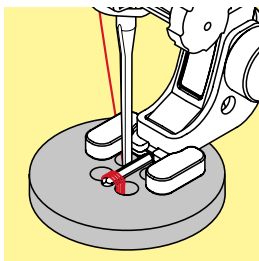
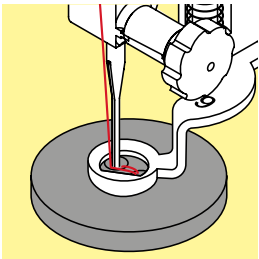

Sewing on a 4-Hole button

- sew the front holes first
- carefully move the button forward
- sew the back holes with the same program



For a increased stability the button sew-on program can be sewn twice.

Eyelet program



- touch «Buttonhole»-button
- touch «Eyelet program»-icon

Reverse pattern foot No. 1C

Eyelet with small zig-zag No. 61 Straight stitch eyelet No. 62



Sewing eyelets

- select eyelet
- position fabric under the presser foot and sew eyelet program
- ▶ sewing computer stops automatically and is at the beginning of the eyelet program again

Punching eyelets

- use an awl, punch pliers or a hole punch to open the eyelet



Adjust the roundness of the eyelet if necessary with balance.
For increased stability sew the eyelet twice.

Overview Decorative stitches

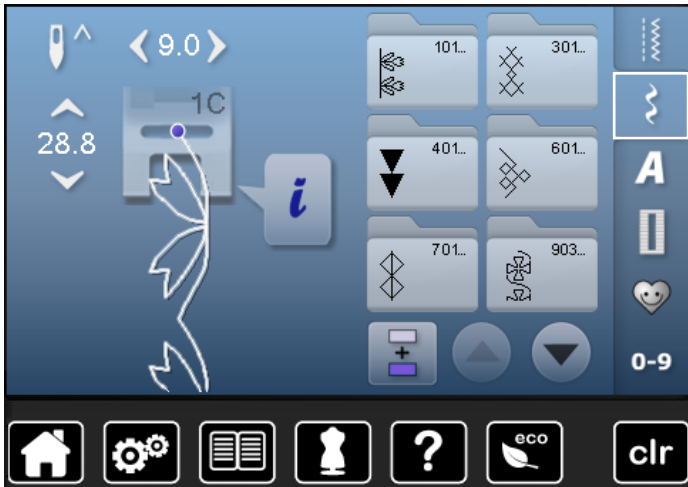

- touch «Decorative stitches»-button
- ▶ display shows an overview of the categories
- touch an icon
- ▶ the desired category is activated
- select the desired stitch pattern

Application

Depending on the type of material, simple or more complex decorative stitches should be selected to best suit the material.

- decorative stitches which are programmed with simple straight stitches, are particularly appropriate for light weight materials, e.g. decorative stitch No. 101
- decorative stitches which are programmed with triple straight stitches or with a few satin stitches are particularly appropriate for medium weight materials, e.g. decorative stitch No. 107
- decorative stitches which are programmed with satin stitches are particularly appropriate for medium weight materials, e.g. decorative stitch No. 401



Categories

- Cat. 100 = Florals
- Cat. 300 = Cross stitches
- Cat. 400 = Satin stitches
- Cat. 600 = Ornamental stitches
- Cat. 700 = Heirloom stitches
- Cat. 900 = Novelty
- Cat. 1300 = Quilt stitches



Perfect stitch formation

- use the same thread color for upper and lower thread
- reinforce the fabric on the wrong side using stabilizer
- use an additional, water-soluble stabilizer on the right side of pile or longfiber materials (e.g. wool, velvet etc.) which can be easily removed after sewing

Examples of application

Cross Stitches

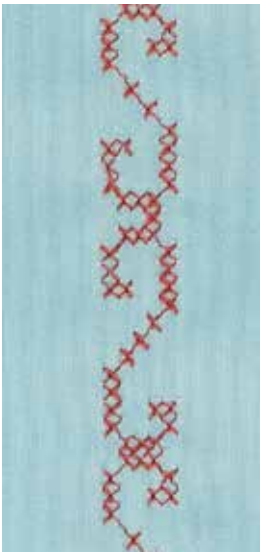

**Reverse pattern foot No. 1C or
Open embroidery foot No. 20C**

Cross stitch

- cross stitching is a traditional technique, and extends the range of decorative stitches
- if the cross stitches are sewn on fabric with a linen texture, they look like hand-stitched cross stitching

Application

- for home furnishings
- for trimmings on garments
- for embellishing in general

Sewing

Cross stitches of Category 300 can be stitched and combined like any other decorative stitches.

Sewing Trims

- select cross stitch
 - stitch a row, using the seam guide or slide-on table seam guide
- It is important to stitch the first row in a straight line, as it will serve as a reference for the rows that follow.
- select new stitch pattern
 - stitch a second row next to first at a distance of one presser foot's width, or using the seam guide
 - repeat for the following rows of stitching



Use cotton embroidery thread for cross stitching

Stitch appears fuller.

Pintucks



Pintuck feet (optional accessory)

- No. 30 (3 grooves) = 4mm double needle: for heavy weight materials
- No. 31 (5 grooves) = 3mm double needle: for heavy to medium weight materials
- No. 32 (7 grooves) = 2mm double needle: for light to medium weight materials
- No. 33 (9 grooves) = 1 or 1.6mm double needle: for very light materials (without additional pintuck cord)
- No. 46C (5 grooves) = 1.6-2.5 mm double needle: for very light to medium weight materials

Straight stitch No. 1

- this technique reduces the size of the fabric (allow for enough fabric)
- pintucks are narrow stitched folds which are normally sewn on the fabric before cutting out the pieces for garments or other sewing projects
- for embellishing or in combination with other heirloom embroidery techniques

Corded pintucks

- pintucks may be sewn with or without cord
- cord pintucks for a raised effect and texture
- chose a cord that fits well into the grooves of the selected pintuck foot
- the cord must be colorfast and shrinkproof

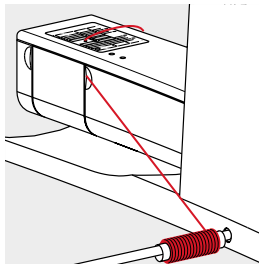
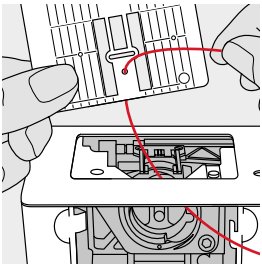

Inserting the cord

- remove the stitch plate of the sewing computer (see page 19)
- open the bobbin door
- pull the cord through the hook opening from the bottom and through the opening of the stitch plate
- replace the stitch plate
- close the bobbin cover
- make sure that the cord slides within the thread slot of the bobbin cover
- place the cord spool on the arm of the Free Hand System
- check that the cord runs smoothly

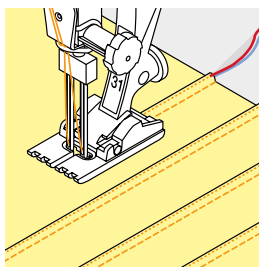

Sewing pintucks

- sew first pintuck, marking the stitching line if necessary
- ▶ the cord will automatically feed into the pintuck

The cord lies on the wrong side of the material and is hold/sewn over by the lower thread.

- turn work if necessary
- place first pintuck in one of the side grooves in the presser foot (depending on the desired distance)
- sew second pintuck
- sew additional pintucks parallel to these two



If the thread doesn't slide smoothly past the bobbin cover, open the cover while sewing and turn off the lower thread indicator in the Setup Program.

Bobbin-Play sewing



Free motion sewing

The bobbin can be filled different thread material. For free-motion stitching to add texture. This method is similar to «normal» free-motion sewing, but is done on the **wrong side** of the fabric.

Reinforce the area to be sewn with embroidery stabilizer. The design can be drawn on the wrong side of the fabric. You can also draw the design on the front of the fabric, then follow the lines with a freely guided straight stitch and polyester, cotton or rayon thread. The rows of stitching are visible on the right side of the fabric, and serve as reference lines for the bobbin-thread sewing.

The BSR function can be used for bobbin-thread sewing. Guide your project at uniform speed evenly under the needle, follow the lines of the design. Remove the stabilizer after you finish sewing.

Sew a sample first to check what the result looks like on the wrong side of the fabric. Alter the lower thread or upperthread tension if required.



To make the lower thread slide smoothly, insert the bobbin so that it turns counterclockwise.
The lower thread indicator has to be deactivated in the Setup Program (see page 45).



Sewing decorative stitches

Not all decorative stitches are suitable for this technique. Simple decorative stitches provide best results. Avoid compact stitch types and satin stitches.

The Open Embroidery foot No. 20 is ideal for this technique.

- adjust stitch length and width settings (widen, lengthen) so that nice results are also achieved when sewing with thicker threads
- the long stitch function produces another decorative effect

Overview Quilt stitches

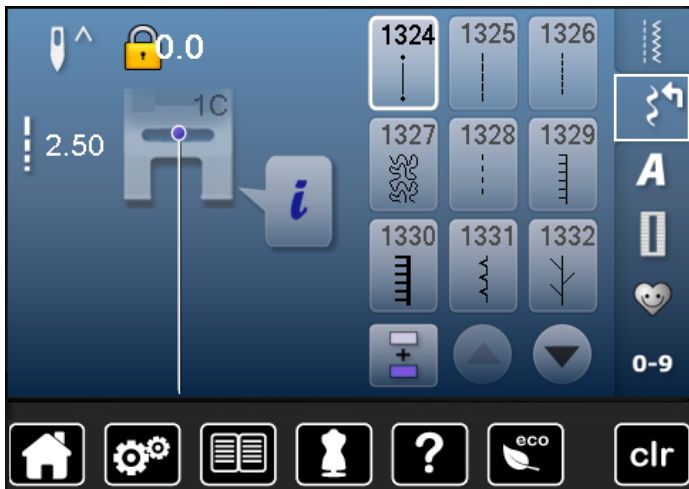

Various stitch patterns are available which are used especially in quilting, for patchwork or for appliqué.

- touch «Decorative stitch»-button
 - ▶ display shows an overview of the categories
- Cat. 1300 = Quilt stitches
- select desired stitch pattern
 - ▶ the stitch width cannot be altered with certain stitch patterns
 - ▶ is indicated by a lock symbol



1324 Quilters' securing program

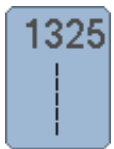

1325 Quilting straight stitch



1326 Piecing stitch/Straight stitch



1327 Stippling stitch



1328 Handlook quilt stitch



1329 Blanket stitch

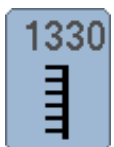

1330 Double blanket stitch

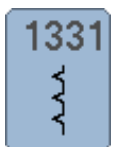

1331 Blind stitch (narrow)



1332 Feather stitch



1333 Feather stitch variations
1333-1335, 1337, 1338



1339 Decorative quilt stitch variations
1339-1345, 1351

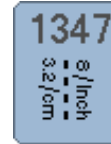

1347 Quilt stitch/Handlook quilt stitch variations
1347, 1348, 1350



1352 Blanket stitch (dual)

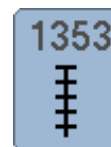

1353 Double blanket stitch (dual)



1354 Satin stitch

For free-motion quilting

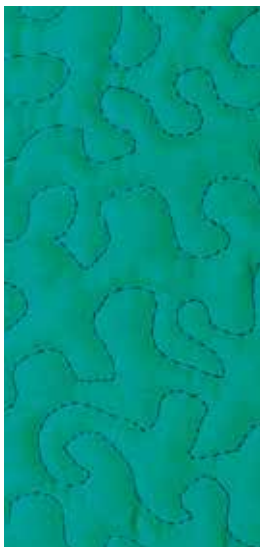

Darning foot No. 9 (optional accessory)

Straight stitch No. 1

For free-motion quilting

For all types of free motion quilting work.

Preparation

- pin top layer, batting and backing together, or baste if necessary
- attach slide-on table
- use the Free Hand System
- lower the feed dog

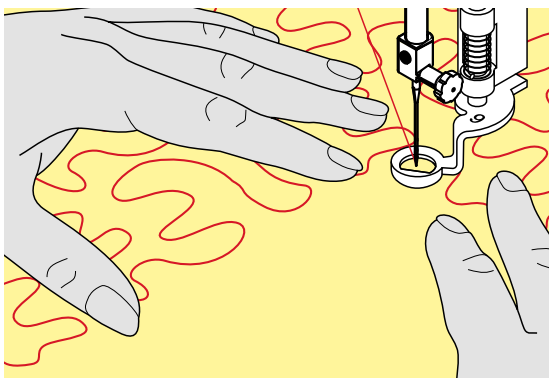

Holding the work

- hold the work with both hands like an embroidery frame



Quilt gloves with rubber fingertips will help when guiding the work.

Quilting a design

- quilt from the center outwards
- guide the work using smooth, round movements to form the design of your choice

Stipple quilting

- this technique covers the entire surface of the fabric with quilt stitches
- the lines of stitching are rounded and never cross one another



Free-motion quilting and darning

The two techniques are based on the same Free Motion principles.

Poor stitch formation

- if thread is lying on top of the fabric, slow down the movement of the material
- if there are knots on the wrong side of the fabric, move the material more quickly

Monofilament breaks

Reduce the motor speed and/or loosen the upper thread tension.

Thread breaks

Guide the fabric more consistently.

Quilting with BSR (optional accessory)



BSR-Function

The BSR presser foot reacts to the movement of the fabric under the foot and controls the speed of the sewing computer up to the maximum speed possible. The following applies: the faster the fabric is moved, the higher the speed of the sewing computer.

If the fabric is moved too fast, an acoustic signal (beep sound) is heard, if the Beeper is activated (see page 97).

ATTENTION!

As long as the BSR presser foot is illuminated red, adjustments like threading and changing the needle, for example, must not be carried out, as the needle will engage while fabric is moved unintentionally! Without fabric feed the BSR mode is turned off after approx. 7 seconds and the red light goes off.

Please refer to Safety Instructions!

By activating the BSR function the sewing computer sews either continuously at reduced speed (mode 1, standard), or as soon as the fabric is moved (mode 2).

BSR function with straight stitch No. 1

This function using the BSR presser foot, allows for free-motion quilting (sewing) using the straight stitch and a pre-selected stitch length up to 4mm. The regulated set stitch length is maintained within a certain speed, independent of the movement of the fabric.

BSR function with zig-zag No. 2

The zig-zag can be used e.g. for thread painting. The set stitch length will **not** be maintained when sewing with the zigzag stitch, but the BSR function simplifies the application.

There are two different BSR modes

- **BSR 1-Mode** is the active standard
- the sewing computer runs continuously at a reduced motor speed, as soon as the foot control or the «Start/Stop»-button is pressed
- the speed of the sewing computer is regulated by the movement of the fabric
- through continuous needle movement, securing in the same position is possible without pressing an additional button
- **BSR 2-Mode** is activated by selecting the BSR 2-icon in the BSR-display
- the sewing computer will only engage if the foot control or the «Start/Stop»-button is pressed and the fabric is moved simultaneously
- the speed of the sewing computer is regulated by the movement of the fabric
- to secure press the «Securing function»-button
- by selecting the BSR 1-icon in the BSR-display Mode 1 is activated



For an even sewing start (the first stitch) the foot control must be pressed and the fabric moved simultaneously. This also applies for sewing points and straight stitching within a round form.

If the BSR function is deactivated and later re-activated without the sewing computer being switched off in between, the last selected BSR mode is active.

When exceeding a certain speed, adhering to regular stitch length cannot be guaranteed.

Make sure that the lens on the bottom of the BSR foot is clean (no fingerprints, etc.). Clean lens periodically with soft, slightly damp cloth.

Preparation

- lower the feed dog
- presser foot pressure may be reduced depending on the material type and thickness
- attach slide-on table
- use the Free Hand System

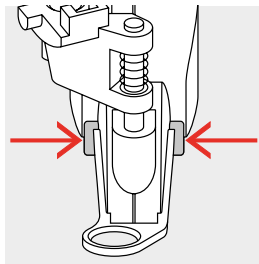

Remove presser foot sole

- press both buttons together
- slide the sole downwards out of the groove

Attaching the presser foot sole

- slide the desired sole up in the groove until it clicks into its place

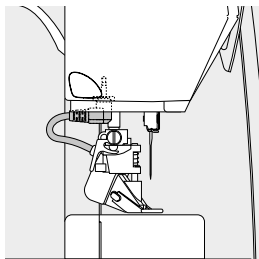

- attach the BSR Presser Foot to the sewing computer
- plug the cable in the outlet provided



- ▶ BSR-display is opened automatically
- ▶ BSR 1 mode is engaged
- set the desired stitch length
 - the standard stitch length is 2mm
 - when sewing small forms and stippings, stitch length of 1-1.5mm is suggested

Functions in the BSR mode

Needle stop down (standard)

- ▶ the arrow points down on the BSR-display
- ▶ the sewing computer stops with needle down, when taking foot off foot control or engaging the «Start/Stop»-button

Needle stop up

- touch the «Needle stop»-icon in the Display
- ▶ the arrow points up
- ▶ the sewing computer stops with needle up, when taking foot off foot control or engaging the «Start/Stop»-button

Raise or lower the needle

- press «Needle stop»-button
- ▶ to raise or to lower the needle

Securing with the «Start/Stop»-button (only Mode 1)

- place the fabric under the presser foot
- lower the presser foot
- press the «Needle stop»-button twice
 - ▶ the lower thread is brought up
- hold upper and lower thread
- touch «Start/Stop»-button
 - ▶ BSR mode is activated
- sew 5-6 securing stitches
- touch «Start/Stop»-button
 - ▶ the BSR mode is stopped
- cut threads
- touch «Start/Stop»-button
 - ▶ BSR mode is activated
- continue the stitching process

Securing function (only Mode 2)

- press the «Securing function»-button
 - press either the foot control or the «Start/Stop»-button
- By moving the fabric some short securing stitches are sewn, then the set stitch length will be activated and the securing function will be automatically deactivated.

Free motion quilting (only Mode 2)

- ▶ the BSR mode is activated
- freemotion quilting can be sewn
- by touching the securing function button is pressed during free hand quilting, a short securing stitch sequence is sewn and
 - ▶ the sewing computer stops
 - ▶ the BSR mode is deactivated

Free motion quilting without BSR activation

- touch «BSR»-icon
 - the BSR mode is deactivated
- Normal freemotion quilting can now be sewn with the BSR foot, without automatic regular stitch length.



Beeper (Acoustic signal) activation/deactivation

- touch «Setup»-button
- touch «Audio setting»-icon



Selecting sound for BSR in the Setup Program

- ▶ one sound is set as default (active)
- touch the icon 1 showing the loudspeaker for BSR
- ▶ the loudspeaker is highlighted in red
- ▶ the sound for the beeper is inactive

The loudspeaker is gray when the sound for the Beeper is active.

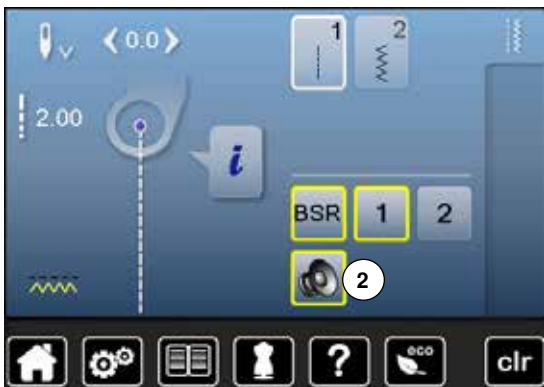

Selecting sound for BSR in the «BSR»-display

- touch the icon with the loudspeaker
 - ▶ the loudspeaker is highlighted in red
 - ▶ the sound for the beeper is inactive
- The icon with the loudspeaker is gray and yellow-framed when the sound for the Beeper is active.



The sound selection icon 2 is only visible if the sounds are turned on in the Setup Program.

Activating the BSR Sewing Function

1. Option:

BSR-Function via the foot control.

- plug in the foot control
- lower the presser foot
- press the foot control
- ▶ BSR mode starts
- ▶ a red light appears on the presser foot
- press foot control while sewing
- the speed of the sewing computer is regulated by the movement of the fabric
- release the foot control
- ▶ the BSR mode is stopped

2. Option:

BSR-Function via the «Start/Stop»-button.

- lower the presser foot
- touch «Start/Stop»-button
- ▶ BSR mode starts
- ▶ a red light appears on the presser foot
- the speed of the sewing computer is regulated by the movement of the fabric
- press the «Start/Stop»-button again
- ▶ the BSR mode is stopped

Deactivating the BSR Sewing Function by using the «Start/Stop»-button Mode 1

If the fabric is not moved for approx. 7 seconds, the BSR mode is deactivated and the red light on the presser foot goes off.

Mode 2

If the stitching process is ended by no longer moving the fabric, **one** additional stitch is made, depending on the needle position. The sewing computer always stops with needle up, even if the arrow on the Display points down.

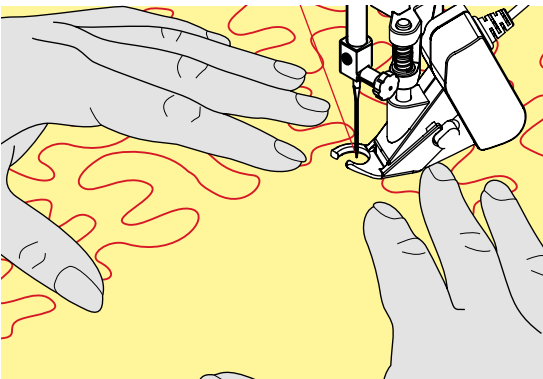

Holding the work

- hold the work with both hands like an embroidery frame
- abrupt movements (slowing down resp. speeding up) can result in slightly too short or too long stitches
- continuous movement (no abrupt movements) will provide best results
- do not pivot the fabric while sewing



Quilt gloves with rubber fingertips will help when guiding the work.



Application example:

- BSR with zig-zag No. 2
- the zig-zag can be used for thread painting
- areas can be filled and therefore forms or pictures can be created

BSR Function deactivation

- pull out the plug of the BSR presser foot connection cable on the sewing computer
- remove the BSR foot

Overview Alphabet

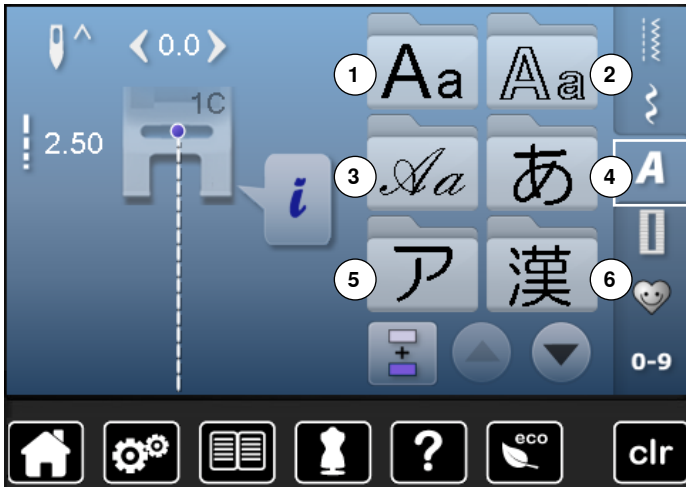

Block-, Double Block- and Script alphabet can be sewn in two different sizes.

Block-, Double Block- and Script alphabet can also be sewn in lower case.

- touch «Alphabet»-button
- ▶ the Display shows the overview with the different alphabet types

- 1 Block alphabet
 - 2 Double Block
 - 3 Script (Italics)
 - 4 Hiragana
 - 5 Katakana
 - 6 Kanji
 - 7 Kyrillic
- select desired alphabet



Lettering

- all capital letters, numbers, punctuation marks and special characters can be viewed using the arrow icons

Perfect stitch formation

- use the same thread color for upper and lower threads
- reinforce the fabric with embroidery stabilizer on the wrong side
- use an additional, water-soluble stabilizer on the right side of pile or longfiber fabrics (e.g. wool, velvet etc.)
- for lightweight fabrics more simple lettering types programmed with straight stitches are suitable (such as double block letters)

Combining lettering

Individual letters and rows of the same letter of the same alphabet are sewn in single mode.

Letters for names, addresses, words, etc. are combined and sewn in combi mode.



- touch «Combi mode»-icon
- touch the icon with the desired letter
- ▶ the letter appears in the Stitch altering area
- ▶ the cursor is below the letter



Selecting the next letter

- touch the required icon
- ▶ the next letter appears in the Stitch altering area etc.

Correcting the combination



Inserting lettering

A letter is always inserted above the cursor.

Inserting an additional letter at the beginning of a pattern combination:

- move the cursor up by using the arrow icons
- Activating desired place:
- select or scroll to required letter in the Stitch altering area
- select new letter
- ▶ letter is inserted above cursor

Deleting Letters

A letter is always deleted above the cursor.

Activating desired place:

- select or scroll to the required letter in the Stitch altering area
- touch «Delete»-icon
- ▶ letter is deleted

Saving and deleting combinations see page 106, 110.

Alphabet in combination with functions



Select lower case

- touch the «Upper/Lower case»-icon
- ▶ the lower case «a» is highlighted in black and jumps to the upper left corner of the icon
- ▶ the lower case is activated
- touch the «Upper/Lower case»-icon again
- ▶ the upper case «A» is highlighted in black and jumps to the upper left corner of the icon
- ▶ upper case is activated again



Change size

- touch «i»-icon
- touch «Lettering size»-icon
- ▶ the icon with the number 2 turns blue
- ▶ the font size is reduced
- touch the «Lettering size»-icon again
- ▶ larger size is activated again (number 1 is highlighted in blue)

Personal program

Creating a Personal Display

Use the Personal program to create a file with stitches you use most for a special project. Stitch patterns as well as their alterations are saved in the Personal program.



The following alterations can be saved:

- Stitch width
- Stitch length
- Needle position
- Thread tension
- Mirror image
- Pattern extend
- Long stitch
- Balance
- Pattern repeat 1-9x

If the memory has already been filled with embroidery motifs and stitch pattern combinations, no further stitch patterns can be saved in the Personal program. An appropriate message appears. The content in the memory must first be deleted to ensure there is sufficient free space.

Preparing stitch patterns



Programming/Saving first stitch pattern

- select e.g. the zig-zag in the «Practical stitch»-display
- make alterations

- touch «Personal program»-button 1



- touch «Save»-icon 2



- touch «Save»-icon 3
- ▶ the altered zig-zag is saved
- ▶ the Display closes



Programming/Saving second stitch pattern

- touch «Buttonhole»-button
- select standard buttonhole No. 51
- save the stitch pattern as described above
- save any other stitch pattern in the same way



Stitch pattern selection in the Personal program

- touch «Personal program»-button



- touch «Open»-icon 4



Personal Display

- ▶ the programmed stitch patterns are displayed in pictures as well as with stitch width and stitch length
- further stitch patterns can be scrolled by using the arrow icons

Alerting/Overwriting stitch patterns



Selecting stitch pattern

- touch «Personal program»-button 1
- select zig-zag
- make alterations
- ▶ stitch width and stitch length are altered (yellow numbers)
- touch «Personal program»-button
- touch «Save»-icon



- select zig-zag 2

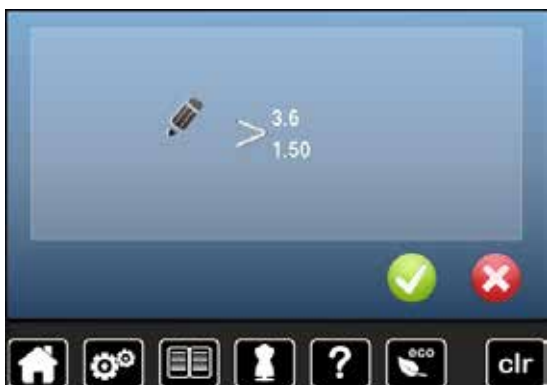

- confirm with ✓
- ▶ the alterations are saved

Deleting stitch patterns



Selecting stitch pattern

- touch «Personal program»-button
- touch «Delete»-icon 1



- select the stitch pattern to be deleted



- confirm with ✓
- ▶ stitch pattern is deleted
- ▶ the remaining stitch patterns are moved by one position

Combi mode

The sewing-/embroidery computer has a memory system where both, the sewing and embroidery memories are saved.

In the sewing memory stitch patterns, lettering and numbers can be combined and saved.

In the sewing memory each «Drawer» can store a maximum of 70 stitch patterns as long as there is sufficient free space (capacity) available. If the storage space (but not all drawers) is full, there may be too many embroidery designs in the memory.

The memory is long-term, i.e. contents are kept until they are deleted. A power cut or switching off the sewing-/embroidery computer does not have any effect on the stored contents.

Creating stitch combinations



Programming and saving

- touch «Decorative stitch»-button
- select category
- touch «Combi mode»-icon
- select the desired stitch pattern directly or type in the number
- make any alteration concerning stitch length, stitch width, needle position etc.
- select another stitch pattern

- 1 ■ touch «Memory»-icon 1



- touch «Save»-icon 2



- touch «Save»-icon 3
- ▶ the combination is saved
- ▶ the Display closes

Deleting Stitch Patterns



Deleting patterns in steps

- touch the «Delete»-icon
- ▶ stitch pattern above the cursor are deleted
- touch the «Delete»-icon as many times until the stitch altering area is empty



Deleting combination

- touch «i»-icon
- touch «Edit the complete combination»-icon
- touch the «Delete»-icon
- confirm with ✓
- ▶ the stitch altering area is empty
- touch «Back»-icon
- a new pattern combination can be programmed

Opening a saved combination



- touch «Memory»-button
- touch «Open»-icon 1

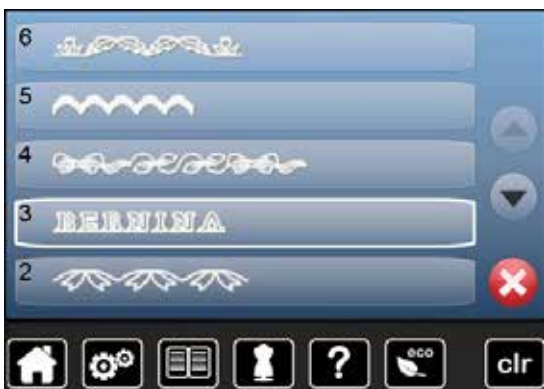

- ▶ a summary of the saved combinations appears
- touch the desired drawer
- ▶ the saved combination appears in the stitch altering area

Correcting a stitch pattern combination



Inserting a stitch pattern

- select the desired position in the combination
- select the new stitch pattern
- ▶ the new stitch pattern is inserted below the selected stitch pattern



To insert a stitch pattern at the beginning of a combination the cursor must be positioned above the **first** stitch pattern.



Altering stitch patterns

- select the desired stitch pattern in the combination
- touch «i»-icon
- select desired function, e.g. Mirror image left/right
- ▶ the stitch pattern is mirrored left/right
- touch «Back»-icon



The alterations always affect the stitch above the cursor. Saved stitch combinations can be altered or corrected in the same way. To make corrections and alterations permanent, the combination must be saved again afterwards.



Mirroring complete combinations

- touch «i»-icon
- touch «Edit complete combination»-icon
- touch «Mirror image»-icon
- ▶ the complete combination is mirrored
- touch «Back»-icon twice



Combination subdivider 1

- touch «i»-icon
- touch «Edit combination at cursor position»-icon
- touch «Subdivide combination 1 »-icon
- a combination can be subdivided into several sections with the «Subdivider 1 »-function
- ▶ only the section where the cursor is positioned is sewn
- to sew the next section, the cursor must be placed in the respective section



Interrupting a combination

- touch «i»-icon
- touch «Edit combination at cursor position»-icon
- touch «Subdivider 2»-icon
- a combination can be interrupted at any position using «Subdivider 2»-function
- sew the first section
- ▶ the sewing computer stops automatically when it reaches the programmed function
- reposition the fabric
- sew the next part etc.

Stitch pattern combination



Overwriting

- program a new stitch combination
 - touch «Memory»-button
 - touch «Save»-icon
 - select the drawer to be overwritten (e.g. 3)
 - confirm with ✓
- Touch ✗ to cancel the overwriting procedure.



Deleting

- touch «Memory»-button
 - touch the «Delete»-icon
 - select the Drawer to be deleted (e.g. 5)
 - confirm with ✓
- Touch ✗ to cancel the deleting procedure.

Embroidery - Contents	111
Accessory	112
Preparation <ul style="list-style-type: none"> ■ Overview Embroidery module 113 ■ Preparing for Embroidery 114 	113
Functions <ul style="list-style-type: none"> ■ «Function»-buttons Embroidery computer 122 ■ Overview Display 123 	122
Embroidery Motifs	135
Cleaning	158
Troubleshooting	159
Stitch patterns	164
Motifs	171
Index	182

Standard Accessory



- Embroidery foot No. 26
- Embroidery bobbin case
- Embroidery needle pack
- Embroidery hoop oval, 145x255mm
- Embroidery template for embroidery hoop oval, VAR 01
- Embroidery hoop medium, 100x130mm
- Embroidery template for medium embroidery hoop
- Net for thread spool
- USB connecting cable
- Carrier bag

Detail view

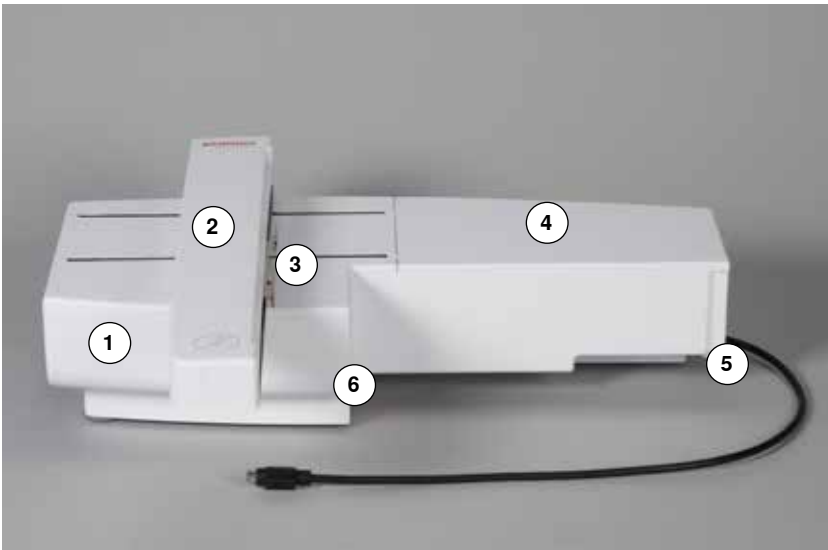

- 1 Accessory drawer
- 2 Embroidery arm
- 3 Bracket for attaching embroidery hoop
- 4 Embroidery surface
- 5 Connecting lug right
- 6 Connecting lug center

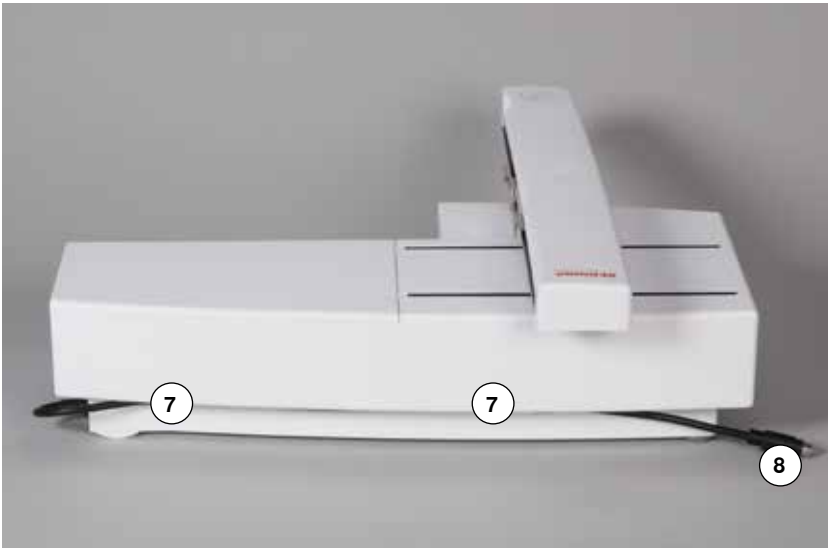

- 7 Cable holder
- 8 Sewing computer connecting cable



The side view of the sewing-/embroidery computer with the cable connections are shown on page 11 of this sewing-/embroidery computer instruction manual.

Embroidery module

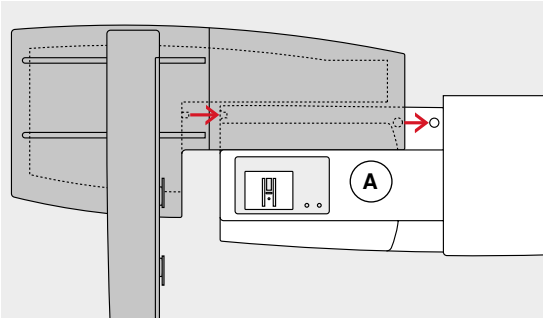

ATTENTION!

When connecting the embroidery module, attention must be paid that all items are on a flat and even surface! Always separate the module and sewing computer for transportation. Never transport them attached.

Attaching the module to the sewing computer

- place the module behind the free arm **A** to the sewing computer
- push the module from the left towards the sewing computer so that the connecting lugs engage

The module must be engaged in the base plate of the sewing computer.

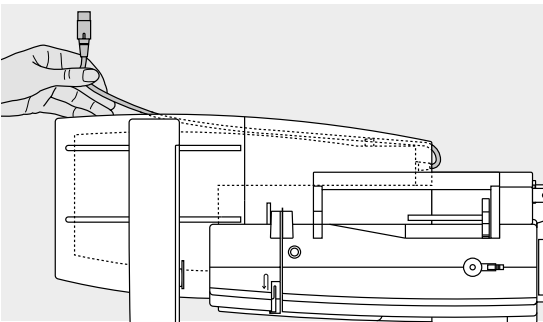

Connection cable

The cable connects the module and the sewing computer.

- pull the cable out of the holder on the back of the module

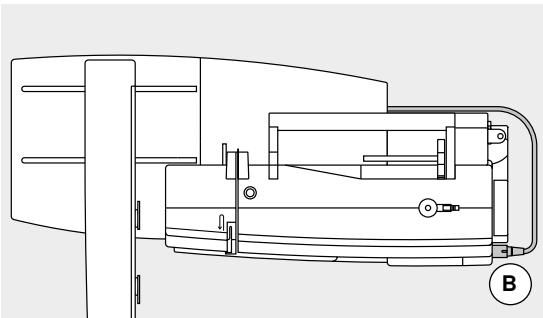

Connecting the cable with the sewing computer

- hold flat side to the front
- plug the cable into the outlet provided **B**

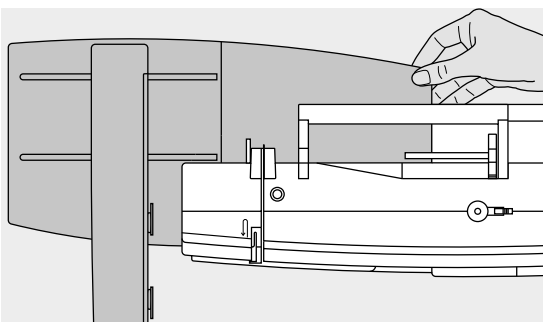

Removing the module

- remove the plug from the outlet
- grip the back right corner to lift the module
- lift the module and remove to the left

Storing the cable on the module

- insert the cable into both cable holders
- press cable into the cable holders



Calibrating the hoop

Adjust Reference Position calibrates the needle to the center of the hoop. Adjustments can only be made if the embroidery module as well as the oval hoop are attached, see page **43**.

Embroidery mode

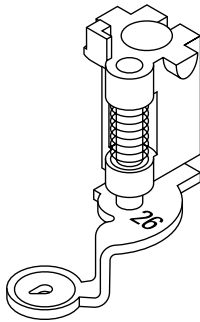

Embroidery needle

Embroidery needles (130/705 H-SUK) provide a larger eye and are slightly rounded. This avoids thread abrasion when using Rayon- and cotton embroidery thread.

- use SUK-needles
- depending on the embroidery thread use a size No. 70-SUK to No. 90-SUK needle
- use a new needle

Preparation

- attach embroidery foot No. 26 to the embroidery computer
- raise the presser foot
- raise the needle



Lowering the feed dog

- press «Feed dog»-button **A**
- ▶ the feed dog is lowered

Straight-/CutWork stitch plate (optional accessory)

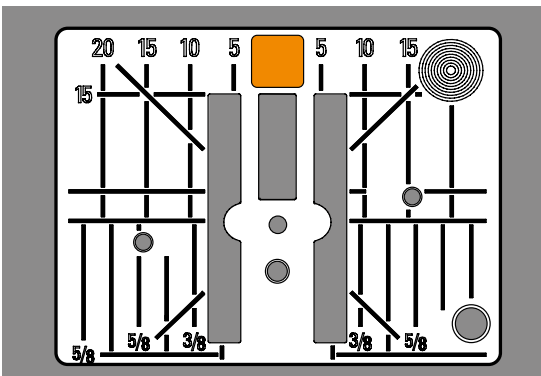

The straight-/CutWork stitch plate has a small needle hole in the needle insertion area. The small needle hole supports the fabric. This optimizes the stitching results.

- remove the standard stitch plate (see page 19)
- replace it with the straight-/CutWork stitch plate

Threading upper and bobbin thread

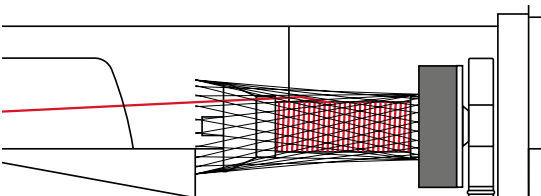

Threading upper thread

- place foam pad
- attach thread spool
- when using Rayon or slippery embroidery threads, slip the net over the upper thread spool
- ▶ this will feed the needle thread more evenly



Spool pin

When working with metallic or any other special threads always use the vertical spool pin and the guide eyelet for metallic and silk thread (optional accessory).



Threading bobbin thread

- thread the lower thread into the pigtail tension guide of the bobbin case



Insert the embroidery bobbin case and close the bobbin cover afterwards to activate the lower thread indicator (must be activated in the Setup-Program).

Embroidery hoop

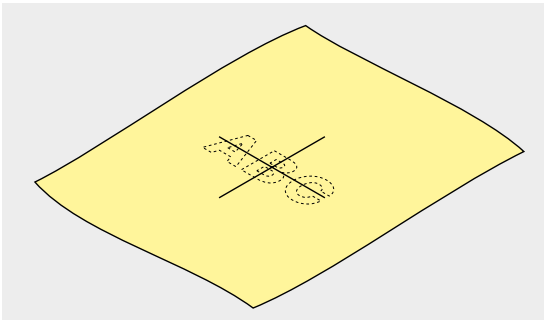

Center determination

- determine the center of the material to be embroidered
- mark the material with fabric marker or chalk

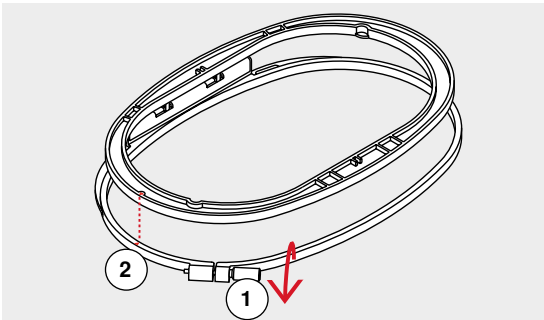

Using the embroidery hoop

- loosen the screw **1** of the outer hoop if necessary
 - remove the inner hoop
- Match the arrows **2** of both hoops.

The arrows are

- on the oval and medium hoop at the center front
- on the Mega Hoop (optional accessory) at the center front
- on the small hoop (optional accessory) to the right side

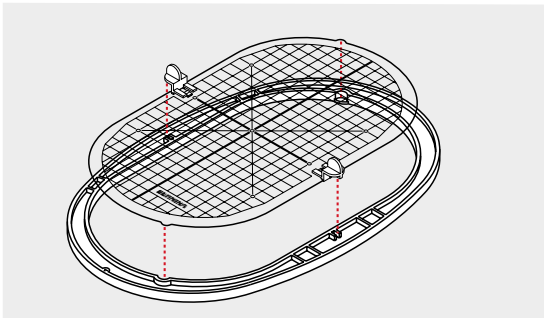

Embroidery template

- there is an embroidery template for each hoop
- the embroidery area is marked in 1 cm squares
- the center and end point holes of the center lines are with holes
- for transferring marks to the material
- attach the embroidery template holder
- place the template in the inner hoop, so the BERNINA logo is at the front edge (by the arrows) and can be read
- ▶ in this position the embroidery template clicks into the inner hoop

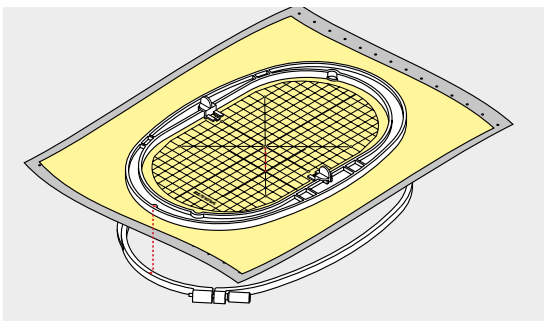

Hooping the material

- place the material under the inner hoop
- line up the marked center point on the center of the template
- place the material and inner hoop on the outer hoop

Match the arrows of both hoops.

- fit hoops into each other; ensure that the material does not move
- hoop the material to be embroidered tightly
- tighten the screw
- remove the template from the hoop by using the template holder

Stabilizer

Stabilizers

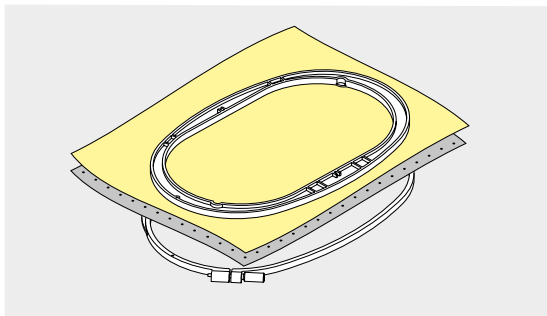

Tear-away stabilizers

- excess is easily torn away
- one or more layers can be used
- available in different weights
- for more stability, apply to the wrong side of the material with temporary adhesive spray before hooping
- carefully tear away excess stabilizer from the back of the embroidery after stitching
- motifs are not skewed
- stabilizer will remain under larger embroidered areas

Application:

For all woven materials and materials without stretch.

Cut-away stabilizers

- one or more layers can be used
- available in light and heavy weight
- for more stability, apply to the wrong side of the material with temporary adhesive spray before hooping
- carefully cut away from the back of the embroidery after stitching
- motifs are not skewed
- stabilizer will remain under larger embroidered areas

Application:

For all elastic materials.

Adhesive Spray

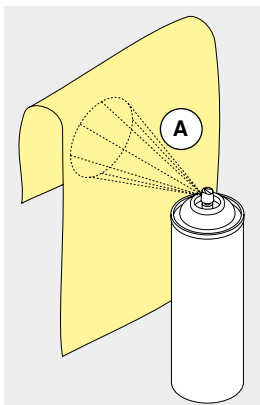

Please avoid using adhesive spray next to your embroidery system.

- distance **A**: 25-30cm
- use adhesive spray carefully
- spray the stabilizer and adhere to the wrong side of the material carefully smoothing material so there are no puckers

Application:

- stretch and knitted material: to retain shape
- smooth material: to avoid slipping of material layers
- appliqués can be exactly positioned
- material pieces: position material pieces on stabilizer, e.g. pocket flaps
- napped materials (i.e. velvet) that should not be clamped in the hoop because of the possibility of getting hoop marks
- to fix parts to be embroidered

Spray starch for additional stiffening

Spray starch is ideal for additional stiffening fine, soft or loosely woven materials.

- spray the area to be embroidered
- let dry; or press gently with a warm iron if necessary

Always use an additional stabilizer such as water soluble stabilizer on the wrong side of the material.

Application:

Ideal for fine, loosely woven materials, e.g. batiste, fine linen, etc.

Iron-on interfacing

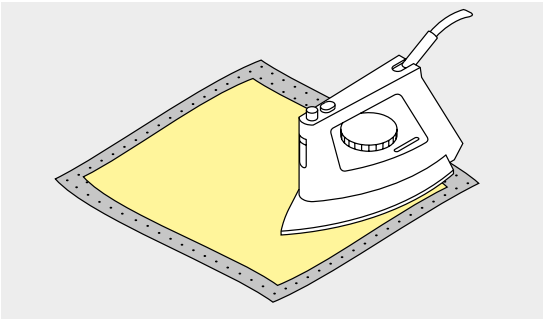

Iron-on interfacings are available in a variety of weights. Iron-on interfacings should be selected to suit the material being used. Use an iron-on interfacing which is easily removable from the material.

- iron-on interfacings are pressed (fused) to the wrong side of the material

Application:

To provide body and shape for materials onto which motifs will be placed, use in conjunction with appropriate stabilizer.

Paper-backed adhesive stabilizer

- place stabilizer in hoop, paper side up
- use a pointed object (e.g. scissors) to score the paper
- remove paper to reveal the self-adhesive surface
- ▶ the self-adhesive surface reveals
- position the material to be embroidered on the stabilizer and smooth in place

Application:

- intended for delicate materials such as jersey or silk etc.
- for hard to hoop materials and materials such as velvets



Make sure that the adhesive residue on needle, stitch plate and hook area is removed.

Water soluble stabilizer

Water soluble stabilizer looks like plastic wrap. Dissolve stabilizer in warm water when the embroidery is complete. Water soluble stabilizers are ideal protection for materials with a thick or looped pile such as toweling. This prevents the threads from sinking into the material and prevents the material from showing through the embroidery stitches.

- place on top of the material
- place all the layers together into the embroidery hoop
- use adhesive spray to fix stabilizer if necessary
- for material with a pile, reinforce with additional, suitable stabilizer on the wrong side
- after dissolving lay the motif down flat and let dry

Application:

- ideal for toweling, velvet, bouclé etc.
- ideal for fine, sheer materials such as organdy, batiste, etc.
- for lace embroidery



For lace embroidery place one or two layers of water soluble stabilizer in hoop (as the motif is not embroidered on any material, only the thread embroidered motif is left). Embroidery motifs must be combined with short stitches otherwise the individual motifs may fall out.

Important embroidery information

Embroidery threads

A good quality thread is essential for embroidery to avoid poor stitch quality, thread breakage, etc.

Embroidery is particularly effective if you use 40wt glossy rayon or polyester embroidery threads as upper threads. They are available in a wide range of colors for beautiful embroidery.



Polyester threads

Polyester with a brilliant sheen is a hard wearing colorfast thread and has a high tensile strength which is suitable for all types of embroidery.

Rayon threads

Rayon is a soft viscose fiber with a brilliant sheen and suitable for fine, delicate embroidery, or items that will not receive excessive wear and tear.

Metallic threads

Metallic thread is a light- to medium weight thread suitable for special effects in embroidery. Reduce the speed and upper thread tension when embroidering with metallic threads.

Embroidery needle

- correct size thread must correspond with correct size needle
- replace the needle regularly



Use the vertical spool pin and attach the supplemental thread guide (optional accessory) when using guide eyelet for metallic and silk thread. A Metafil 130/705H-MET need is recommended for embroidering with metallic threads. Adjust upper thread tension and reduce the embroidery speed.

Lower threads



Bobbin Fil (special bobbin thread)

Bobbin Fil is an especially soft and light polyester thread suitable for bobbin thread. This special bobbin thread ensures a steady thread tension and an optimal intertwining of the upper and bobbin thread.

Darning and embroidery thread

Fine mercerized cotton thread which suits for embroidering on cotton.



In most cases, bobbin thread for embroidery is either white or black. Some special cases require same thread in top and bobbin.

Choosing the embroidery motif

Simple motifs with a low stitch count are suitable for embroidery on fine material. Large-scale, densely embroidered motifs (e.g. with multiple color and embroidery direction changes) are suitable for medium and heavy weight material.

Embroidery test

Always test stitch the embroidery motif on the same type material. Use the same stabilizer as will be used on the finished project. Changes colors, stabilizer type or needle if needed to suite the motif/fabric combination.

Scaling/Sizing motifs

Motifs can be scaled/sized using the on-screen icons or with the BERNINA Embroidery Software on the PC. Increasing/decreasing in a range of +/- 20 % provides the best results.

Different stitch types

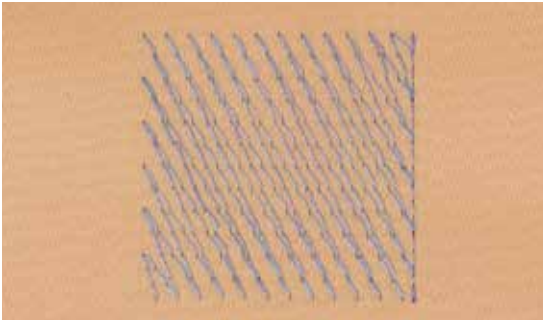

Underlay stitches

Underlay stitches are the foundation of a motif and are used to stabilize the base material and hold it in shape. They also prevent the covering stitches of the motif from sinking into the knit or the nap of the material.

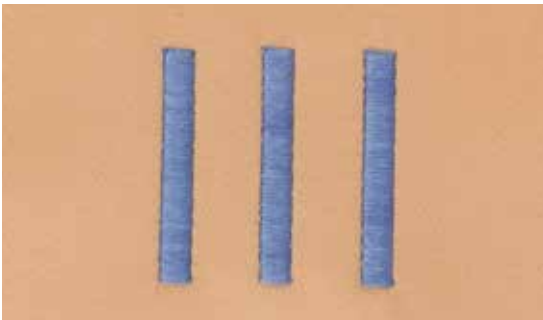

Satin stitch

The needle moves left to right and vice versa. The result is a very dense, covering zig-zag stitching to fill the shape. Satin stitching fills are ideal for narrow and small shapes. Satin stitching is, however, not suitable for larger areas, since wide stitches are too loose and do not cover the fabric properly. In addition there is the danger that with too long stitches the threads could catch on something which would damage the embroidery.

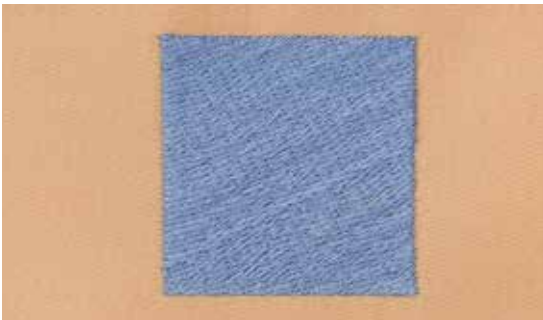

Step stitch

A fill stitch with stitches of specified length sewn in rows used primarily to fill large areas quickly.

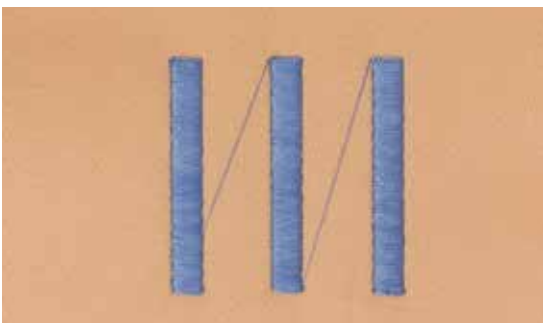

Connecting Stitches

Jump stitches which are used to get from one part of the motif to the next. Before and after the jump stitch securing stitches are sewn. Jump stitches are trimmed before the next color starts to embroider.

Overview «Function»-buttons embroidery computer



«Start/Stop»-button

Press «Start/Stop»-button to start or stop the embroidery computer.



«Automatic thread cutter»-button

When a color finished embroidering, upper and lower threads are automatically cut.

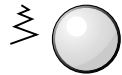

Stitch width and stitch length knob

The knobs provide different functions and are used to edit the motifs, e.g. altering motif size, to rotate the motif etc. A message appear to indicate the knobs must be used.

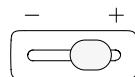
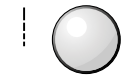

Speed control

The sewing and embroidering speed is infinitely variable with the slide.

Overview Display

Entry to Embroidery mode



- press «Home»-button



Embroidery mode

- touch «Embroidery mode»-icon 2
- ▶ the «Embroidery»-display appears

Sewing mode

- press «Sewing mode»-icon 1
- ▶ the «Sewing»-display appears

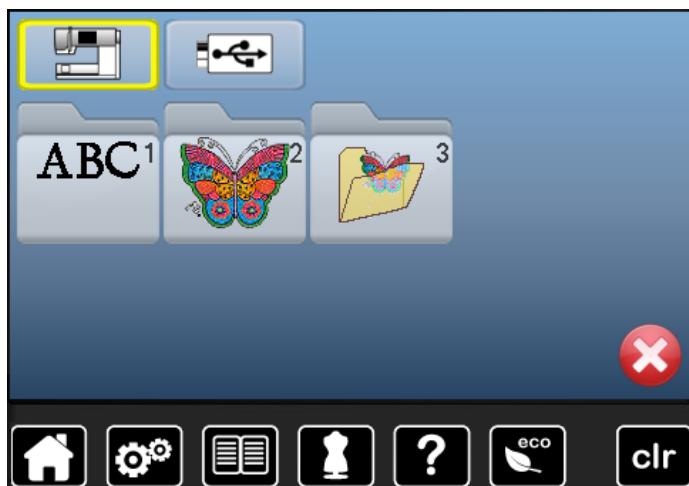

Embroidery computer

To select embroidery motifs from the folders «Alphabets», «Motifs», or «My Designs».



USB-Stick (optional accessory)

To select embroidery motifs which are saved on the USB stick.



Alphabets

To select built-in alphabets.



Embroidery motifs

To select built-in embroidery motifs.



My Designs

To select saved embroidery motifs.

Embroidery Alphabet

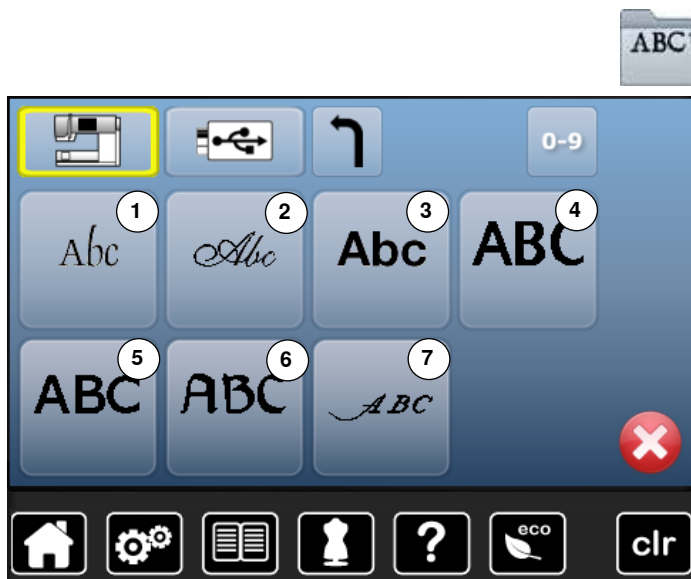

■ touch «Alphabet»-icon

■ select desired alphabet

- 1 King Charles
- 2 Anniversary
- 3 Swiss Block
- 4 London
- 5 Chateau
- 6 Guinevere
- 7 Emerald



Return to selection menu
Back to the «Selection»-display.

BERNINA motif

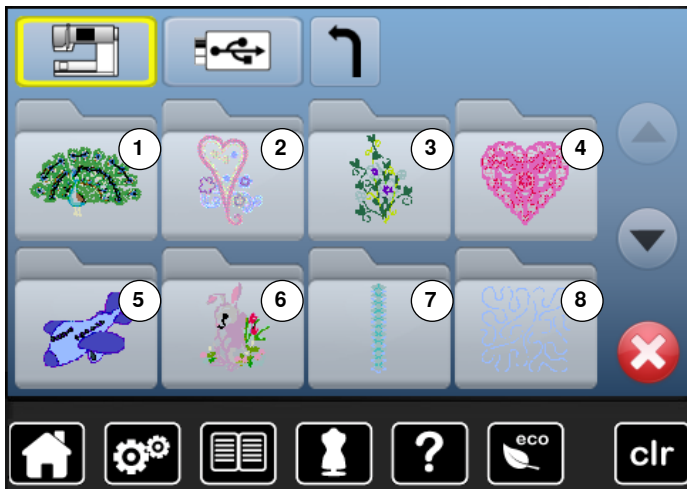

- touch «Embroidery motif»-icon
 - select desired embroidery motif folder
- 1 Animals
 - 2 Embellishment
 - 3 Florals
 - 4 Lace
 - 5 Children
 - 6 Seasons
 - 7 Borders
 - 8 Quilt

My Design



- touch «My Design»-icon
- touch the desired motif

Embroidery motif from USB-Stick (optional accessory)



- insert USB-Stick
- touch «USB-Stick»-icon
- touch the desired motif

«Edit»-display

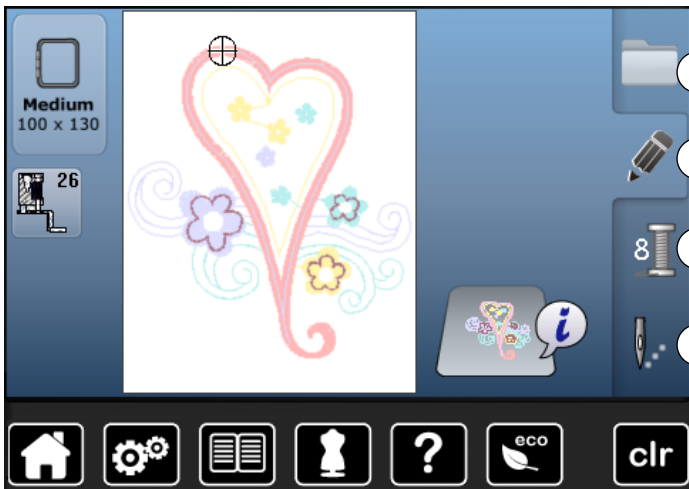

- A Selection
- B Edit
- C Color Numbers
- D Embroidery Menu

Overview «Edit»-display

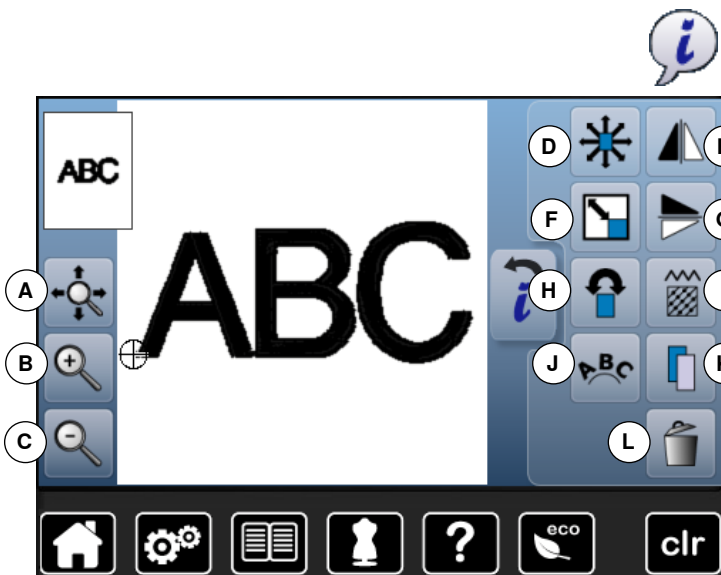

- select alphabet or motif
- touch «i»-icon

Some functions feature tips for the operating of the stitch width and stitch length knobs.

Functions

- A Moving the enlarged motif within the hoop
- B Zoom plus
- C Zoom minus
- D Move motif
- E Mirror Image (Left/Right)
- F Enlarging or reducing motif proportionally
- G Mirror Image (down/up)
- H Rotate motif
- I Change Stitch Type
- J Letter manipulation
- K Duplicate motif
- L Deleting motif

General Functions



Information

- touch the button
- ▶ another Display is opened



Back

- touch the button
- ▶ goes back to the previous Display
- ▶ any alterations are accepted



Confirming selection

- touch the button
- ▶ Alteration/Selection is activated or confirmed.



Leaving the active Display

- touch the button
- ▶ the Display is closed
- ▶ the previous Display appears



Moving the enlarged motif within the hoop

The embroidery motif can be moved within the hoop to any direction using the touch pen or the finger directly in the Display.



Zoom plus

- touch icon 1-5x
- ▶ the Displayed embroidery is enlarged by one step



Zoom minus

- touch icon 1-5x
- ▶ the Display of the enlarged motif is reduced by one step



Moving the motif

Display of the alteration in 1/10mm.

- turn stitch width knob
 - ▶ the motif is moved in sideways (horizontally)
- turn stitch length knob
 - ▶ the motif is moved lengthwise (vertically)
- turn stitch width and stitch length knob
 - ▶ the motif is moved diagonally (the same number is in both icons)

By using the finger or the touch pen the motif can also be moved to any direction.



Change Stitch Type

Satin stitches can be changed to step stitches (fill stitches).

Altering Stitch Density.



Letter manipulation

- turn stitch width knob
 - ▶ the distance between the characters is altered in mm-steps
- turn stitch length knob
 - ▶ the text is bent upwards or downwards



Mirror image (Left/Right)

The motif is mirrored horizontally (Left/Right).



Duplicating motif

Active embroidery motif is duplicated.



Altering the motif proportionally

Displayed alteration in %.

- turn stitch width knob to the right
 - ▶ the motif is enlarged
- turn stitch width knob to the left
 - ▶ the motif is reduced



Deleting motif

Active embroidery motif is deleted.



Mirror image up/down

The motif is mirrored vertically (up/down).



Rotate motif

Display of position in degrees (°).

- turn stitch width knob to the right
 - ▶ the motif rotates to the right
- turn stitch width knob to the left
 - ▶ the motif rotates to the left
- touch «+90»-icon 1-4x
 - ▶ the motif rotates to the right in 90°-steps (0°, 90°, 180°, 270°, 360°)

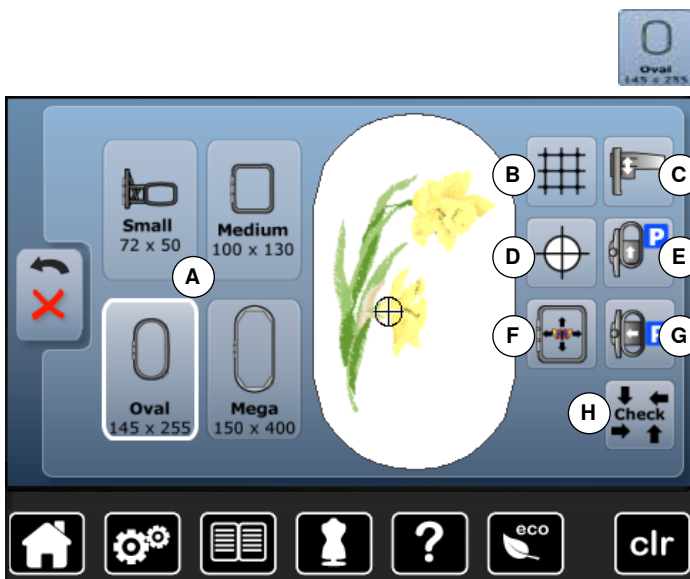

- touch «Hoop size»-icon

With some functions the instruction to use the knobs appears.

Functions

- A Select Hoop Menu
- B Grid
- C Calibrating the embroidery module
- D Motif center
- E Move hoop to back
- F Virtual positioning
- G Parking the module
- H Check hoop and motif size

General Functions



Information

- touch the button
- ▶ another Display is opened



Back

- touch the button
- ▶ goes back to the previous Display
- ▶ any alterations are accepted



Confirm Selection

- touch the button
- Alteration/Selection is activated or confirmed.



Leaving active Display

- touch the button
- ▶ the Display is closed
- ▶ the previous Display appears



Select hoop menu

- ▶ the optimal hoop for the motif selected is displayed
- touch the button
- ▶ the Display with the Select Hoop and further functions appear



Grid

Grid appears to position the embroidery motif accurately.



Calibrating the embroidery module

- touch the button
- ▶ the module is calibrated (reads the reference points)

No embroidery hoop must be attached!



Motif center

The exact motif center is indicated by the cursor. The embroidery hoop is moved until the needle is positioned exactly in the center of the embroidery motif when the function «Virtual positioning» is activated.



Move hoop to back

- ▶ the hoop moves vertically to the far back
- Better access for changing the bobbin.



Virtual Positioning

Icon is inactive = if the motif is repositioned, the hoop does not move.



- touch the button
- If the motif is repositioned, the hoop simultaneously moves along with it to the new position.



Parking the embroidery module

- remove embroidery hoop
- ▶ the embroidery arm travels horizontally to the left to the park position
- change to the sewing mode

Sewing is possible even with the embroidery module attached.



Check hoop and motif size

- ▶ the attached hoop moves vertically (lengthwise), to be read by the computer
 - ▶ the motif size is traveled by the four arrow icons
- In a design combination, the stitching area of the combination and each individual design may be checked.
- select desired motif within a combination
 - touch «Back»-icon 2x
 - ▶ the «Edit»-display appears
 - ▶ the attached hoop is shown in the Display as well as in the «Select hoop»-icon
 - ▶ if no hoop or a too small hoop was attached, an error message will appear

Overview Embroidery menu

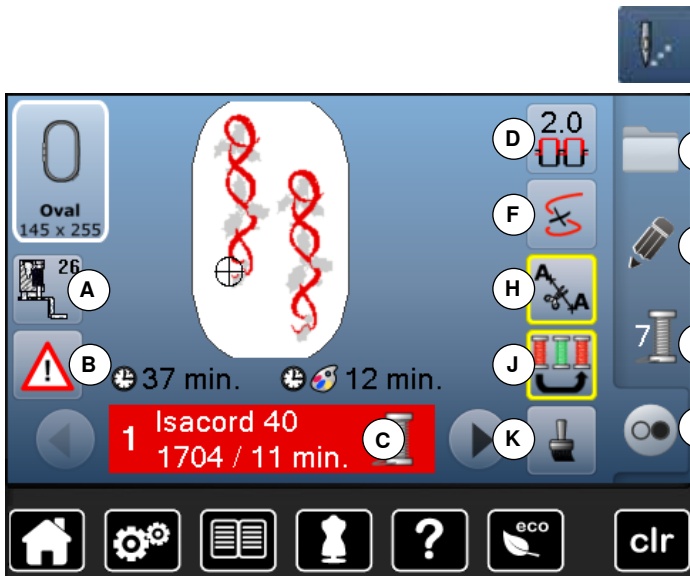

- press «Embroidery menu »-button

With some functions the instruction to use the knobs appears.

Functions

- A Presser foot indicator
- B Security program
- C Color information bar
- D Upper thread tension
- E Selection
- F Thread breakage
- G Edit
- H Disengage jump stitches
- I Color numbers
- J Embroidering motifs according to color sequence/Reducing color changes
- K Single/Multi-Color motif
- L «Embroidery menu»/«Start/Stop»-button

General Functions



Information

- touch the button
- ▶ another Display is opened



Back

- touch the icon
- ▶ goes back to the previous Display
- ▶ any alterations are accepted



Confirm selection

- touch the button
- Alteration/Selection is activated or confirmed.



Leaving the active Display

- touch the button
- ▶ the Display is closed
- ▶ the previous Display appears



Presser foot indicator

Embroidery foot No. 26 is displayed by default.

- touch the button
- ▶ further presser feet, such as e.g. free motion couching foot No. 43, are displayed and can be selected
- attach and select the appropriate presser foot for the project



Color information bar

Information about the active color.

- touch arrow icons right/left
- ▶ the current color is changed
- ▶ the hoop moves to the first stitch of the current color

The active color can also be embroidered individually.



Upper thread tension

Altering Upper thread tension.

- ▶ the respective value is visible in the icon



Selection

- select new motif
- add motif
- save motifs
- delete motifs



Security Program

- touch the button
- touch desired «Needle»- and/or «Stitch plate»-icon
- ▶ if the «Security»-icon is yellow-framed, the correct stitch plate is not attached or selected



Thread breakage

In the left Display the motif is shown in the normal size. In the right Display the motif is enlarged.



Edit

In this Display the motif can be edited.



Disengage jump stitches

By default the function is active (yellow-frame). Jump stitches are automatically cut.

- touch the button
- jump stitches must be trimmed manually



Color numbers

Display of the motif color numbers.

- touch the button
- ▶ Display providing the color information to the selected motif is opened



Embroidering the motif by color

With the icon deactivated, the number and sequence of colors remain as initially set.



Reducing color change

With the icon activated, the motif sections with identical colors are resequenced and color changes reduced.



Single/Multi-Color Motif

If the icon is active, the entire motif will be embroidered in one color (without stopping).

If the icon is inactive, the colors will be embroidered individually.



«Embroidery menu»/«Start/Stop»-button

The alternating blinking symbols indicate that:

- ▶ the embroidery Display is opened
- ▶ the embroidery computer is ready to embroider



The embroidery computer must be started by pressing the «Start/Stop»-button on the headframe.

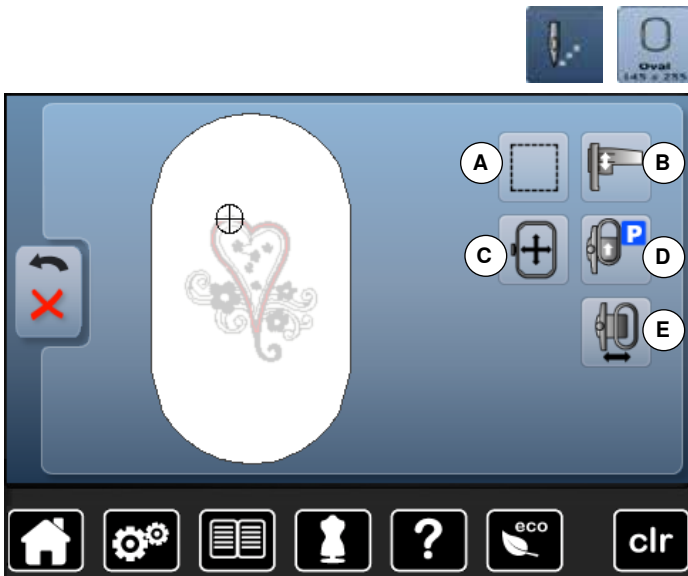

With some functions the instruction to use the knobs appears.

Functions

- A Basting Box
- B Calibrating the embroidery module
- C Moving hoop by using the knobs
- D Moving Hoop to Back
- E Embroidery hoop movement

General Functions



Information

- touch the button
- ▶ another Display is opened



Back

- touch the button
- ▶ Back to the previous Display
- ▶ any alterations are accepted



Confirm Selection

- touch the button
- Alteration/Selection is activated or confirmed.



Leaving the active Display

- touch the button
- ▶ the Display is closed
- ▶ the previous Display appears



Basting Box

- touch the button
- ▶ the embroidery motif is outlined with a straight stitch
- touch icon again, the symbol changes
- ▶ the basting is now done along the hoop
- touch the icon again
- ▶ Basting box function is switched off



The function will remain active even after selection of a new motif.



Calibrating the embroidery module

- touch the button
- ▶ the module is calibrated (reads the reference points)

No embroidery hoop must be attached!



Moving the hoop

If the fabric has to be re-hooped when stitching a large embroidery motif (e.g. lettering, borders etc.), the hoop has to be moved to the last stitch of the already embroidered part with the stitch width and stitch length knob.

- ▶ the movement is displayed in the icons



Move hoop to back

- ▶ the hoop moves vertically to the far back
- Better access for changing the bobbin.



Embroidery hoop movement

- ▶ the hoop moves horizontally to the center
- touch **X**
- press «Start/Stop»-button
- ▶ the hoop moves back to the previous position

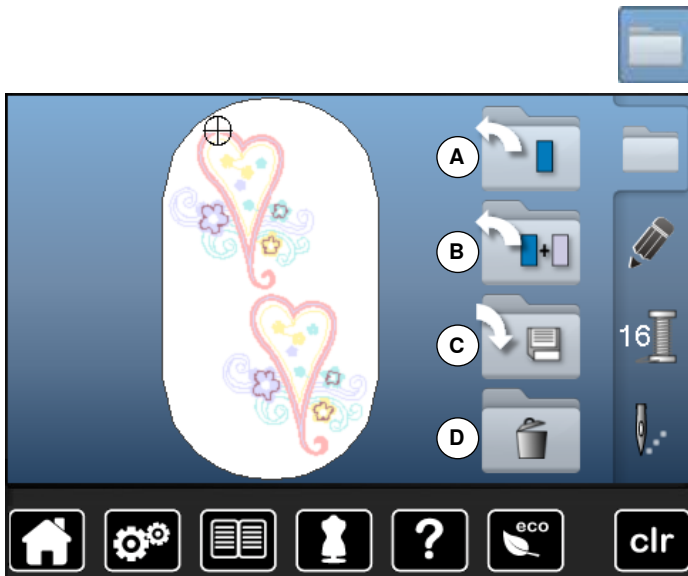

- press «Selection»-button

Functions

- A** New motif
- B** Add motif
- C** Saving motif
- D** Deleting motif



New Motif

- ▶ the overview of the previous Display is opened (Alphabet, Motifs, My Designs)
- select the desired motif



Add Motif

- ▶ the overview of the previous Display is opened (Alphabet, Motifs, My Designs)
- select the desired motif



Saving Motif

- ▶ the save Display is opened



Deleting Motif

- ▶ the delete Display is opened



■ press «Color number»-button

General Functions



Back

- touch the button
- ▶ goes back to the previous Display
- ▶ any changes/alterationen are accepted



Leaving active Display

- touch the button
- ▶ the Display is closed
- ▶ the previous Display appears



Changing the thread brand

- ▶ the Display showing different thread brands is opened

Selecting an embroidery motif



Various embroidery motifs from the «Alphabets», «Motifs» and «My Designs» files can be selected.

Alphabets



Selecting alphabet

- touch «Alphabet»-icon
- ▶ the various alphabet types are visible in the Display
- touch the desired «Alphabet»-icon



Entering/Correcting lettering

- ▶ the Display showing the keyboard is opened
 - the «ABC»-icon (upper case) is active automatically
 - select desired lettering
- The space bar is at the bottom of the letter keys.
- ▶ letters appear in the text bar
 - touch text bar 1
 - ▶ all entered text is deleted



Corrections

- touch the icon 2
- ▶ the entered text is deleted from right to left



- 3 «ABC» all in upper case characters (standard)
- 4 «abc» all in lower case characters
- 5 «Ä Å Á», «ä à á» and «@ #» upper and lower special characters
- 6 «1,2,3» numbers and mathematical character



If all the lettering cannot be displayed in the hoop, rotate the lettering by 90°. There is then more room for the lettering in the entire length of the embroidery hoop.
If this does not help, decrease the lettering size or reduce the number of letters.

BERNINA motifs

All BERNINA embroidery motifs can either be embroidered as-is, or changed and combined using the various functions offered by the embroidery computer.

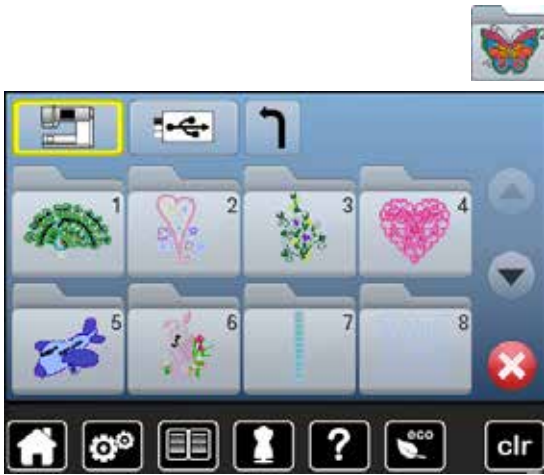

- touch «Motif»-icon

Motif overview

The motifs are displayed in folders according to topics.

- select folder
- select desired motif

My Designs

All embroidery designs can either be embroidered as-is, or changed and combined using the various functions offered by the embroidery computer.



- touch «My Design»-icon

Motif Overview

- select the desired motif touching the icon or via «0-9»-icon

Motifs in combination with functions

To activate the functions touch the appropriate icon and make alterations with the stitch width and stitch length knobs.

Move motif

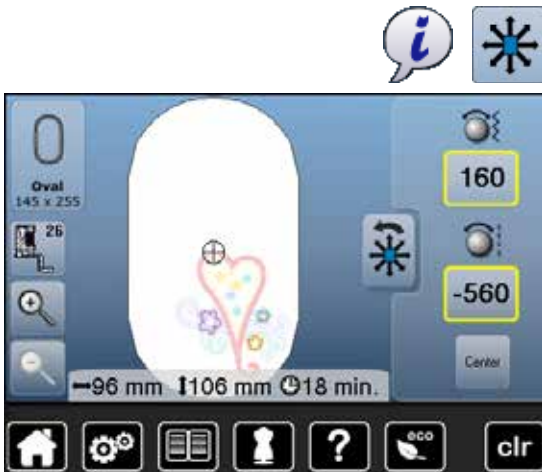

- touch «i»-icon
- touch «Move motif»-icon
- turn stitch width knob
 - ▶ the motif is moved horizontally
- turn stitch length knob
 - ▶ the motif is moved vertically
- ▶ the alteration is displayed in the icons in 1/10mm
- touch both stitch width and stitch length knob
 - ▶ if both icons display the same number, the motif has been moved diagonally
- touch the yellow-framed icon or the «Center»-icon
 - ▶ the motif is repositioned to the center of the hoop

Enlarging or reducing motif proportionally



- touch «i»-icon
- touch «Enlarging or reducing motif proportionally»-icon
- turn stitch width knob to the right
 - ▶ the motif is enlarged
- turn stitch width knob to the left
 - ▶ the motif is reduced
- ▶ the alteration is displayed in the icon in percent (%)
- touch yellow-framed icon
 - ▶ the size of the motif is reset to basic setting

Rotate motif



- touch «i»-icon
- touch «Rotate motif»-icon
- turn stitch width knob to the right
 - ▶ the motif rotates to the right
- turn stitch width knob to the left
 - ▶ the motif rotates to the left
- ▶ the position is displayed in the icon in degrees (°)
- touch yellow-framed icon
 - ▶ the position of the motif is reset to basic setting (0°/360°)
- touch «+90»-icon 1-4x
 - ▶ the motif rotates in 90°-steps (0°, 90°, 180°, 270°, 360°)

Mirroring motifs

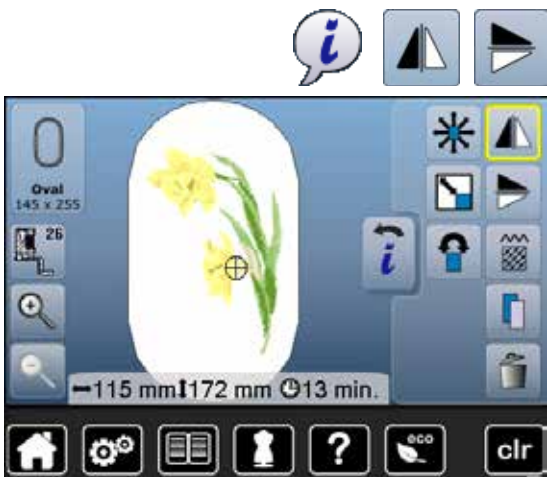

- touch «i»-icon
- touch «Mirror image left/right»-icon
- ▶ the motif will be mirrored horizontally
- touch «Mirror image up/down»-icon
- ▶ the motif will be mirrored vertically

Motif Center



- touch «Select hoop»-icon
- touch «Motif center»-icon
- ▶ center of motif is shown in the the Display 1
- ▶ the hoop is moved until the needle is exactly in the center of the motif
- touch the icon again
- ▶ the first stitch of the motif will be marked again in the Display

Grid

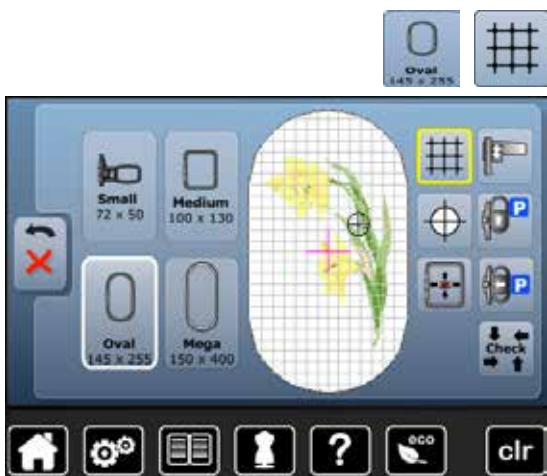

- touch «Select hoop»-icon
- touch «Grid»-icon
- ▶ a big cursor indicates the center of the hoop
- touch the icon again
- ▶ with the grid visible, it is easy to position the motif accurately
- touch the icon again
- ▶ the grid disappears

Absolute embroidery check

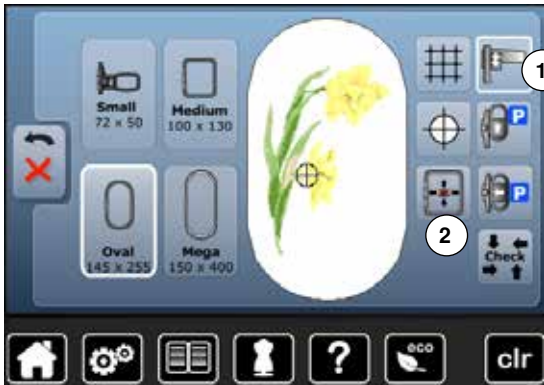

By using the touch pen any position within the motif can be selected directly in the «Edit»-Display.

- select and edit motif
- calibrate module if necessary **1**, see page 128
- attach the respective hoop

The «Motif center» icon must be deactivated in order to utilize Absolute check.

- check the embroidery motif within the hoop using the touch screen pen in the «Edit»-Display
- select any point in the motif with the touch pen
 - ▶ the cursor (marking the needle position) moves to the selected area
 - ▶ if the icon «Virtual positioning» **2** is activated (yellow-framed), the hoop is moved to position the needle over the selected area
- the icon «Virtual Positioning» appears only after the hoop has been read by the «Check»-function (touch «Check»-icon)



If the thread breaks, the touch pen can also be placed on the area of the Display where the thread broke. The hoop moves to that area.



- touch «Select hoop»-icon
- touch «Check»-icon
- ▶ the hoop size is read = the hoop moves



Checking the motif size

The «Check»-function reads the attached hoop size and stitching area:

- select the four corners using the arrow icons
- touch «Motif center»-icon
 - ▶ the needle moves to the center position of the motif
- touch «Back»-icon
 - ▶ the Display is closed
 - ▶ if no hoop or a too small hoop was attached, an error message will appear

Select Hoop



- select «Select hoop»-icon

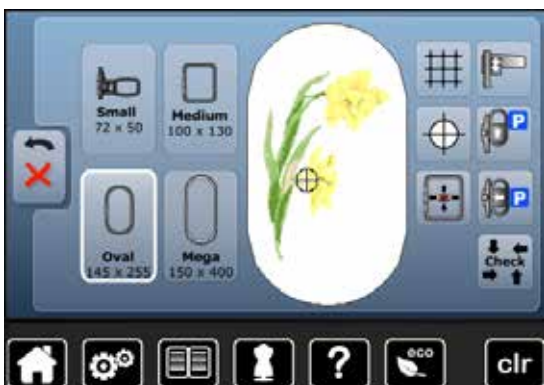

For best embroidery results always use the smallest hoop possible for the motif.

- select desired hoop
 - ▶ the selected hoop is highlighted in white
- touch «Back»-icon
 - ▶ the Display is closed
 - ▶ the motif appears in the desired hoop

Zoom



- touch «i»-icon
- touch «Zoom+»-icon 1-5x
- ▶ the motif image is enlarged by one step



- touch «Zoom-»-icon 1-5x
- ▶ the enlarged motif image is rescaled by one step

Moving the enlarged Motif



- touch «Move»-icon



Icon inactive:

- the motif can be moved to any position **within** the hoop directly in the Display by using the touch pen or the finger

Icon active (yellow-framed):

- the motif can be moved to any position **along with** the hoop directly in the Display by using the touch pen or the finger

Motif size and embroidery time



- touch «i»-icon

←96 mm ↓106 mm ⌚18 min.

Width and height of the embroidery motif is displayed in millimeters (mm). The embroidery time is displayed in minutes.

Combinations

Creating combinations



- select the desired motif from the selection menu of the embroidery computer

▶ the motif 1 appears in the «Edit»-display

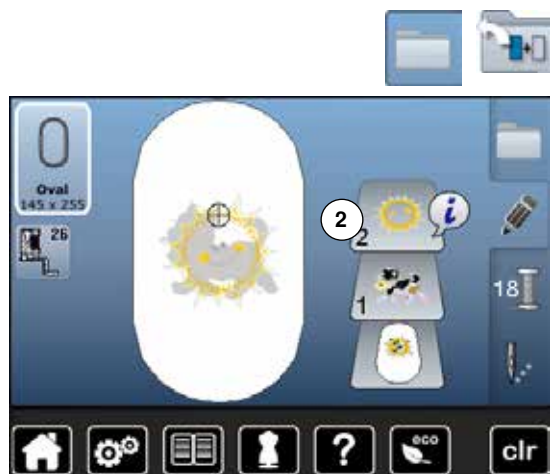

Adding Motif

- press «Selection»-button
- touch «Add motif»-icon
- select the desired motif or alphabet character from the selection menu
- ▶ the selected motif 2 is added



Duplicating a motif

- touch «i»-icon
- touch «Duplicate motif»-icon
- ▶ the active motif 1 is duplicated 2



Duplicating a combination

- activate a combination **1**
- touch «i»-icon
- touch «Duplicate motif»-icon
- ▶ the active combination **2+3** is duplicated **4**

Within in a duplicated combination the single motifs cannot be selected individually, contrary to the initial combination.

Lettering

Lettering (e.g. words) can be combined with other alphabet characters or motifs. The individual words (e.g. Made to create) are individually combined by the line and positioned individually.



Combining

- touch «Alphabet»-icon
- ▶ the various alphabets appear in the Display
- select desired «Alphabet»-icon
- ▶ the Display with the keyboard is opened
- e.g. enter Made to
- Select characters using the Lower/Upper Case icon.
- place the space with the bar under the keyboard
- confirm combined lettering with ✓
- ▶ lettering appears in the «Edit»-display



Positioning

- touch «Select hoop»-icon
 - select medium hoop
 - touch «Back»-icon
 - touch «i»-icon
 - touch «Rotate motif»-icon
 - touch «+90»-icon
 - ▶ the text is rotated by 90°
 - ▶ touch «Back»-icon
 - touch «Move motif»-icon
 - position the text in the Display using the knobs, the touch pen or the finger
- The outline of the hoop is highlighted in red if a stitch of the motif is positioned outside the embroidery area.

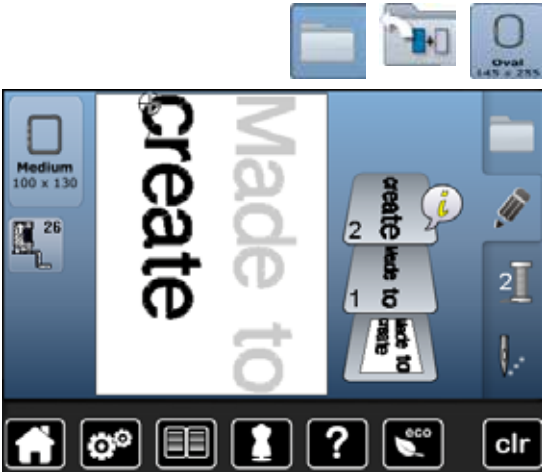

Further text lines

- press «Selection»-button
 - touch «Add motif»-icon
- Combine and position individually the rest of the text.
- touch «Select hoop»-icon
 - activate the grid, see page 138
 - ▶ use the grid lines to easily and accurately position lines of text

Motifs and lettering



Depending on the application, the characters are added after an embroidery motif is selected or the characters are combined first and then added to the motif (e.g. embellished lettering).

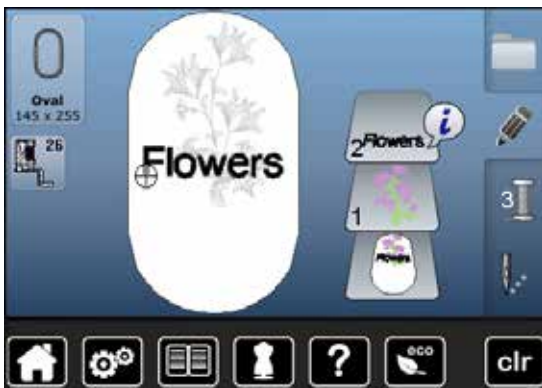

Combining

- select desired motif
 - ▶ the motif appears in the «Edit»-display
 - press «Selection»-button
 - touch «Add motif»-icon
 - touch yellow-framed «Embroidery computer»-icon
 - ▶ selection menu appears
 - select desired alphabet
 - ▶ display with the keyboard is opened
 - enter text, e.g. Flowers
- Select characters using the «Lower/Upper Case»-icon.
- confirm the combined lettering with ✓
 - ▶ the text appears above the motif in the «Edit»-display



Adjusting text to motif

- touch «i»-icon
- touch «Rescale motif»-icon
- adjust text to motif
- touch «Back»-icon
- touch «Move motif»-icon
- position the text as desired



Lettering Manipulation

- touch «i»-icon
- touch «Letter manipulation»-icon
- turn the stitch length knob to the left
- ▶ the text is bent downwards

Altering motif features



- touch «i»-icon
- touch «Alter motif features»-icon

To alter stitch type.
To alter the stitch density.



- touch «Alter stitch type»-icon
- ▶ the basic setting of the step stitch is activated



If the motif is enlarged substantially, long satin stitches occur. This can result in tunneling of the material. In this case, it is recommended to switch to a step stitch fill.

Fill stitch types

The embroidery motifs are filled with satin or step stitches.



Satin stitch

The needle swings from one side to the other.



Step stitch (fill stitch)

The needle stitches in straight rows at regular intervals.



- touch «Change stitch type»-icon



Change stitch type

The satin stitch fill changes to a maximum of 8mm long step stitches fill (basic setting).

- touch «+»/«-»-icon or turn stitch width knob to the left or to the right
 - ▶ maximum step stitch length is increased/decreased
- The maximum stitch length is 12.7mm and the minimum 0.5mm.

- ✓ touch the button
- ▶ chosen step stitch length is saved and the «Edit»-display appears

Back to basic setting

- touch yellow-framed icon
- ▶ the basic setting (8mm) is activated

Back to Satin stitch

- touch «Change stitch type»-icon again
- ▶ the motif is filled with satin stitches again

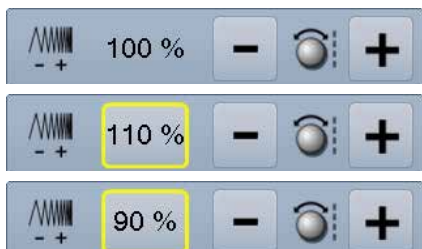

Altering Stitch Density

- touch «+»/«-»-icon or turn stitch length knob to the left or to the right
 - ▶ the stitch density is increased (more stitches)/decreased (less stitches)
- The maximum stitch density is 300% and the minimum 25%.

- ✓ touch the button
- ▶ chosen stitch density is saved and «Edit»-display appears

Back to basic setting

- touch yellow-framed icon
- ▶ the basic setting (100%) of the motif is activated again

Motif colors



Changing motif colors

- touch «Color number»-icon in the Display
- scroll with the arrow icons, if necessary, until the color to be changed appears
- select the color to be changed (e.g. 1)



- touch «Thread color»-icon
- scroll with the arrow icons until the desired color appears
- select the desired color or
- touch «0-9»-icon and
- enter the color number via the keyboard
- select color icon
- ▶ the new color is reallocated
- ▶ the altered color is displayed



Changing the thread brand

- touch «Thread color»-icon
- scroll with the arrow icons left or right until the desired thread brand appears
- touch «Thread brand»-icon
- ▶ the thread brand in the Display changes and the new thread details appear
- touch «Back»-icon
- ▶ the altered thread details are displayed



Different thread brands can be assigned to the motif.

- scroll to the desired thread brand
- do **not** touch icon
- scroll to the desired color
- touch the icon



Embroidering the motif by color

- press «Embroidery menu»-button
 - ▶ «Reduce color changes»-icon is inactive (standard, gray)
- The colors of a motif are not reduced, the embroidery sequence remains as set originally. The number of color changes **1** remains as it is.



Reducing color changes

- press «Embroidery menu»-button
 - touch «Reduce color changes»-icon
- Identical colors are resequenced and combined to form «color blocks». This reduces the number of color changes **2** to a minimum.



Embroidering motifs in one color

- press «Embroidery menu»-button
- touch «Single/Multi-Color Motif»-icon
- ▶ the function is activated
- ▶ the embroidery computer embroiders the complete motif and stops when finished



Embroidering lettering in multi colors

Lettering is always displayed in one color («Single/Multi-Color Motif»-icon is not available). To embroider each letter of a word or each word of a word combination in a different color, each letter or word must be programmed and placed separately.

- ▶ the embroidery computer stops after each letter or word
- the thread color can be changed
- ▶ the Embroidery time for each color is displayed

Embroidering lettering in one color

- touch the now available «Single/Multi-Color Motif»-icon
- ▶ the complete lettering combination is embroidered in one color



Basting box

- press the «Embroidery menu»-button
- touch the «Select hoop»-icon
- touch «Basting box»-icon

The embroidery motif is outlined with a straight stitch.

This serves as an additional anchoring of the project so that the fabric and stabilizer are adhered.



- touch the icon again
- ▶ the symbol changes

The basting is now done along the hoop.

- touch the icon again
- ▶ the basting is deactivated

This function remains active even if a new motif is selected.



Saving Motifs

Embroidery motifs from the embroidery computer, the USB stick, embroidery cards or designs created in the BERNINA Embroidery Software can be combined, re-arranged and altered in different ways, then saved. Embroidery motifs can either be saved in the embroidery computer memory or on a USB Stick.



In a saved stitch combination the individual stitch patterns can be altered after being selected. Embroidery motifs which were altered in size and saved are regarded as new motifs when they are recalled. That is why all percentages say 100%, and the former alteration can no longer be seen.

Embroidery computer memory

- select desired motif
- alter or combine if necessary
- press «Selection»-button
- touch «Save»-icon 1

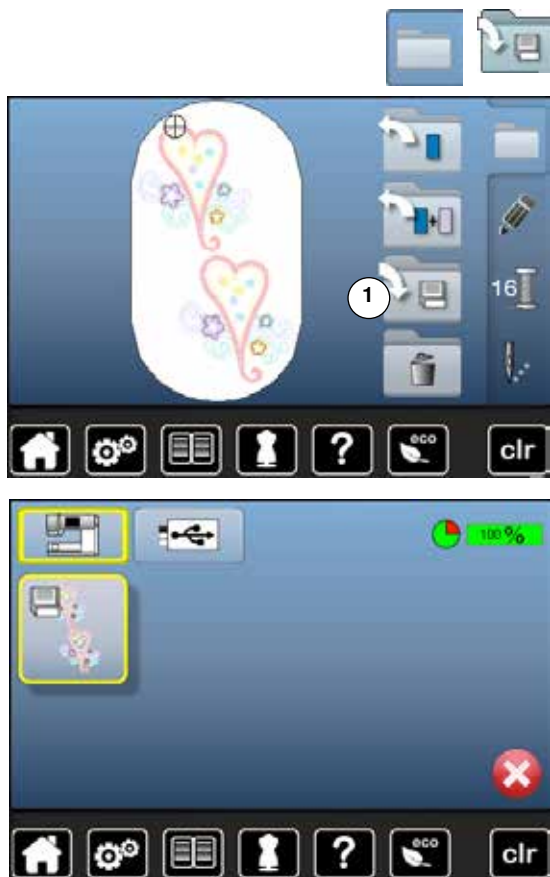

The motif to be saved is displayed in a yellow frame.

- ▶ «Embroidery computer»-icon is active
- ▶ the «My Designs» folder is opened automatically
- ▶ the system memory capacity (free capacity) is displayed in percent (%) in the green bar
- select the motif to be saved
- ▶ the embroidery motif is saved in numerical order in the «My Designs» folder
- ▶ the «Edit»-display appears again

USB stick



The motif to be saved is displayed in a yellow frame.

- insert USB-Stick
- touch «USB-Stick»-icon
 - ▶ the system memory capacity (free capacity) is shown in percentage (%) in the green bar
- select the motif to be saved
 - ▶ the motif is saved on the stick



Empty USB sticks are available as optional accessory at the BERNINA-dealer.

USB sticks produced by any other manufacturers may not be supported; especially USB sticks with large storage capacity.

Overwriting motifs

Saved motifs in the memory or on an USB Stick can be overwritten directly by another motif.

- select desired motif



- insert BERNINA USB-Stick
- press «Selection»-button
- touch «Save»-icon



The motif to be saved is displayed in a yellow frame.

- touch «Embroidery computer»-icon or «USB-Stick»-icon
- select the motif to be overwritten



- confirm with ✓
- ▶ the motif is now saved at the previously selected position

Deleting saved single motif

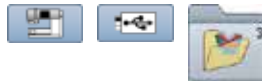

- insert USB-Stick
- touch «USB-Stick»-icon or
- touch «Embroidery computer»-icon or
- touch «My Design»-icon



- touch «Delete»-icon 1



- select the motif to be deleted



- confirm with ✓
- ▶ the motif is deleted

Cancelling deleting

- touch ✗
- ▶ the deleting is cancelled, the previous screen appears

Deleting all saved motifs

It is possible to delete the content of the folder «My Designs» or the USB stick all at once.



- press «Setup»-button
- touch «Basic settings»-icon
- touch «Delete user data»-icon



When embroidering there are two options to choose from:

- 1 My Designs
 - 2 USB stick (the stick must be inserted)
- touch the button of which the data should be deleted



- confirm with ✓
- ▶ the data is deleted

Cancelling deleting

- touch ✗
- ▶ the deleting is cancelled, the previous screen appears

Starting to embroider

Select hoop



- select motif
 - ▶ the selected motif is displayed in the optimal (the smallest) hoop
 - ▶ the «Select hoop»-icon displays the recommended hoop
- attach the recommended hoop

Attaching the embroidery hoop

- raise needle and embroidery foot
- hold the hoop with the right side of the fabric up and the attaching mechanism to the left

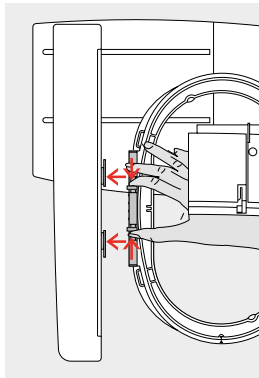

Attach the hoop to the embroidery arm

- guide the hoop underneath the embroidery foot
- press the attaching mechanisms of the hoop toward each other
- position the center points of the hoop (small attachment clamps) over the bracket of the embroidery arm
- press down until it clicks in position
- release the attaching mechanism of the hoop

Removing the hoop

- press both of the attaching mechanisms of the hoop toward each other
- lift the hoop up to remove



- press «Embroidery menu»-button or «Start/Stop»-button on the headframe
 - ▶ the hoop moves
 - ▶ the hoop is read



As soon the «Embroidery menu»-button has been pressed, made alterationen will not be visible anymore when going back to the «Edit»-display. The «Information»-icon turns blue again, the function icons are no longer yellow-framed and the setting is at 100%.

Embroidery menu



- ▶ embroidery menu is opened
- ▶ the motif is ready for embroidering

Embroidering using the «Start/Stop»-button on the headframe



- press the «Start/Stop»-button on the headframe, until the embroidery computer starts
- ▶ the embroidery computer sews approximately 7 stitches and stops automatically
- ▶ a Display indicates that the thread tail has to be cut at the beginning of the motif
- raise the presser foot
- cut the thread tail at the beginning of motif
- lower the presser foot
- press the «Start/Stop»-button on the headframe and continue embroidering

Interrupting the process

- press «Start/Stop»-button on the headframe
- ▶ the embroidery computer stops

Completing the color

- press «Start/Stop»-button on the headframe
- ▶ the embroidery computer embroiders all the sections in the color activated
- ▶ the embroidery computer stops automatically when complete
- ▶ both threads are automatically cut

Changing color

- ▶ the embroidery computer switches automatically to the next color
- change color of the upper thread accordingly
- embroider with the new color



Embroidering Display

- ▶ after starting the motif the embroidering Display appears

Embroidering with foot control

When embroidering with the foot control always keep it depressed.

- press the foot control
- ▶ the embroidery computer sews approximately 7 stitches and stops automatically
- ▶ a Display indicates that the thread end has to be cut after the start of embroidering
- release the foot control
- raise the presser foot
- cut the thread tail at the beginning of motif
- lower the presser foot
- ▶ press the foot control and continue embroidering

Interrupting with the foot control

- release the foot control
- ▶ the sewing computer stops

Completing the color

- press the foot control
- ▶ the embroidery computer embroiders all the sections in the color activated
- ▶ the embroidery computer stops automatically when complete
- ▶ both threads are automatically cut

Changing color

- ▶ the embroidery computer switches automatically to the next color
- change color of the upper thread accordingly
- embroider with the new color



Embroidering display

- ▶ after starting the motif the embroidering display appears

Thread breakage when embroidering

The upper or lower thread may occasionally run out or break when you are embroidering. When this happens, the embroidery computer stops automatically, provided that the thread and bobbin indicators are activated in the setup program.

Upper or lower thread breaks



- ▶ the embroidery computer stops automatically
- ▶ an animation is displayed
- check upper thread
- rethread needle
- check lower thread
- refill or rethread bobbin

Embroidery sequence control when thread breaks



- touch «Thread breakage»-icon



In the left portion of the Display the motif is shown in original size and in the right portion enlarged. This makes it easier to check the embroidery sequence.

- ▶ the message to operate the stitch width and stitch length knobs appears
- turn the knobs to the left or to the right
- ▶ the hoop moves along the embroidery sequence backwards or forwards
- turn the stitch width knob slowly
- ▶ the hoop is moved stitch by stitch
- turn the stitch length knob slowly
- ▶ the hoop is moved in big steps
- ▶ the number in the yellow-framed icon indicates the current position within the motif by stitch number
- via the «0-9»-icon a position can be entered directly
- position the needle back far enough so that it will resume stitching several stitches before the thread breakage

Returning to original position

- touch «Back»-icon
- ▶ the Display is closed

Resuming embroidering

- press «Start/Stop»-button or the foot control



Cleaning

ATTENTION!

Disconnect plug from the socket before cleaning or lubricating!
Never use alcohol, petrol, white spirit or any type of solvent to clean the sewing computer!



Cleaning the Display and the sewing computer

Wipe with a soft, damp cloth.

Feed dog area

Clean the sewing computer after every use - remove any lint from under the stitch plate and in the hook area.

- turn power switch to «0» (off)
- remove plug from electrical outlet
- remove presser foot and needle
- open the bobbin door
- press the stitch plate down at the right back corner until it flips up
- remove the stitch plate
- clean the area with the lint brush
- replace the stitch plate



Cleaning the hook

- turn power switch to «0» (off)
- remove plug from electrical outlet
- remove bobbin case
- clean the hook race with a lint brush, do not use sharp instruments for cleaning
- insert the bobbin case



Lubricating

- turn power switch to «0» (off)
- remove plug from electrical outlet
- squeeze 1 or 2 drops of BERNINA oil into the hook race
- turn power switch to «I» (on)
- run the sewing computer for a short time (without thread)
- ▶ so sewing project is not soiled





Troubleshooting



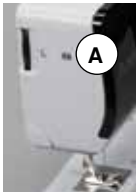





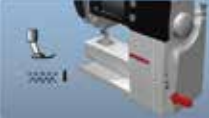

In most cases you will be able to identify and remedy faults by checking the following.

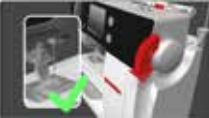







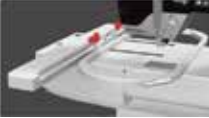

Check if:

- the upper and lower threads are threaded correctly
- the needle is inserted correctly
- the needle size is correct - check the needle/thread table page 24
- the needle tip and shaft are undamaged
- the sewing computer is clean - brush out any thread lint
- the hook race is clean
- any threads are trapped between the tension discs or under the bobbin case spring

Fault	Cause	Repair
Uneven stitch formation	<ul style="list-style-type: none"> – Upper thread too tight/too slack – Needle blunt or bent – Poor quality needle – Poor quality thread – Needle/thread combination is incorrect – Incorrectly threaded 	<ul style="list-style-type: none"> ■ reduce/increase upper thread tension ■ use new BERNINA quality needle ■ use new BERNINA quality needle ■ use quality thread (Isacord, Mettler, Gütermann etc.) ■ match the needle to the thread size ■ check upper and lower thread
Skipped stitches	<ul style="list-style-type: none"> – Incorrect needle system – Needle bent or blunt – Poor quality needle – Needle inserted incorrectly – Incorrect needle point 	<ul style="list-style-type: none"> ■ use needle system 130/705H ■ use new BERNINA quality needle ■ use new BERNINA quality needle ■ insert needle as far up as it will go ■ match the needle point to the texture of the material
Faulty stitching	<ul style="list-style-type: none"> – Remnants of thread between the tension discs – Incorrectly threaded – Remnants of thread under the bobbin case spring 	<ul style="list-style-type: none"> ■ fold a piece of thin material and slide the folded edge (not the raw edges) between the thread tension discs, moving the material back and forth to clean the right and left side of the thread tension ■ check upper and lower thread ■ carefully remove any thread remnants from under the spring
Thread is caught in the area of the take-up lever	<ul style="list-style-type: none"> – Upper thread breaks 	<p>If the upper thread breaks and the thread is trapped in the area of the take-up lever, proceed as follows:</p> <ul style="list-style-type: none"> ■ turn power switch to «0» (off) ■ remove the screw A on the headframe with the angular Torx wrench ■ turn headframe cover slightly to the left, then slide it upwards and remove ■ remove remnants of thread ■ attach headframe and retighten screw
Upper thread breaks	<ul style="list-style-type: none"> – Upper thread tension too tight – Incorrectly threaded – Poor-quality or old thread – Stitch plate or hook tip damaged 	<ul style="list-style-type: none"> ■ reduce upper thread tension ■ check upper threading ■ use quality thread (Isacord, Mettler, Gütermann etc.) ■ take the sewing computer to the nearest authorized BERNINA dealer
Lower thread breaks	<ul style="list-style-type: none"> – Lower thread tension too tight – Stitch hole in the stitch plate has been damaged – Needle blunt or bent 	<ul style="list-style-type: none"> ■ increase the upper thread tension ■ take the sewing computer to the nearest authorized BERNINA dealer ■ use new needle
Needle breaks	<ul style="list-style-type: none"> – Needle not correctly inserted – Fabric was pulled – Fabric was pushed when using thick material – Poor-quality thread, unevenly wound or knotted 	<ul style="list-style-type: none"> ■ tighten the needle clamp screw ■ do not pull the fabric during sewing ■ use the correct presser foot for thick material (e.g. Jeans foot No. 8) use height compensating tool when sewing over a thick seam ■ use quality thread (Isacord, Mettler, Gütermann etc.)

Fault	Cause	Repair
Stitch width not adjustable	<ul style="list-style-type: none"> – Setting activated in the security program 	<ul style="list-style-type: none"> ■ deactivate setting
Display is inactive	<ul style="list-style-type: none"> – Calibration data incorrect – ECO-function active 	<ul style="list-style-type: none"> ■ re-calibrate the Display in the Setup Program ■ turn off ECO function
Sewing-/Embroidery computer	<ul style="list-style-type: none"> – Sewing computer fails to run or runs slowly – Turn power switch to «0» (off) 	<ul style="list-style-type: none"> ■ alter the speed control ■ place the sewing computer in a warm room one hour before use ■ turn the power switch to «I» (on) ■ take the sewing computer to the nearest authorized BERNINA dealer
Upper thread indicator does not respond	<ul style="list-style-type: none"> – Not activated in the Setup Program 	<ul style="list-style-type: none"> ■ activate in the Setup Program
Lower thread indicator does not respond	<ul style="list-style-type: none"> – Not activated in the Setup Program 	<ul style="list-style-type: none"> ■ activate in the Setup Program
Lower thread indicator reacts	<ul style="list-style-type: none"> – Thread used/broken – Bobbin inserted incorrectly – Brake spring is missing 	<ul style="list-style-type: none"> ■ wind thread and thread ■ insert bobbin correctly ■ insert brake spring into bobbin case
Update error	<ul style="list-style-type: none"> – USB stick is not recognized – Update process is blocked (hourglass stays on display) – Update-data aren't identified 	<ul style="list-style-type: none"> ■ use a BERNINA USB stick ■ remove the stick and turn the sewing computer off and on again. Proceed with the update as indicated by the message ■ don't save update-data in a folder ■ unzip update-data
LED sewing light do not light up	<ul style="list-style-type: none"> – LED defective – deactivated in the Setup Program 	<ul style="list-style-type: none"> ■ take the sewing-/embroidery computer to the nearest authorized BERNINA dealer ■ activate in the Setup Program
General	Explanation	Repair Messages
Sewing-/Embroidery computer 	<ul style="list-style-type: none"> – Deleting or overwriting data, e.g. drawers 	<ul style="list-style-type: none"> ■ confirm with ✓ or cancel with ✗
	<ul style="list-style-type: none"> – Stitch number not known in direct entry 	<ul style="list-style-type: none"> ■ check command entered and enter a new number
	<ul style="list-style-type: none"> – Stitch selection not possible in the combination mode 	<ul style="list-style-type: none"> ■ make another selection
	<ul style="list-style-type: none"> – Raise the presser foot 	<ul style="list-style-type: none"> ■ the presser foot is raised
	<ul style="list-style-type: none"> – Lower the presser foot 	<ul style="list-style-type: none"> ■ the presser foot is lowered

General	Explanation	Repair Messages
	– Lower feed dog	■ press the «Feed dog»-button. The feed dog is lowered
	– Incorrect needle for the stitch plate selected	■ check settings in securing program
	– Needle is not in the highest position	■ turn handwheel
	– Upper thread used up	■ attach new upper thread spool and thread
	– Lower thread indicator has reacted	■ check lower thread and wind if necessary
	– Main motor is not running	■ check hook system. Remove any thread lint from the hook area/bobbin case
	– Needle position doesn't correspond to center of hoop	– Adjust according to User Instructions page 43
		
	– Attaching the Module	■ position the module correctly to the sewing computer. Plug the cable in the outlet provided ■ an animation shows that embroidery software is loaded
		
	– No embroidery hoop attached	■ attach embroidery hoop
	– Embroidery hoop attached	■ remove embroidery hoop

General	Explanation	Repair Messages
	– Mega-Hoop up	■ move the Mega-Hoop to upper (1) position
	– Mega-Hoop center	■ move the Mega-Hoop to middle (2) position
	– Mega-Hoop down	■ move the Mega-Hoop to lower (3) position
	– Embroidery motif is partly outside the hoop	■ re-position the embroidery motif. The area within the hoop can be embroidered
	– Embroidery motif is too large	■ reduce the motif size or attach a bigger hoop. The area within the hoop can be embroidered
	– Less free space on the USB stick	■ delete data from USB stick
	– No personal data available on the USB stick	■ check that the USB stick is inserted correctly and re-start the sewing computer
	– During the update process personal data was not saved on the USB stick	■ the software was correctly updated. Personal data could not be recovered
	– BERNINA USB stick is not inserted	■ insert BERNINA USB stick and do not remove during the update process
	– New SW Version is not available on the stick	■ save the new SW Version on the BERNINA USB stick and start the update again

General

Explanation

Repair Messages

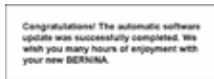

- Update successful

- the sewing-/embroidery computer has been provided with the latest software version

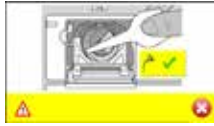

- The sewing computer must be cleaned/lubricated

- this notification will appear after approx. 180,000 stitches. After cleaning/oiling clear the Display by touching . The Display can be cleared temporarily by touching , but will appear again when restarting the sewing computer. After clearing with «ESC» for the third time, the cleaning notification will only appear again after a further approx. 180,000 stitches

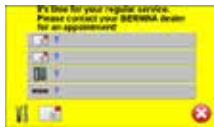

- It is time for the regular maintenance. Please contact your BERNINA dealer or your BERNINA service address

- the sewing-/embroidery computer must be taken to an authorised BERNINA dealer/servicing shop. The message appears after approx. 2,000,000 stitches. Once the servicing has been performed by an authorised BERNINA dealer/servicing shop, the stitch counter is reset to «0» (zero) and the message disappears. The message can be deleted temporarily by touching the field «ESC» but will reappear when the sewing-/embroidery computer is next restarted. After the third deletion with the message will not reappear until the next reminder at approx. 4,000,000 stitches (in total). Having your sewing/embroidery computer cleaned and serviced properly at the appropriate times ensures its proper functioning and long service life. Failure to do so may adversely affect service life and limit the guarantee. The charge for servicing is nationally regulated – consult your dealer or servicing shop for details

Practical stitches

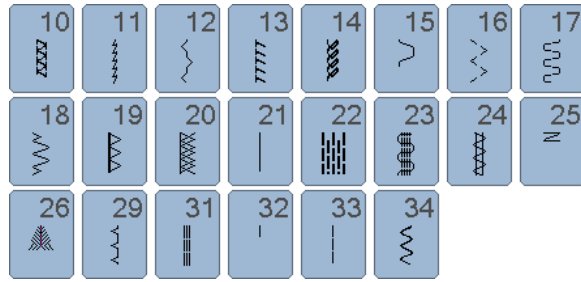
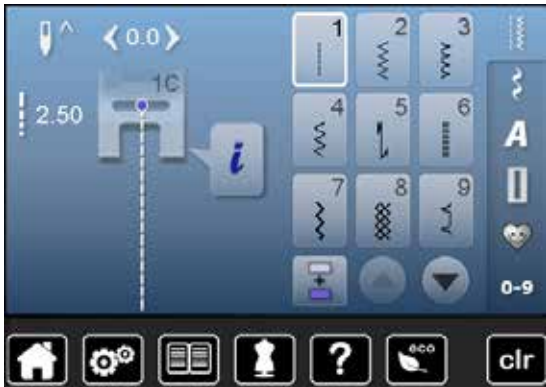

Buttonholes



Decorative stitches

Florals



Cross stitches



Satin stitches

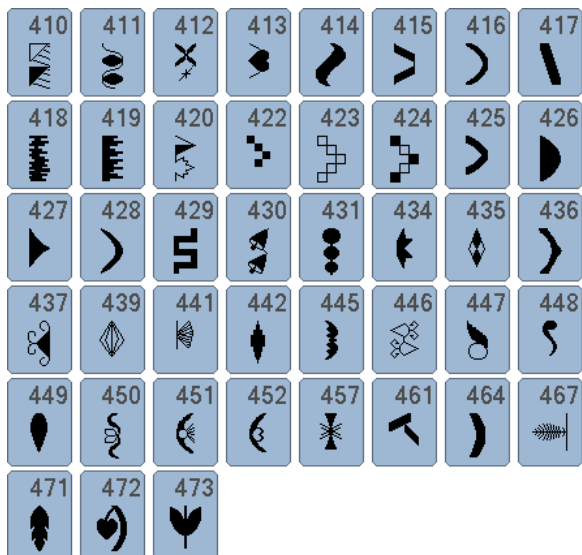

Ornamental stitches



Heirloom stitches

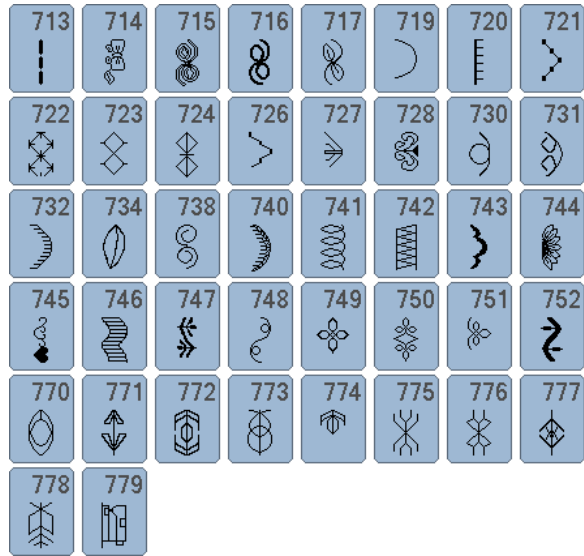

Novelty Stitches

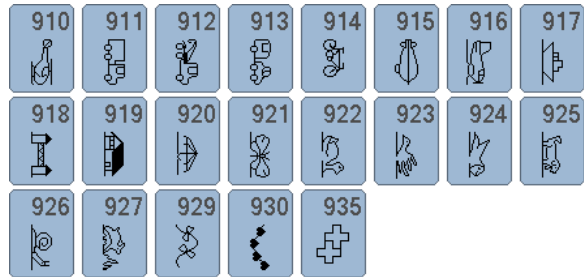

Quilt stitches



Alphabets
Block



P	Q	R	S	T	U	V	W
X	Y	Z	Ä	À	Â	Å	Æ
Ç	È	É	Ê	Ñ	Ö	Œ	Ø
Ü	1	2	3	4	5	6	7
8	9	0	-	-	.	'	!
+	=	&	÷	?	%	@	(
)	[]					



p	q	r	s	t	u	v	w
x	y	z	ä	à	â	å	æ
ç	è	é	ê	ñ	ö	œ	ø
ü							

Double-Block



P	Q	R	S	T	U	V	W
X	Y	Z	Ä	À	Â	Å	Æ
Ç	È	É	Ê	Ñ	Ö	Œ	Ø
Ü	1	2	3	4	5	6	7
8	9	0	-	-	.	'	!
+	=	&	÷	?	%	@	(
)	[]					



p	q	r	s	t	u	v	w
x	y	z	ä	à	â	å	æ
ç	è	é	ê	ñ	ö	œ	ø
ü							

Script



P	Q	R	S	T	U	V	W
X	Y	Z	À	Á	Â	Ã	Ä
Ç	È	É	Ê	Ë	Ï	Ö	Ø
Ù	1	2	3	4	5	6	7
8	9	0	-	-	.	'	!
+	=	&	÷	?	%	@	(
)	[]					



p	q	r	s	t	u	v	w
x	y	z	à	á	â	ã	ä
ç	è	é	ê	ë	ï	ö	ø
ù							

Hiragana



た	ち	つ	て	と	な	に	ぬ
ね	の	は	ひ	ふ	へ	ほ	ま
み	む	め	も	や	ゆ	よ	ら
り	る	れ	ろ	わ	を	ん	あ
い	う	え	お	ゃ	ゅ	ょ	っ
が	ぎ	ぐ	げ	ご	ざ	じ	ず
ぜ	ぞ	だ	ぢ	づ	で	ど	ば
び	ぶ	べ	ぼ	ぱ	ぴ	ぷ	ぺ
ぽ	1	2	3	4	5	6	7
8	9	0	-	_	.	?	!
・	,	「	」	『	』		

Katakana



タ	チ	ツ	テ	ト	ナ	ニ	ヌ
ネ	ノ	ハ	ヒ	フ	ヘ	ホ	マ
ミ	ム	メ	モ	ヤ	ユ	ヨ	ラ
リ	ル	レ	ロ	ワ	ヲ	ン	ァ
ィ	ゥ	ェ	ォ	ャ	ュ	ョ	ッ
ガ	ギ	グ	ゲ	ゴ	ザ	ジ	ズ
ゼ	ゾ	ダ	ヂ	ヅ	デ	ド	バ
ビ	ブ	ベ	ボ	パ	ピ	プ	ペ
ポ	1	2	3	4	5	6	7
8	9	0	-	_	.	?	!
・	,	「	」	『	』		

Kanji



才	組	保	育	幼	稚	園	小
中	学	校	月	火	水	木	金
土							

Cyrillic



О	П	Р	С	Т	У	Ф	Х
Ц	Ч	Ш	Щ	Ъ	Ы	Ь	Э
Ю	Я	Ө	Ғ	Қ	Ң	Ө	Ұ
Ү	Һ	І	Ҫ	Ј	Љ	Њ	Ћ
Џ	Ѓ	Є	Ї	Ў	È	Ѓ	Ѕ
Ќ	Ў						

Animals



BD195



95.3mm
137.9mm



CM211*

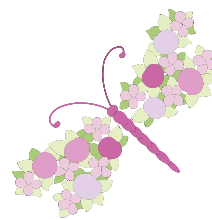

70.7mm
80.6mm

FQ394



98.6mm
98.3mm



FQ515



67.1mm
118.5mm



FQ600



116.9mm
112.6mm



LJ599



98.0mm
93.2mm



LJ600



98.2mm
95.7mm



WM783



124.1mm
109.1mm

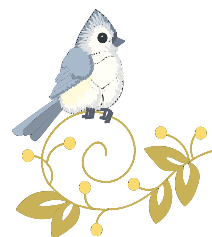

WP224







111.0mm
100.4mm



WS610



111.1mm
127.3mm

-  Free Standing Lace
-  Basic CutWork
-  Fringes
-  Application

* This design has special effects. For more information please go to www.bernina.com/5series

Embellishment

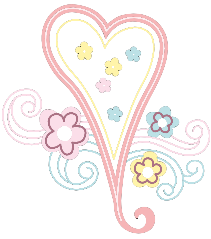

CM198*

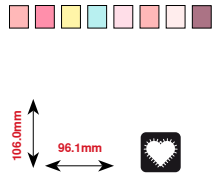

FB033

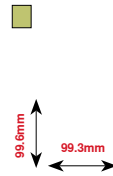

FB106

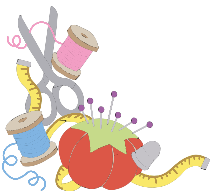
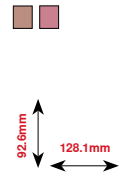

FB148

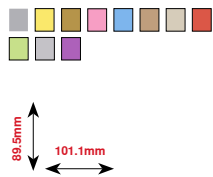

FB323

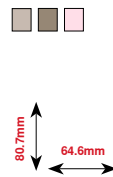

FB335

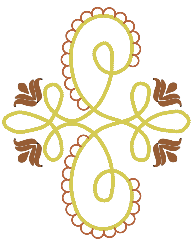

FB401

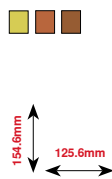

FQ227



NV720

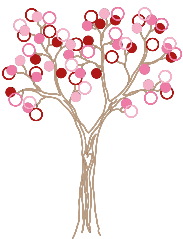
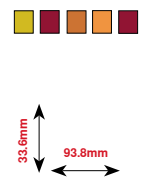

FQ871

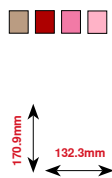

HE428

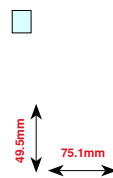

HG203



NA241

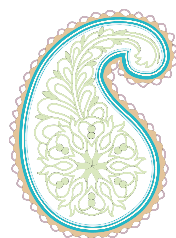
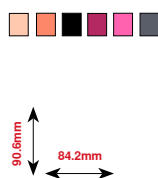

NA959*

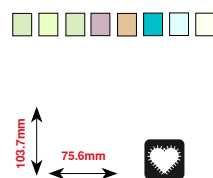

NB209

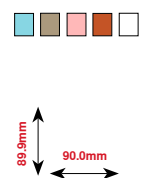

* This design has special effects. For more information please go to www.bernina.com/5series



NB385

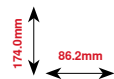

NB481

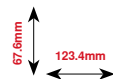

NB711

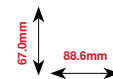

NB749

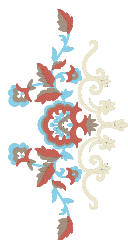
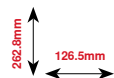

WS655

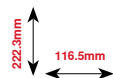

Floral

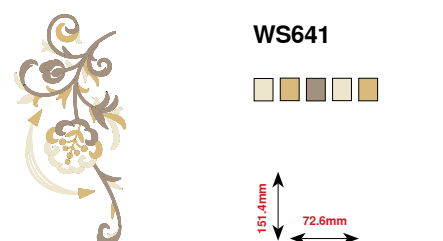
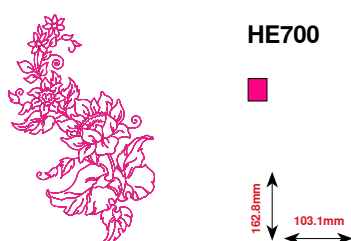
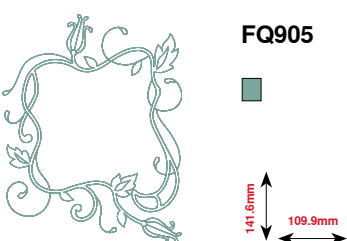
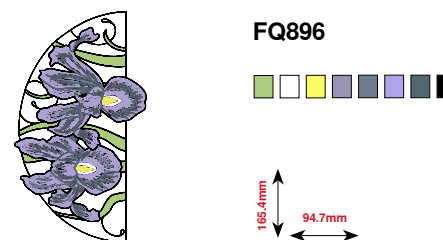
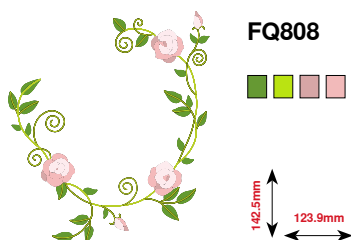
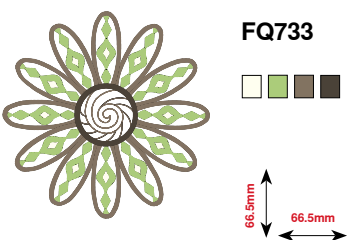
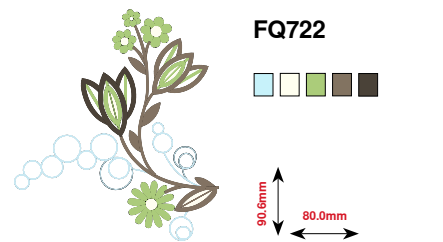
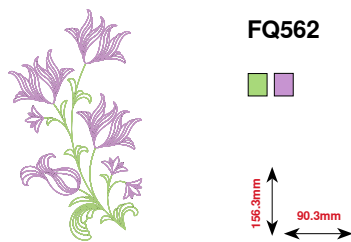
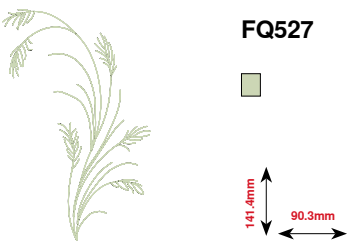
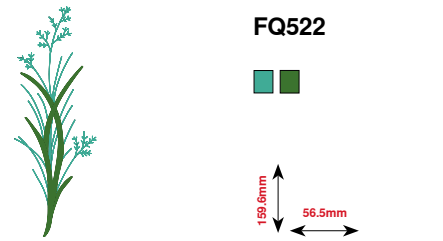
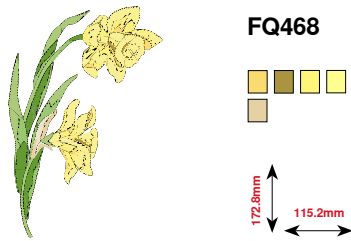
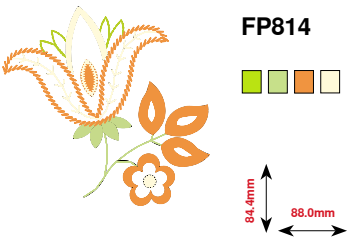
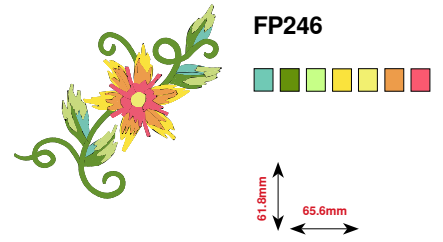
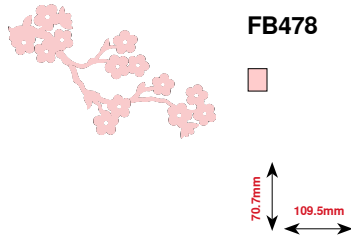
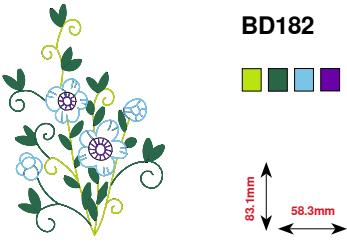

Lace

NX957

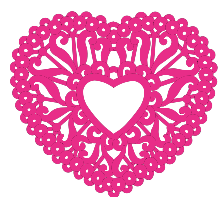

88.1mm
97.9mm

FB422*

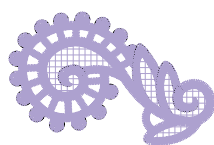

53.8mm
52.3mm



FB423*



53.8mm
132.9mm



FB461*



121.6mm
121.7mm



HG341

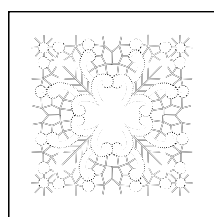

63.8mm
63.7mm

NB467

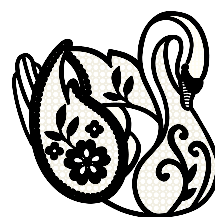

124.7mm
125.5mm

NX696



90.7mm
91.2mm

* This design has special effects. For more information please go to www.bernina.com/5series

Children

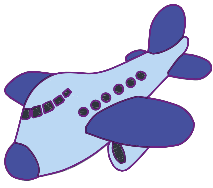

CK511

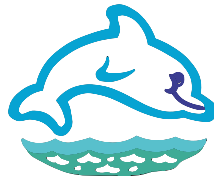
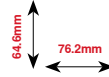

CK667*

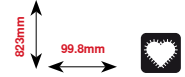

CK738

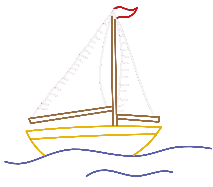
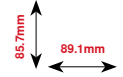

CM013

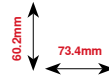

CM022

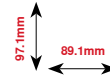
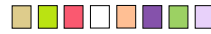

CM348

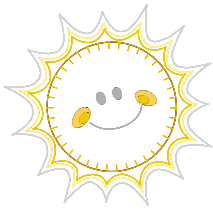
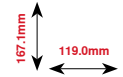

CM376*

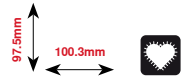

CM433

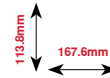

CM465

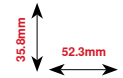

HE456

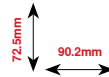

NA667

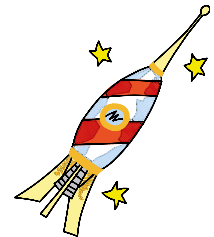
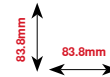

NB302

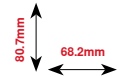

WP192

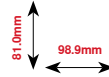

* This design has special effects. For more information please go to www.bernina.com/5series

Seasons



CM287



117.2mm
90.4mm



CM426



96.0mm
45.8mm



FQ748



130.9mm
80.8mm



HE543



84.2mm
73.4mm



HE563



129.5mm
63.3mm



HE900



115.7mm
110.3mm



HE969



79.3mm
84.9mm



HG177



158.6mm
50.0mm



HG317



92.8mm
79.5mm

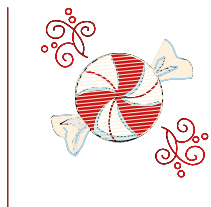

NA512



76.0mm
76.2mm

Borders



CM473



209.6mm
31.8mm



FQ559



28.6mm
136.4mm



FQ741



71.1mm
26.4mm



FQ810



206.4mm
23.6mm



HG455



298.6mm
137.0mm



NA909



19.8mm
100.4mm



NB520



175.9mm
26.3mm



NB651



141.0mm
30.7mm



RC768



28.9mm
85.5mm



FB436



29.2mm
132.8mm

Quilting

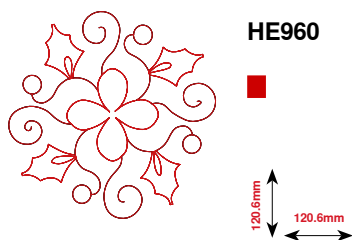
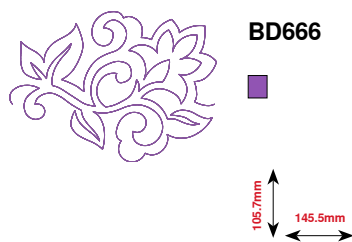
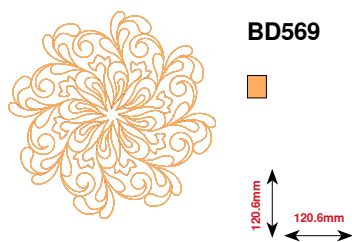
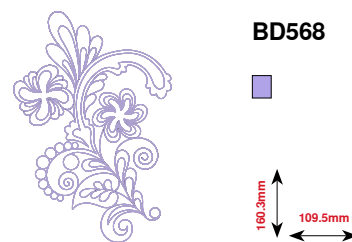
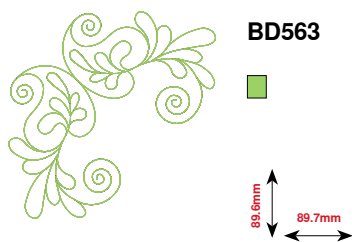
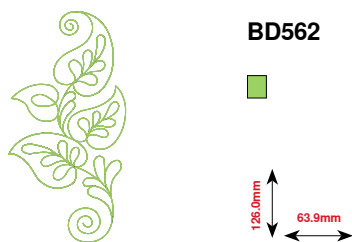
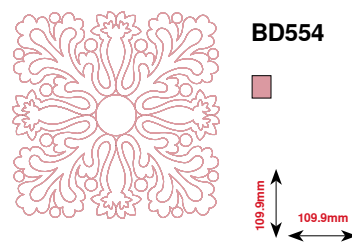
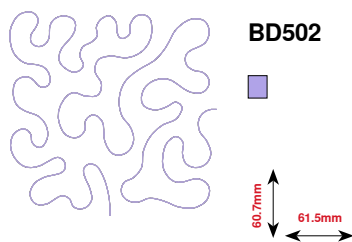
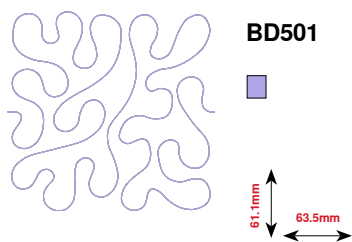

Sports

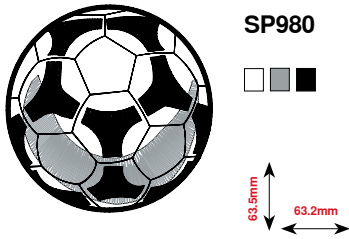
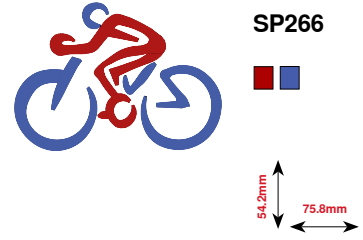
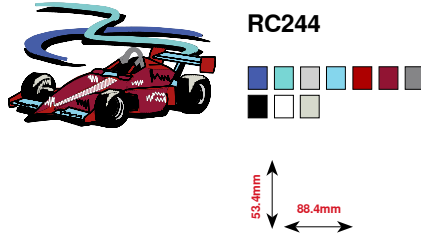
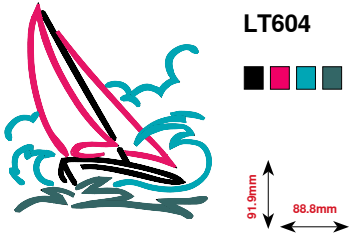

Alphabets

King Charles

ABC

Anniversary

Abc

Swiss Block

ABC

London

Abc

Chateau

Abc

Guinevere

Abc

Emerald

Abc

Index

A

Accessory

- Embroidery 112
- Presser feet 8
- Sewing 7-8
- Standard 7, 8
- Storage example 9

Accessory box 9

Adjusting

- Embroidery hoop 43
- Needle position 27, 60
- Presser foot pressure 21
- Upper thread tension 20

Air vents 11

Alphabets

- Altering letter size 101
- Combining lettering embroidery 142
- Combining lettering sewing 100
- Correcting the combination 100
- Correction 135
- Deleting lettering 100
- Functions 34, 35
- Kinds of alphabets 99
- Lettering 99
- Main display/Menu selection 28
- Multiline lettering 143
- Overview 99, 124
- Placing lettering 142
- Selecting 99, 135
- Upper-/lower case lettering 101
- With embroidery motifs 143-144
- With functions 101

Altering

- Audio systems 44
- Brightness 41
- Display settings 41
- Embroidery settings 43
- Sewing light 41
- Upper thread tension 42, 43, 130
- Welcoming text 41
- Winding speed 45

Altering embroidery settings 43

Altering pattern length 31

Altering stitch density 31

Altering stitch length 60

Altering stitch width 60

Altering stitch

- Length 60
- Width 60

Altering winding speed 45

Attaching

- Embroidery hoop 154
- Presser foot 18
- Presser foot lifter 13
- Seam guide 13
- Slide-on table 12
- Stitch plate 19

Audio System

- BSR 44
- Stitch pattern 44
- Altering 44
- Function 44

B

Back-icon 30, 32, 34, 36, 38, 39, 124, 126, 128, 130, 132, 134

Balance

- Back to basic setting 54
- Buttonhole 78
- Compensating/correcting 31, 33, 35, 37, 54
- Correcting 54
- Glossary 6
- Practical- and decorative stitches 54

Basic setting

- Embroidery settings 43
- Presser foot pressure 21
- Sewing settings 40, 42-43
- Thread tension 20

Basting stitch 57, 70

Bobbin case

- Inserting 15
- Removing 15

Bobbin cover 11

Bobbin winder pre-tension 11, 14

Brightness 41

BSR

- Attaching presser foot 94-98
- Beeper 95
- Display 97
- Functions 95
- Leaving 96
- Modes 98
- Preparation 94
- Removing/attaching presser foot sole 95
- Securing 96
- Starting 98
- With straight stitch No. 1 94
- With zigzag stitch No. 2 94, 98

Button sew-on program 74, 86

Buttonhole	74-87	Combination	36-39
■ 5-steps, manually	85	■ Combination repeat	39
■ 7-steps, manually	85	■ Combination subdivider (1)	38
■ Adjusting the bead width	75	■ Combination subdivider (2)	38
■ Altering stitch length	75	■ Deleting single stitch pattern	36
■ Automatic	79-82	■ Deleting the whole combination	39
■ Automatic buttonhole foot No. 3A	8, 46, 79, 81	■ Mirror image left/right	39
■ Automatic round and keyhole buttonhole	81	■ Securing	38
■ Balance	78	Compensating material	72, 75
■ Button sew-on program	74, 86	Compensation	
■ Cording	77	■ Height of seam	72
■ Cutting open	77	■ Layers	72
■ Duplicating	79	Connection	
■ Eylets	74, 87	■ BSR	11, 95
■ Feed support	75	■ Embroidery module	11, 114
■ Heirloom buttonhole	74, 82	■ Foot control	11, 12
■ Hight compensation tool	75	■ Optional accessory	11
■ Important Information	75	■ PC for embroidery software	11
■ In long term memory	83	■ Power cable	11
■ Keyhole buttonhole	74	■ Presser foot lifter	11, 13
■ Manual	85	■ USB	11
■ Marking	75	Contents	
■ Narrow buttonhole	74	■ Embroidery	111
■ Overview	74	■ Sewing	5
■ Programming	79-82	Cording	
■ Round buttonhole with horizontal bartack	74	■ Automatic buttonhole foot No. 3A	77
■ Round buttonhole with normal bartack	74	■ Buttonhole foot No. 3C	77
■ Stabilizer and interfacing	76	■ Fixing	77
■ Standard and stretch buttonhole	79	Correcting	
■ Standard buttonhole	74	■ Practical-/decorative stitches	54
■ Stitch counter buttonhole	82	Cover	
■ Straight stitch buttonhole	74	■ Thread take-up lever	11, 16
■ Stretch buttonhole	74	Creative consultant	
■ Test-sewing	75	■ Leaving	52
■ With direct length entry	80	■ Overview	52
		■ Recommendations	52
		■ Sewing techniques	52
		■ Types of fabric	52
C		D	
Cable		Darning	
■ Plugging in	12	■ Automatically	65-66
■ Unwind/wind	12	■ Manually	64
Calibrating		Darning- and embroidery thread	119
■ Automatic buttonhole foot No. 3A	46	Darning hoop connection	11
■ Display	44	Dealer details	49
Carrying handle	11	Decorative stitches	
Changing		■ Application	88
■ Bobbin case	15	■ Categories	88
■ Needle	16	■ Cross stitch	89
■ Stitch plate	19	■ Overview	88
Cleaning		■ Pin tucks	90
■ Display and sewing computer	158	■ Selecting	88
■ Feed dog area	158	■ Sewing lower thread	91
■ Hook	158		
■ Lubricating	158		
Combi mode	106-110, 141-142		
■ Correcting stitch pattern combination	108		
■ Creating embroidery motif combination	141		
■ Creating stitch pattern combination	106		
■ Deleting stitch patterns	107		
■ Opening saved combination	107		
■ Overwriting stitch pattern combination	110		
■ Programming practical stitches/ decorative stitches/alphabets	106		

Deleting

- Embroidery motifs 126, 127, 133, 152, 153
- User data 47, 153
- Stitch pattern 36, 39, 107, 110

Details

- Accessory 7-8, 112
- Embroidery module 113
- Sewing computer 10-11

Direct Selection-buttons

11, 26-27

Display

- Alphabets 34-35, 99
- Altering settings 41-42
- Balance 54
- BSR 95
- Buttonholes 32-33, 74
- Calibrating 44
- Combi mode 36-39
- Creative consultant 52
- Decorative stitches 88
- Edit 126
- Embroidery mode 123
- Embroidery-Alphabet 124
- Functions 30-39
- Help program 53
- Main display 28
- Menu selection 28
- Overview 28-39
- Practical stitches 56
- Quilt stitches 92
- Selecting the color 42
- Selection 29
- Setup 40-49
- Sewing 30-31
- Stitch pattern area 29
- Stitch pattern display 29
- Tutorial 50-51

E**eco 28, 55****Edit**

- Altering characters 127
- Altering embroidery motif proportionally 127
- Altering features of embroidery motif 127
- Color number 126
- Deleting embroidery motif 127
- Display 126
- Duplicating embroidery motif 127
- Embroidery menu 126
- Mirror image down/up 127
- Mirror image left/right 127
- Moving embroidery motif 127
- Moving enlarged embroidery motif within the hoop 126
- Overview 126
- Rotating embroidery motifs 127
- Selection 126
- Zoom minus 126
- Zoom plus 126

Embroidery 111-157

- Alphabet 124
- Embroidery motif 125
- Menu 155

- Start 154
- Thread breakage 157
- Via «Start/Stop»-button 155
- Via Foot control 156

Embroidery computer

- «Function»-buttons 122
- Embroidery needle 115, 119
- Entry in embroidery mode 123
- Lowering the feed dog 115
- Memory 149
- Preparation 115
- Straight stitch-/Cut Work stitch plate 115

Embroidery menu

- Color information bar 130
- Color number 131
- Disengage jump stitches 131
- Edit 131
- «Embroidery menu»/«Start/Stop»-button 131
- Embroidering motif by color/
reducing color changes 131
- Overview 130
- Presser foot indicator 130
- Security program 131
- Selection 130
- Single- or multi-colored motif 131
- Thread breakage 131
- Upper thread tension 130

Embroidery module

- Attaching 114
- Calibrating 128, 132
- Connecting 114
- Connecting cable 114
- Detail view 113
- Overview 113
- Parking 128, 129
- Removing 114

Embroidery motif

- Adding 133
- Altering features 144, 145
- Altering proportionally 126, 127, 137
- Altering thread brand 134, 146
- And lettering 143
- By BERNINA 125, 136
- Check 139
- Colors 146
- Creating combination 141-142
- Deleting 126-127, 133, 152-153
- Duplicating 126, 127
- Embroidering motif by color 131, 147
- Fill stitches 145
- From USB-Stick 125
- Grid 138
- Lettering 124, 142-144
- Mirror image 126, 127, 138
- Motif center 138
- Motif size and embroidery time 140
- Moving 126, 127, 137
- Moving enlarged motif 140
- Opening 133
- Overwriting 151
- Rotating 126, 127, 137
- Saving 133, 149-150
- Scaling/sizing 120

- Selecting 120, 135-136
 - Single- or multi-colored 131, 147, 148
 - Stick 125
 - Zoom 140
- Embroidery template 116**
- Embroidery test 120**
- Embroidery threads**
- Lower threads 119
 - Metallic threads 119
 - Polyester threads 119
 - Rayon thread 119
- Embroidery-/Sewing computer**
- Cleaning 158
 - Lubricating 158
 - Overview 10-11
 - Troubleshooting 159-163
- Entry**
- Embroidery mode 123
 - Sewing mode 123
- Environmental Protection 2**
- Examples of application**
- Decorative stitches 89-91
 - Practical stitches 61-71
- Eyelet**
- With small zig-zag 74, 87
 - With straight stitch 74, 87
- F**
-
- Fabric feed**
- Feed dog 22
- Feed dog**
- Fabric feed 22
 - Lowering 22, 115
 - Position 22
 - Ready to sew 22
 - Symbol 11, 115
- FHS 13**
- Finishing edges 66**
- Foam pad 7**
- Foot control**
- Cable unwind/wind 12
 - Connection 11, 12
 - Plugging in 12
 - Sewing speed control 12
- Front view**
- Sewing computer 10
- Function buttons 26-27**
- Automatic thread cutter 26, 122
 - Back 26
 - Needle position 27
 - Needle stop 26
 - Programmable pattern end/Securing 26
 - Quick reverse 26
 - Securing function 26
 - Slide speed control 26, 122
 - Start/Stop 26, 122
 - Stitch width and stitch length knob (multi functional) 27, 122
- Functions alphabets 34-35**
- Altering pattern length 35
 - Balance 35
 - Mirror image left/right/up/down 35
 - Needle position 34
 - Pattern repeat 34
 - Permanent sewing in reverse 35
 - Presser foot indicator 35
 - Presser foot pressure 35
 - Securing 34
 - Security program 35
 - Upper thread tension 34
- Functions buttonholes 32-33**
- Adjusting buttonhole length 32
 - Balance 33
 - Buttonhole slit width 33
 - Manual buttonhole 32
 - Presser foot indicator 33
 - Presser foot pressure 33
 - Programming buttonhole length 32
 - Securing 32
 - Security program 33
 - Stitch counter buttonhole 32
 - Upper thread tension 33
- Functions combi-mode 36-39**
- Altering pattern length 37
 - Balance 37
 - Combination repeat 39
 - Combination subdivider (1) 38
 - Combination subdivider (2) 38
 - Deleting 36
 - Deleting the whole combination 39
 - Editing combination at cursor position 36
 - Editing complete combination 36
 - Letter size with alphabets 37
 - Long stitch 37
 - Mirror image left/right/down/up 36, 37
 - Mirror image (left/right) the whole combination 39
 - Needle position 36
 - Permanent sewing in reverse 37
 - Presser foot indicator 37
 - Presser foot pressure 37
 - Securing 38
 - Security program 37
 - Upper thread tension 36
- Functions Sewing 30-31**
- Altering pattern length 31
 - Altering stitch density 31
 - Balance 31
 - Long stitch 31
 - Mirror image left/right 31
 - Mirror image up/down 31
 - Needle position 31
 - Needle stop down/up 30
 - Pattern begin 30
 - Pattern repeat 30

■ Permanent sewing in reverse	31
■ Presser foot indicator	31
■ Presser foot pressure	31
■ Securing	30
■ Security program	31
■ Upper thread tension	30

G

Glossary	6
-----------------	----------

Guidelines

■ Material/Thread/Needle size	24
-------------------------------	----

H

Handwheel	11
------------------	-----------

Height compensation of uneven layers	72
---	-----------

Heirloom buttonhole	74, 82
----------------------------	---------------

Help	53
-------------	-----------

Help program

■ Functions	53
■ Stitch pattern	53

Hight compensation tool	7, 72
--------------------------------	--------------

Hole for darning hoop	11
------------------------------	-----------

Hoop

■ Adjusting	43
■ Attaching/Removing	154
■ Basting box	132, 148
■ Calibrating	128, 132
■ Center determination	116
■ Embroidery template	116
■ Grid	128, 138
■ Hoop and motif size Check	128, 129, 139
■ Hoop selection/-display	128
■ Hooping material	116
■ Motif center	128
■ Moving	132
■ Moving the hoop	128, 132
■ Parking the embroidery module	128, 129
■ Selection	128, 139, 154
■ Using the hoop	116
■ Virtual positioning	128

Horizontal spool pin	11, 14, 16, 17
-----------------------------	-----------------------

I/J

Information	29, 30, 32, 34, 36, 38, 39, 48, 126, 128, 130, 132
--------------------	---

Inserting

■ Bobbin	15
■ Bobbin case	15
■ Free hand system	13
■ Needle	16
■ Stitch plate	19

Inserting bobbin	15
-------------------------	-----------

Jump stitches	121
----------------------	------------

K

Key to Signs	6
---------------------	----------

Knob

■ Stitch length/-width	11, 27
------------------------	--------

L

Leaving active display	30, 32, 34, 36, 38, 39
-------------------------------	-------------------------------

Lettering

■ Adjusting text to motif	143
■ Altering	126, 127
■ Altering type of lettering	144
■ And embroidery motif	143
■ Combining	142
■ Combined with embroidery motif	143
■ Embroidering multi-colored	148
■ Embroidering single-colored	147, 148
■ Multit-line lettering	143
■ Positioning	142

Long stitch	31
--------------------	-----------

Long term memory

■ Buttonhole	83
--------------	----

Lower thread

■ Bobbin-fil	119
■ Cutting	11, 15
■ Darning and embroidery threads	119
■ Free hand sewing	91
■ Indicator	45
■ Inserting bobbin	15
■ Sewing	91
■ Threading	15, 115
■ Winding	14
■ Winding while sewing	14
■ With decorative stitches	91

Lubricating	158
--------------------	------------

M

Main switch	11
--------------------	-----------

Maintenance

■ See cleaning	
----------------	--

Material, needle and thread	23
------------------------------------	-----------

Memory

■ Embroidery computer	149
■ Sewing computer	106-110

Menu selection

■ Alphabets	28
■ Buttonholes	28
■ Decorative stitches	28
■ Personal Program/Memory	28
■ Practical stitches	28
■ Stitch pattern selection via numbers	28

Metallic threads 119**Mirror image**

- Left/right/down/up 30-31, 34-35, 36-37, 39, 126, 127

Monitoring settings

- Lower thread indicator 45
- Upper thread indicator 45

Motif colors

- Altering thread brand 146
- Embroidering motif by color 147
- Embroidering single colored 147, 148
- Reallocating 146
- Reducing color changes 147

Moving the needle position 60**N****Needle**

- Double-, triple needle 25
- Embroidery needle 115, 119
- Guidelines 24
- Holder 11
- Important facts about thread and needle 23
- Inserting/removing 16
- Needle-thread-combination 24
- Overview 25
- Position 11, 27, 31, 34, 36
- Raise/lower 26, 30
- Replacing 16
- Stop down/up 26, 30
- Threading 17, 18

Needle threader 18**Needle, thread and material** 23**Needle-thread-combination** 24**O****Optional accessory**

- Connection 11

Overlock

- Double overlock 67
- Stitches 56-57

Overview

- Alphabets 99, 124, 167-170
- Buttonholes 74, 164
- Creative consultant 52
- Decorative stitches 88, 164-166
- Display 28-40, 123-134
- Edit 126
- Embroidery menu 130
- Embroidery mode 123
- Embroidery motifs 125, 171-181
- Function buttons 26-27, 122
- Functionen combi mode 36-39
- Functions alphabets 34-35
- Functions buttonholes 32-33
- Functions embroidery 126-134
- Functions sewing 30-31
- Main display 28

- Needle 25
- Practical stitches 56, 164
- Quilt stitches 92, 166
- Setup Display 40
- Sewing computer 10, 11
- Tutorial 50

P**Pattern begin** 30**Pattern repeat** 30**PC-connection** 11**Personal memory**

- Return to basic setting 59
- Temporary 59

Personal program

102-105

- Altering/overwriting stitch patterns 104
- Creating personal display 102
- Deleting stitch patterns 105
- Preparing stitch patterns 102
- Programming/preparing stitch patterns 102
- Stitch pattern selection in personal program 103

Polyester thread 23, 119**Power cable**

- Connection 11

Practical stitches

56-72

- Bartack program 57
- Basting stitch 57, 70
- Blind stitch 56, 69
- Blind stitch narrow 57
- Darning manual/automatic/reinforced 64-66
- Darning program 65, 66
- Darning stitch 57
- Double overlock 56, 67
- Gathering stitch 56
- Honeycomb stitch 56
- Jersey stitch 56
- Knit overlock 57
- Large Fly stitch 57
- Lycra stitch 57
- Reinforced darning program 57
- Reinforced overlock 57
- Running stitch 56
- Securing program 56, 70
- Selecting 58
- Sewn out zig-zag 56
- Simple darning program 57
- Single straight stitch 57
- Straight stitch 56, 61
- Stretch overlock 56
- Stretch stitch 57
- Super stretch 56
- Three single straight stitches 57
- Triple zig-zag 56, 62
- Triple-straight stitch 56, 61
- Universal stitch 56
- Vari-overlock 56
- Zig-zag 56
- Zipper 63

Preparation

- Embroidery 114-121
- Embroidery computer 115
- Embroidery module 114
- Sewing computer 12-25

Presser foot

- As guide 68
- Attaching/removing 18
- Changing 18
- Display 31, 33, 35, 37
- Overview 8
- Pressure 21, 31, 33, 35, 37
- Raise/lower 11, 13
- Standard Accessory 8

Presser foot lifter

- 11**
- Connection 11
- Inserting 13
- Raising and lowering the presser foot 13

Presser foot pressure

- Display 21
- Increase/loosen 21

Presser foot pressure adjustment wheel

11

Q**Quick Reverse button**

26

Quilt stitches

- Blanket stitch 92
- Blanket stitch (dual) 92
- Blind stitch (narrow) 92
- Decorative quilt stitch variations 92
- Double Blanket stitch (dual) 92
- Double blanket stitch 92
- Feather stitch 92
- Feather stitch variations 92
- Handlook quilt stitch 92
- Overview 92
- Quilt stitch/Straight stitch 92
- Quilters' securing program 92
- Satin stitch 92
- Stippling stitch 92

Quilting

- Free-motion quilting 93
- Stipple quilting 93
- With BSR 94-98

R**Rayon threads**

23, 119

Rear thread guide

11, 16

Removing

- Bobbin case 15
- Embroidery hoop 154
- Embroidery module 114
- Needle 16
- Presser foot 18
- Slide-on table 12
- Stitch plate 19

Reset

- Deleting user data 47
- Reset settings 47

Reset settings

47

S**Safety Instructions**

2

Satin stitch

66

Satin stitch

121

Save

- Embroidery motif 133, 149-150
- Stitch pattern 102-103
- Stitch pattern combination 106

Scrolling down/up

29

Seam

- Blind 69
- Edges 68
- Visible 69

Seam guide

13, 68

Seam ripper

7, 77

Securing

30

Securing program

42, 70

Selecting

- Display color 42
- Language 48
- Stitch pattern 29, 58

Selecting language

48

Selection

- Single and combi mode 29
- Scrolling down/up 29

Service data

49

Setting

- Confirming 30, 32, 34, 36, 38, 39
- Deleting 28

Setup Program

40-49

- Audio settings 44
- Basic setting 40, 47
- Beeper for BSR 44
- Brightness 41
- Calibrating automatic buttonhole foot No. 3A 46
- Calibrating display 44
- Display color 42
- Display settings 41
- Embroidery settings 43
- Information 48-49
- Monitoring setting 45
- Overview Display 40
- Reset 47
- Sewing light 41

- Sewing settings 41-43
 - Update 46
 - Updating sewing/embroidery computer 46
 - Welcoming text 41
 - Winder speed 45
- Sewing**
- Accessory 7-8
 - Alphabets 99
 - Blind hem 69
 - Buttonhole 79-85
 - Combinations 106
 - Corners 72
 - Edges 68
 - Eyelets 87
 - Flat joining seam 71
 - Function buttons 26-27
 - Hem visible 69
 - Quick reverse 26
 - Sewing on buttons 86
 - Sewing techniques 52
 - Zipper 63
- Sewing corners** 72
- Sewing in reverse**
- Permanent 31
- Sewing in the zipper** 63
- Sewing light** 41
- Sewing on button** 86
- Sewing settings**
- Altering upper thread tension 42
 - Automatic securing program 42
 - Automatic thread cutter 42
 - Sewing speed control 42
- Sewing speed** 12, 26, 42
- Sewing-/Embroidery Computer**
- Function buttons 26-27, 122
- Single and combi mode** 29
- Slide-on table**
- Attaching/removing 12
- Software version** 48
- Speed**
- Foot control 12
 - Regulating 11, 12, 26, 122
- Spool disc** 7, 14, 16
- Spool pin**
- Horizontal 11, 14, 16, 17
 - Vertical 11, 13
- Stabilizer** 117
- Embroidery stabilizer 117
 - Iron-on interfacing 118
 - Spray adhesive 117
 - Water soluble stabilizer 118
- Stabilizer and interfacing** 76
- Standard Accessory** 7-8, 112
- Start-/Stop-Button** 26, 122
- Starting to embroider** 154
- Step stitch** 121
- Stipple quilting** 93
- Stitch pattern selection**
- Direct 58
 - Menu selection 28
 - Stitch number 28, 58
- Stitch patterns**
- Adjusting individually 59
 - Deleting 36, 39, 107, 110
 - Display 29
 - Personal memory 59
 - Selecting 29, 58
- Stitch plate**
- As guide 68
 - Inserting/attaching 19
 - Maintenance 158
 - Marking 19
 - Removing 19
- Stitch selection**
- Cancelling 58
 - Direct 58
 - Via stitch number 58
- Stitch types**
- Jump stitches 121
 - Satin stitch 121
 - Step stitch 121
 - Underlay stitches 121
- Straight stitch** 56, 61
- Straight stitch-/CutWork stitch plate** 115
- System settings**
- Creative consultant 28, 52
 - Deleting settings 28
 - ECO 28, 55
 - Help 28, 53
 - Setup Program 28, 40
 - Tutorial 28, 50
-
- T**
- Tension** 20
- Thread**
- Breakage 157
 - Breaks 157
 - Embroidery threads 119
 - Important information about thread and needles 23
 - Needle-thread combination 24

Thread cutter	
■ Lower thread	11, 15
■ On the head frame	11, 18
■ Thread cutter in hook opening	11, 14
■ Automatic	11, 26, 42, 122
Thread cutter in hook opening	10-11, 15
Thread guide	
■ At the back	11, 16
■ Eyelet	11, 14
Thread take-up cover	11
Thread tension	
■ Back to basic setting	20
■ Embroidery motifs	115, 130
■ Upper thread	20
Thread, needle and material	23
Threader	18
Threading	
■ Double-/Triple needle	17
■ Lower thread	15
■ Needle	17, 18
■ Upper thread	16
Threading the double needle	17
Threading the triple needle	17
Top stitching edges	68
Topstitching	
■ Edges	68
■ Narrow/wide	68
Topstitching outer edges	68
Triple straight stitch	56, 61
Triple zig-zag	56, 62
Troubleshooting	159-163
Tutorial	28, 50
■ BSR	50
■ Buttonholes	50
■ Embroidery	50
■ Miscellaneous	50
■ Needle	50
■ Presser foot	50
■ Presser foot lifter (FHS)	50
■ Quilting	50
■ Sewing techniques	50
■ Thread/Threading	50
■ Troubleshooting	50
Types of fabric	52
Types of lettering	
■ Altering size	101
■ Choosing lower case letters	101
■ Combining	100
■ Correcting the combination	100
■ Overview	99, 124
■ Types	99, 124
U	
Underlay stitches	121
Update	46
Upper thread	
■ Indicator	45
■ Tension	20, 30, 42, 43, 130
■ Threading	16, 115
V	
Vertical spool pin	13
W	
Welcome text	
■ Entry/correction	41
Z	
Zoom	
■ Minus	126, 140
■ Plus	126, 140

Text

Herbert Stolz/Susanne Ribi

Graphics

www.sculpt.ch

Pictures

Patrice Heilmann, CH-Winterthur

Typesetting, Layout

Susanne Ribi

Copyright

2011 BERNINA International AG, CH-Steckborn

In partnership with



made to create **BERNINA**