



BERNINA 700

Bedienungsanleitung

Inhaltsverzeichnis

WICHTIGE SICHERHEITSHINWEISE	7	2.3 Anschluss und Einschalten	31
Wichtige Hinweise	9	Fussanlasser anschliessen (Sonderzubehör)	31
1 My BERNINA	11	Maschine anschliessen	31
1.1 Einführung	11	Eingabestift befestigen	32
1.2 BERNINA Qualitätskontrolle	11	Maschine einschalten	32
1.3 Willkommen in der Welt von BERNINA	11	Nählicht einschalten	32
1.4 Übersicht Maschine	13	2.4 Fussanlasser (Sonderzubehör)	32
Übersicht vorne Bedienelemente	13	Geschwindigkeit mit Fussanlasser regulieren	32
Übersicht vorne	14	Nadel nach oben/unten stellen	33
Übersicht seitlich	15	2.5 Garnrollenhalter	33
Übersicht hinten	16	Schwenkbarer Garnrollenhalter	33
Übersicht Stickmodul	17	Liegender Garnrollenhalter	34
1.5 Mitgeliefertes Zubehör	18	Mehrfach-Garnrollenhalter montieren	34
Übersicht Zubehör Maschine	18	2.6 Stickfuss	34
Zubehörbox	20	Nähfussposition mit der Taste «Nähfuss oben/unten» einstellen	34
Übersicht Zubehör Stickmodul	21	Stickfuss montieren	34
1.6 Übersicht Benutzeroberfläche	22	Stickfuss in der Benutzeroberfläche wählen	35
Übersicht Funktionen und Anzeigen	22	2.7 Nadel und Stichplatte	35
Übersicht Systemeinstellungen	22	Sticknadel montieren	35
Übersicht Auswahlmenü	22	Nadel in der Benutzeroberfläche wählen	36
Softwarebedienung	23	Nadeltyp und Nadelstärke wählen	36
1.7 Nadel, Faden, Stoff	25	Stichplatte montieren	37
Übersicht Nadeln	25	Stichplatte in der Benutzeroberfläche wählen	37
Beispiel für Nadelbezeichnung	26	2.8 Einfädeln	37
Nadel-Faden-Verhältnis	26	Oberfaden einfädeln	37
Oberfaden	26	Unterfaden aufspulen	40
Unterfaden	27	Unterfaden einfädeln	41
1.8 Wichtige Stickinformationen	27	Unterfaden heraufholen	43
Wahl des Stickmusters	27	Unterfadenmenge anzeigen	43
Wahl des Stickdateiformats	27	2.9 Stickmodul anschliessen	43
Stickprobe	28	2.10 Stickmuster wählen	44
Grösse des Stickmusters	28	2.11 Stickrahmen	44
Muster von Drittanbietern aussticken	28	Übersicht Stickrahmenauswahl	44
Unterlagenstiche	28	Stickrahmen wählen	45
Satin- oder Blattstich	28	Stickvlies zum Wegreissen	45
Steppstich	29	Stickvlies zum Wegschneiden	45
Verbindungsstiche	29	Klebespray verwenden	45
2 Stickvorbereitungen	30	Stärkespray verwenden	45
2.1 Vor dem ersten Gebrauch der Maschine	30	Klebeeinlage verwenden	45
2.2 Zubehörbox	30	Selbstklebeeinlage verwenden	46
Zubehörbox aufstellen	30	Wasserlösliche Einlage verwenden	46
Zubehör aufbewahren	30	Stickrahmen vorbereiten	46
		Stickrahmen montieren	47
		Übersicht Stickfunktionen	48



Stickrahmen zur Nadel zentrieren	48	5.5	Stickmuster bearbeiten	60
Stickrahmen nach hinten verschieben	48		Übersicht Stickmuster bearbeiten	60
Stickarm nach links verschieben	48		Stickmusteransicht vergrössern	60
Gitter ein/aus	49		Stickmusteransicht verkleinern	60
Stickmustermitte wählen	49		Stickmusteransicht verschieben	60
Stickrahmen virtuell positionieren	49		Stickmuster in vergrößerter Ansicht verschieben	61
3 Setup-Programm	50		Stickmuster verschieben	61
3.1 Stickeinstellungen	50		Stickmuster drehen	61
Oberfadenspannung einstellen	50		Stickmustergrösse proportional ändern	62
Maximale Stickgeschwindigkeit einstellen	50		Stickmustergrösse unproportional ändern	62
Stickmuster zentrieren oder in der Originalposition öffnen	50		Stickmuster spiegeln	63
Stickrahmen justieren	50		Stichart ändern	63
Stoffdicke einstellen	51		Stickdichte ändern	63
Faden-Entfernung ein-/ausschalten	51		Stickmustergrösse und -position prüfen	64
Vernähstiche einstellen	51		Bordüren sticken	64
Fadenschnitt einstellen	52		Stickmuster duplizieren	66
Masseinheit wechseln	53		Stickmuster löschen	66
3.2 Eigene Einstellungen wählen	53		Reihenfolge der Stickmusterkombination ändern	66
3.3 Überwachungsfunktionen	53		Eingaben rückgängig machen	67
Oberfadenwächter einstellen	53	5.6	Stickmuster gruppieren	67
Unterfadenwächter einstellen	53		5.6 Punktgenaue Platzierung	68
3.4 Ton einstellen	54		Rasterpunktpositionierung	68
3.5 Maschineneinstellungen	54		Freie Punktepositionierung	69
Sprache wählen	54	5.7	Stickmuster kombinieren	70
Displayhelligkeit einstellen	54		Stickmuster kombinieren	70
Nählicht einstellen	55		Einzelnes Stickmuster löschen	70
Display kalibrieren	55		Stickmuster duplizieren	70
Grundeinstellungen wiederherstellen	55		Kombination duplizieren	71
Eigene Daten löschen	55	5.8	Schriftzug erstellen	71
Muster auf dem BERNINA USB-Stick löschen	56		Übersicht Stickalphabet	71
Stickmodul verpacken	56		Schriftzug erstellen	73
Gesamtstichzahl prüfen	56		Schriftzug bearbeiten	73
Händlerdaten eintragen	56	5.9	Stickmusterfarben ändern	74
Servicedaten speichern	57		Übersicht Farben ändern	74
4 Systemeinstellungen	58		Farben ändern	74
4.1 Tutorial aufrufen	58		Farben mit dem Farbrad ändern	74
4.2 Stickberater aufrufen	58		Fadenmarke ändern	75
4.3 Hilfe aufrufen	58	5.10	Stickmuster sticken	76
4.4 eco-Modus verwenden	58		Übersicht Stickmenü	76
4.5 Mit «clr» alle Änderungen verwerfen	58		Heftstiche hinzufügen	76
5 Kreatives Sticken	59		Stickrahmen verschieben	76
5.1 Übersicht Sticken	59		Stickablaufkontrolle bei Fadenbruch	76
5.2 Stickmuster wählen und wechseln	59		Verbindungsstiche abschneiden	77
5.3 Stickzeit und Stickmustergrösse kontrollieren	59		Farbwechsel reduzieren	77
5.4 Geschwindigkeit regulieren	59		Mehrfarbiges Stickmuster ein/aus	77
			Bordüren sticken	77
			Farbanzeige	78
		5.11	Freiarmsticken	78
		5.12	Stickmuster verwalten	79
			Übersicht Stickmuster verwalten	79

Stickmuster im eigenen Speicher speichern	79	Tiere	121
Stickmuster auf dem BERNINA USB-Stick speichern	80	DesignWorks	123
Stickmuster im eigenen Speicher überschreiben	80	Monogramme rosa	124
Stickmuster auf dem BERNINA USB-Stick überschreiben	80	Monogramme blau	127
Stickmuster aus dem eigenen Speicher laden	80	Index	130
Stickmuster vom BERNINA USB-Stick laden	81		
Stickmuster aus dem eigenen Speicher löschen	81		
Stickmuster vom BERNINA USB-Stick löschen	81		
6 Sticken	82		
6.1 Sticken mit Taste «Start/Stop»	82		
6.2 Stickgeschwindigkeit erhöhen	82		
6.3 Oberfadenspannung einstellen	82		
6.4 Sticken mit Fussanlasser (Sonderzubehör)	83		
7 Pflege und Wartung	84		
7.1 Firmware	84		
Gesicherte Daten wiederherstellen	84		
Firmwareversion prüfen	84		
Firmware aktualisieren	84		
7.2 Maschine	85		
Display reinigen	85		
Fadenrückstände unter der Stichplatte entfernen	85		
Greifer reinigen	85		
Greifer ölen	86		
Fadenfänger reinigen	88		
8 Fehler und Störungen	89		
8.1 Fehlermeldungen	89		
8.2 Störungsbehebung	93		
9 Lagerung und Entsorgung	96		
9.1 Maschine lagern	96		
9.2 Maschine entsorgen	96		
10 Technische Daten	97		
11 Übersicht Muster	98		
11.1 Übersicht Stickmuster	98		
Stickmuster bearbeiten	98		
Projekte	98		
Quiltmuster	99		
Bordüren und Spitze	101		
Kinder	104		
Blumen	107		
Jahreszeiten	110		
Verzierungen	112		
Sport und Hobby	115		
Asia	117		
Bezaubernde Monogramme	118		



- Die Maschine ist doppeltisoliert (ausgenommen USA, Kanada und Japan). Nur Original-Ersatzteile verwenden. Hinweis für die Wartung doppeltisolierter Produkte beachten.
- Zum Ölen der Maschine nur von BERNINA empfohlenes Öl verwenden.

Schutzeinrichtungen

- Während des Betriebs der Maschine müssen alle Schutzzeinsätze angebracht und alle Deckel geschlossen sein.

Sachgemässe Verwendung

- Die Maschine darf von Kindern ab 8 Jahren oder von Personen mit verringerten physischen, sensorischen oder mentalen Fähigkeiten oder Mangel an Erfahrung und Wissen verwendet, gereinigt und gewartet werden.
- Diese Personen müssen während der Arbeit mit der Maschine beaufsichtigt sein, oder sie müssen den sicheren Umgang mit der Maschine und die daraus resultierenden Gefahren kennen.
- Kinder dürfen nicht mit der Maschine spielen.
- Besondere Vorsicht ist geboten, wenn die Maschine von Kindern oder im Beisein von Kindern verwendet wird.
- Maschine nur mit dem mitgelieferten Netzkabel verwenden.
- Das Netzkabel für USA und Kanada (Netzstecker NEMA 1-15) darf nur für eine Netzspannung von maximal 150 V zu Erde verwendet werden.
- Die Maschine nur mit dem mitgelieferten Fussanlasser des Typs LV-1 verwenden.
- Keine Gegenstände in die Öffnungen der Maschine stecken.
- Keine Gegenstände auf den Fussanlasser stellen.

- Während des Nähens den Stoff nur sachte führen. Ziehen und Stossen des Stoffes kann zu Nadelbruch führen.
- Finger von allen beweglichen Teilen fernhalten.
- Besondere Vorsicht ist im Bereich der Nadel erforderlich.
- Bei Tätigkeiten im Bereich der Nadel – wie Nadel einfädeln, Nadel wechseln, den Greifer einfädeln oder den Nähfuss wechseln – die Maschine ausschalten.
- Zum Ausschalten den Hauptschalter auf «0» stellen.
- Wenn Schutzabdeckungen entfernt werden, wenn die Maschine geölt wird oder wenn andere in dieser Bedienungsanleitung erwähnten Reinigungs- und Wartungsarbeiten durchgeführt werden, die Maschine ausschalten und Netzstecker aus der Steckdose ziehen.
- Netzstecker durch Ziehen am Stecker aus der Steckdose ziehen. Nicht am Kabel ziehen.

Sicherheitskennzeichen an der Maschine

Sicherheitszeichen	Bedeutung
	<p>Achtung, bewegliche Teile.</p> <p>Um die Verletzungsgefahr zu reduzieren, Maschine vor Wartungsarbeiten ausschalten.</p>

Wichtige Hinweise

Verfügbarkeit der Anleitung

Die Bedienungsanleitung ist Bestandteil der Maschine.



- Die Bedienungsanleitung der Maschine an einem geeigneten Ort in der Nähe der Maschine aufbewahren und zum Nachschlagen bereithalten.
- Bei Weitergabe der Maschine an Dritte, die Bedienungsanleitung der Maschine beilegen.
- Die neueste Version der Bedienungsanleitung kann unter www.bernina.com heruntergeladen werden.

Bestimmungsgemässe Verwendung

Ihre BERNINA Maschine ist für den privaten Hausgebrauch konzipiert und konstruiert. Sie dient zum Besticken von Stoffen und anderen Materialien wie in dieser Bedienungsanleitung beschrieben. Jede andere Verwendung gilt als nicht bestimmungsgemäss. BERNINA übernimmt keine Haftung für Folgen aus einer nicht bestimmungsgemässen Verwendung.

Ausstattung und Lieferumfang

In dieser Anleitung werden zur Veranschaulichung Beispielbilder verwendet. Die auf den Bildern gezeigten Maschinen und Zubehör müssen nicht zwingend dem tatsächlichen Lieferumfang Ihrer Maschine entsprechen. Das mitgelieferte Zubehör kann je nach Auslieferungsland Änderungen unterliegen. Erwähntes oder gezeigtes Zubehör, welches nicht im Lieferumfang enthalten ist, können Sie als Sonderzubehör bei einem BERNINA Fachhändler erwerben. Weiteres Zubehör finden Sie unter www.bernina.com.

Aus technischen Gründen und zwecks Verbesserung des Produkts können Änderungen bezüglich Ausstattung der Maschine und Lieferumfang jederzeit und ohne Vorankündigung vorgenommen werden.

Wartung doppeltisolierter Produkte

Ein doppeltisoliertes Produkt ist mit zwei Isolationseinheiten anstelle einer Erdung ausgestattet. Ein Erdungsmittel ist in einem doppeltisolierten Produkt nicht enthalten und sollte auch nicht eingesetzt werden. Die Wartung eines doppeltisolierten Produkts erfordert höchste Sorgfalt und beste Kenntnisse des Systems und sollte daher nur von qualifiziertem Personal vorgenommen werden. Es dürfen für Service und Reparatur nur Original-Ersatzteile verwendet werden. Ein doppeltisoliertes Produkt ist folgendermassen gekennzeichnet: «Doppeltisolierung» oder «doppeltisoliert».



Das Symbol kann ebenfalls ein solches Produkt kennzeichnen.

Umweltschutz

BERNINA International AG fühlt sich dem Umweltschutz verpflichtet. Wir bemühen uns, die Umweltverträglichkeit unserer Produkte zu erhöhen, indem wir diese bezüglich Gestaltung und Produktionstechnologie ununterbrochen verbessern.



Die Maschine ist mit dem Symbol des durchgestrichenen Mülleimers gekennzeichnet. Das bedeutet, dass die Maschine nicht im Haushaltsabfall entsorgt werden darf, wenn sie nicht mehr benötigt wird. Durch eine unsachgemässe Entsorgung können gefährliche Substanzen in das Grundwasser gelangen und damit in unsere Nahrungskette geraten und so unsere Gesundheit schädigen.

Die Maschine muss bei einer nahegelegenen Sammelstelle für Elektroaltgeräte oder bei einer Annahmestelle für die Wiederverwendung der Maschine kostenfrei zurückgegeben werden. Informationen zu den Sammelstellen erhalten Sie bei Ihrer Gemeindeverwaltung. Beim Neukauf einer Maschine ist der Händler verpflichtet, die alte Maschine kostenfrei zurückzunehmen und fachgerecht zu entsorgen.

Sofern die Maschine personenbezogene Daten enthält, sind Sie vor der Rückgabe der Maschine selbst für die Löschung der Daten verantwortlich.

Symbolerklärung



Kennzeichnet eine Gefahr mit hohem Risiko, die zu schwerer Verletzung oder ggf. sogar zum Tod führt, wenn sie nicht vermieden wird.



Kennzeichnet eine Gefahr mit mittlerem Risiko, die zu schweren Verletzungen führen kann, wenn sie nicht vermieden wird.



Kennzeichnet eine Gefahr mit geringem Risiko, die zu leichter oder mittlerer Verletzung führen kann, wenn sie nicht vermieden wird.



Kennzeichnet eine Gefahr, die zu Sachschaden führen kann, wenn sie nicht vermieden wird.



Tipps der BERNINA **Stickexpertinnen** finden Sie neben diesem Symbol.

In unserem Onlineshop können Sie die «inspiration» als E-Magazin oder als Print-Version erwerben, entweder einzeln oder als Abonnement. Zudem gibt es viele einzelne Download-Schnittmuster zu entdecken! Schauen Sie doch mal vorbei unter inspiration.bernina.com und folgen Sie uns auf Instagram ([inspiration.sewing.magazin](https://www.instagram.com/inspiration.sewing.magazin)).

BERNINA Blog



Raffinierte Anleitungen, kostenlose Schnittmuster und Stickvorlagen sowie viele neue Ideen: All das finden Sie jede Woche neu im Blog von BERNINA. Unsere Experten/-innen zeigen wertvolle Tipps und erklären Schritt für Schritt, wie Sie zum gewünschten Ergebnis kommen. In der Community können Sie eigene Projekte hochladen und sich mit anderen Näh-, Quilt- und Stickbegeisterten austauschen.

www.bernina.com/blog

Verfügbar in den Sprachen Englisch, Deutsch, Niederländisch und Französisch.

BERNINA Social Media



Folgen Sie uns in den sozialen Netzwerken und erfahren Sie mehr über Events, spannende Projekte sowie Tipps und Tricks rund ums Nähen, Quilten und Sticken. Wir halten Sie auf dem Laufenden und freuen uns, Ihnen das eine oder andere Highlight aus der Welt von BERNINA zu zeigen.

www.bernina.com/social-media

BERNINA App



Laden Sie sich die BERNINA App aus dem App Store auf Ihr Smartphone und genießen Sie direkten Zugang zu allen Produktinformationen. Im Zubehör-Organizer verschaffen Sie sich Überblick über Ihr Zubehör und jenes, welches Sie sich noch wünschen. Weiterhin haben Sie direkten Zugang zum Kundenportal, zum Blog und zum «inspiration»-Onlineshop und finden stets einen Fachhändler in Ihrer Nähe. Die App gibt's im Apple App Store und im Google Play Store. Direkte Links finden Sie unter: www.bernina.com/app



1.4 Übersicht Maschine

Übersicht vorne Bedienelemente



- | | | | |
|---|---------------------------------------|----|-----------------------------------|
| 1 | «Nählicht Ein/Aus» | 7 | «Stickmustergrösse kontrollieren» |
| 2 | «Fadenschneider» | 8 | «Unterfaden hoch» |
| 3 | «Nähfuss oben/unten» | 9 | «Multifunktionsknopf oben» |
| 4 | «Start/Stopp» | 10 | «Multifunktionsknopf unten» |
| 5 | «Stickrahmen zur Nadel zentrieren» | 11 | «Punktgenaue Platzierung» |
| 6 | «Stickrahmen nach hinten verschieben» | 12 | «Stickmustermitte» |

Übersicht vorne



- 1 Stickmodulanschluss
- 2 Greiferdeckel
- 3 Stickfuß
- 4 Nadeinfädler
- 5 Nählicht

- 6 Geschwindigkeitsregler
- 7 Fadengeberabdeckung
- 8 Fadengeber
- 9 Befestigungsschraube
- 10 Anschlagbetischanschluss

Übersicht seitlich



- | | | | |
|---|--------------------------------|----|---------------------------|
| 1 | Fussanlasseranschluss | 7 | Hauptschalter |
| 2 | Service-Anschluss | 8 | Netzkabelanschluss |
| 3 | Garnrollenhalter | 9 | Magnethalter Eingabestift |
| 4 | Spuleinheit mit Fadenschneider | 10 | Lüftungsschlitze |
| 5 | Schwenkbarer Garnrollenhalter | 11 | USB-Anschluss |
| 6 | Handrad | | |

Übersicht hinten



- 1 Anschließetischanschluss
- 2 Lüftungsschlitze
- 3 Fadenführung Öse
- 4 Tragegriff

- 5 Spulervorspannung
- 6 Fadenführung
- 7 Fadenschneider
- 8 Stichplatte

Übersicht Stickmodul



- | | | | |
|---|-------------------------------------|---|-----------------------------------|
| 1 | Stickarm | 3 | Führungsschienen für die Maschine |
| 2 | Kupplung für Stickrahmenbefestigung | 4 | Anschluss an die Maschine |



1.5 Mitgeliefertes Zubehör



Weitere Informationen und Anwendungshinweise zum mitgelieferten und optionalen Zubehör finden Sie unter: <https://www.bernina.com/700#!accessories>

Übersicht Zubehör Maschine







Abbildung	Name	Verwendungszweck
	Staubschutzhaube	Zum Schutz der Maschine vor Staub und Schmutz.
	BERNINA Zubehörbox	Zum Aufbewahren des mitgelieferten Zubehörs sowie Sonderzubehörs.
	Mehrfach-Garnrollenhalter	Zum schnellen Zugriff auf die Garnrollen und Fadenwechsel, z. B. bei mehrfarbigen Stickmustern. Für einen längeren Weg zur Nadel und damit zur Möglichkeit schwierige Garne vor dem Sticken zu entwirren.
	Fadenablaufscheibe	Für ein gleichmässiges Abfließen des Fadens von der Garnrolle.
	Spule für B9-Greifer 4 Stück	Zum Aufspulen des Unterfadens.
	Schaumstoffteller 2 Stück	Der Schaumstoffteller verhindert das Rutschen, Verheddern oder Reißen des Fadens am Garnrollenhalter.
	Eingabestift	Zur präzisen Bedienung des Touch-Bildschirms.

Abbildung	Name	Verwendungszweck
	Pfeiltrenner	Zum Auftrennen von Nähten und Aufschneiden von Knopflöchern.
	Schraubendreher, grau Torx	Zum Wechseln der Nadel.
	Schraubendreher, rot (Schlitz)	Zum Lösen und Festziehen von Schlitzschrauben.
	Winkelschraubendreher Torx	Zum Öffnen des Kopfdeckels.
	Pinsel/Nadeleinsetzer	Zum Reinigen des Transporteurs und Greiferbereichs.
	Nähmaschinen-Öl	Zum Ölen der Maschine.
	Netzkabel	Zum Verbinden der Maschine mit dem Stromnetz.

Zubehörbox

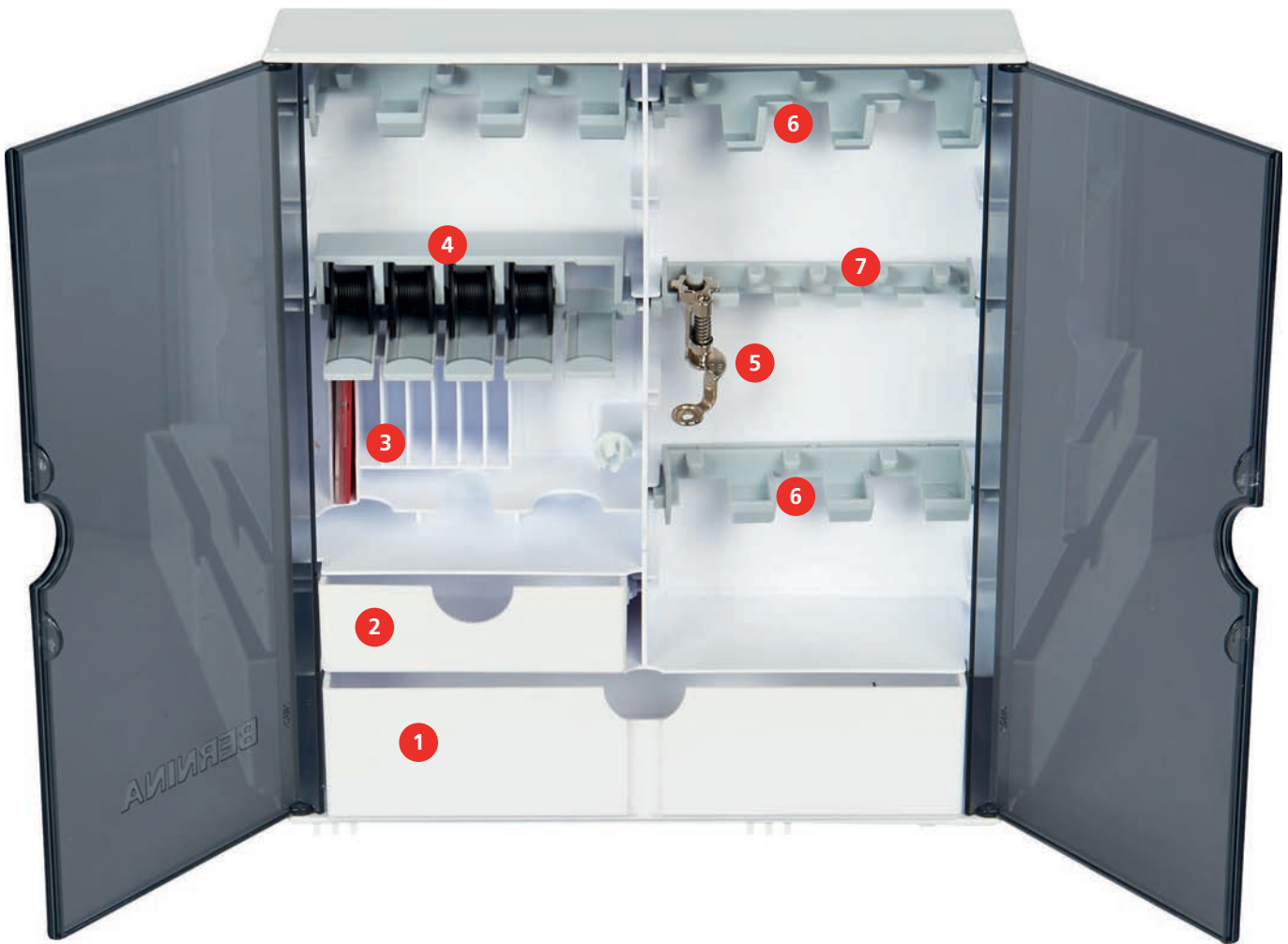

- 1 Grosse Schublade
- 2 Kleine Schublade
- 3 Nadelsortiment
- 4 Spulenhalter

- 5 Stickfuss
- 6 Stickfusshalter 9,0 mm Füsse
- 7 Stickfusshalter 5,5 mm Füsse

Übersicht Zubehör Stickmodul

Abbildung	Name	Verwendungszweck
	Tropfenförmiger Stickfuss #26	Zum Sticken, Stopfen und Freihandquiltten.
	Grosser, ovaler Stickrahmen	Zum Sticken von grossflächigen Stickmustern oder Motivkombinationen bis 145 x 255 mm (5,70 x 10,04 in). Inkl. Schablone zum genauen Platzieren des Stoffes.
	Mittlerer Stickrahmen	Zum Sticken von mittelgrossen Stickmustern bis 100 x 130 mm (3,94 x 5,12 in). Inkl. Schablone zum genauen Platzieren des Stoffes.
	Kleiner Stickrahmen	Zum Sticken von kleinen Stickmustern bis 72 x 50 mm (2,83 x 1,97 in). Zum Freiharmsticken von geschlossenen Nähprojekten wie Ärmeln, Hosenbeinen oder Socken. Inkl. Schablone zum genauen Platzieren des Stoffes.
	Sticknadelsortiment	Zum Sticken.
	Stickschablonenhalter	Zum Einsetzen und Entfernen der Stickschablone in den Stickrahmen.
	Spulennetz	Zum gleichmässigen Fadenabzug bei glatten Fäden von der Fadenspule wie z. B. Nylon-, Rayon-, Seidenfäden oder Metallicgarne.

1.6 Übersicht Benutzeroberfläche

Übersicht Funktionen und Anzeigen



- | | | | |
|---|---------------------------------|---|---|
| 1 | «Oberfadenspannung» | 4 | «Stickrahmenanzeige/Stickrahmenauswahl» |
| 2 | «Nadelauswahl» | 5 | «Stichplattenauswahl» |
| 3 | «Nähfussanzeige/Nähfussauswahl» | 6 | «Unterfaden» |

Übersicht Systemeinstellungen

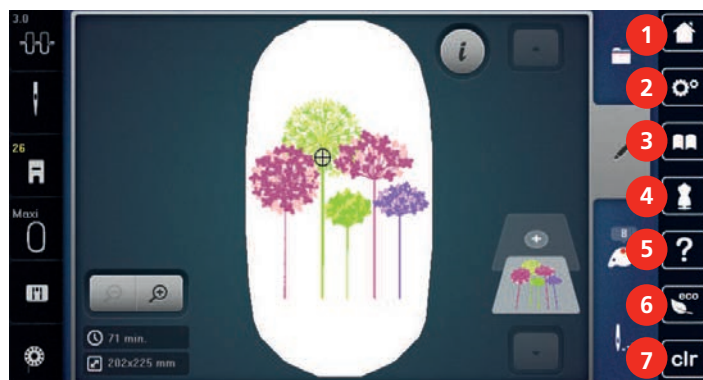

- | | | | |
|---|------------------|---|-------------------------|
| 1 | «Home» | 5 | «Hilfe» |
| 2 | «Setup-Programm» | 6 | «eco-Modus» |
| 3 | «Tutorial» | 7 | «Einstellungen löschen» |
| 4 | «Stickberater» | | |

Übersicht Auswahlmennü

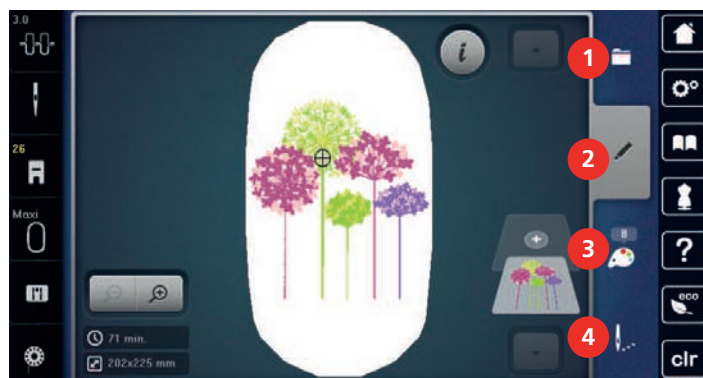

- | | | | |
|---|--------------|---|---------------------|
| 1 | «Auswahl» | 3 | «Farbinformationen» |
| 2 | «Bearbeiten» | 4 | «Sticken» |

Softwarebedienung







Der berührungssensitive Bildschirm lässt sich mit dem Finger oder dem Eingabestift bedienen.

Tippen: Kurzes Antippen eines Elements.





Wischen: Antippen eines Elements und eine schnelle Wischbewegung auf dem Bildschirm.

Ziehen: Antippen des Bildschirms und langsam in eine Richtung bewegen, z. B. zum Hoch- und Runterscrollen.



Navigation

Abbildung	Name	Verwendungszweck
	«Home»	«Home-Bildschirm» anzeigen.
	Navigationspfad	Eine vorherige Menüebene anzeigen.
	«Schliessen»	Das Fenster schliessen.
	Mehr	Weitere Funktionen oder Informationen anzeigen.
	Weiter	Eine Anzeige weiterblättern.
	Zurück	Eine Anzeige zurückblättern.

Funktionen aktivieren/deaktivieren

Abbildung	Element	Status
	Schalter	Funktion ist aktiviert.
		Funktion ist deaktiviert.
	Feld	Funktion ist deaktiviert.
		Funktion ist aktiviert.

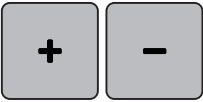
Werte anpassen

Abbildung	Name	Verwendungszweck
	Schieberegler	Den Wert mit dem Regler einstellen. Den Wert durch Antippen des kleinen Punktes auf den Grundwert zurückstellen.
	Felder «Plus» / «Minus»	Den Wert mit «Plus» erhöhen, mit «Minus» reduzieren.
	Gelbe Umrahmung	Anzeige, dass der eingestellte Wert vom Standardwert abweicht. Den Wert durch Antippen auf den Grundwert zurückstellen.

Text und Zahlen eingeben

Zur Eingabe von Zahlenwerten oder Text wird eine entsprechende Tastatur angezeigt.







Abbildung	Name	Verwendungszweck
	Eingabefeld	Anzeige der Eingabe. Mit einem Antippen alle eingegebenen Zeichen löschen.
	«Löschen»	Das letzte Zeichen löschen.
	«Kleinschrift»	Die verfügbaren Buchstaben in Kleinschrift anzeigen.
	«Grossschrift»	Die verfügbaren Buchstaben in Grossschrift anzeigen.
	«Zahlen und mathematische Zeichen»	Die verfügbaren Zahlen und mathematischen Zeichen anzeigen.
	«Sonderzeichen»	Die verfügbaren Sonderzeichen anzeigen.
	«Bestätigen»	Die Eingabe bestätigen und das Untermenü verlassen.
	«Abbrechen»	Die Eingabe abbrechen und das Ansichtsfenster schliessen.

1.7 Nadel, Faden, Stoff

Im Laufe der Zeit nutzt sich eine Nadel ab. Sie sollte deshalb regelmässig ausgetauscht werden. Nur eine einwandfreie Spitze führt zu einem saubereren Stich. Generell gilt: Je feiner ein Stoff, umso feiner sollte auch die Nadel sein. Die dargestellten Nadeln sind je nach Maschine Standard- oder Sonderzubehör.

- Nadelstärken 70, 75: für leichte Stoffe.
- Nadelstärken 80, 90: für mittlere Stoffe.
- Nadelstärken 100, 110 und 120: für schwere Stoffe.

Übersicht Nadeln

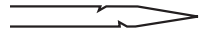
Abbildung	Nadelbezeichnung	Nadelbeschreibung	Verwendungszweck
 ■	Jersey-/Stick-Nadel 130/705 H SUK 80/12	Mit mittlerer Kugelspitze.	Für Webwaren (leicht, mittel, schwer), Strickwaren, Kunststoff. Zum Nähen allgemein, Knöpfe annähen und Knopflöcher, Reissverschlüsse, Säume und Absteppen, dekorativen Nähen, Sticken.
 ■	Stick-Nadel 130/705 H-E 75/11 – 90/14	Mit kleiner Kugelspitze, breitem Nadelöhr und breiter Fadenrinne.	Für Webwaren (leicht, mittel, schwer), Strickwaren. Für dickere Fäden und Wollfäden. Zum Nähen allgemein, Knöpfe annähen und Knopflöcher, Reissverschlüsse, Säume und Absteppen, dekorativen Nähen, Sticken.
 ☒	Feine-Materialien-Nadel 130/705 H SES 70/10 – 90/14	Mit kleiner Kugelspitze.	Für feine, empfindliche Materialien, z. B. Samt. Zum Nähen allgemein, Knöpfe annähen und Knopflöcher, Reissverschlüsse, Säume und Absteppen, dekorativen Nähen, Sticken, Patchworken, Quilten.
 ■	Metafil-Nadel 130/705 H METAFIL 80/12	Mit mittlerer Kugelspitze und 2 mm langem Nadelöhr.	Für Webwaren (leicht, mittel, schwer), Strickwaren. Zum Verarbeiten von Spezial- und Effektfäden, besonders für Metallfäden. Zum Sticken mit Metallfäden. Zum Säumen und Absteppen, dekorativen Nähen und Sticken.
	Filz-Nadel PUNCH	Mit kleinen Widerhaken.	Für Webwaren (leicht, mittel, schwer), Jeans/Denim. Zum Einfilzen von diversen Garnen und Fäden in Basisstoffe.

Beispiel für Nadelbezeichnung

Das für Haushaltsnäähmaschinen gebräuchliche 130/705-System wird anhand der nachfolgenden Grafik einer Jersey-/Stretchnadel beispielhaft erklärt.

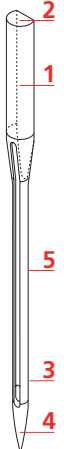
	<p>130/705 H-S/70</p> <p>130 = Schaftlänge (1)</p> <p>705 = Flachkolben (2)</p> <p>H = Hohlkehle (3)</p> <p>S = Spitzenform (hier mittlere Kugelspitze) (4)</p> <p>70 = Nadelstärke 0.7 mm (5)</p>
---	--

Nadel-Faden-Verhältnis

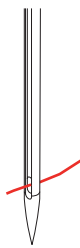
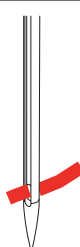
	<p>Das Nadel-Faden-Verhältnis ist richtig, wenn sich der Faden beim Nähen passgenau in die lange Rille und durch das Nadelöhr führen lässt. Der Faden kann optimal vernäht werden.</p>
	<p>Der Faden kann reißen und es können Fehlstiche entstehen, wenn der Faden zu viel Spielraum in der langen Rille und im Nadelöhr hat.</p>
	<p>Der Faden kann reißen und sich verklemmen, wenn der Faden an den Kanten der langen Rille scheuert und sich nicht optimal durch das Nadelöhr führen lässt.</p>

Oberfaden

Eine gute Qualität (Markenhersteller) ist bei Stickfäden wichtig, damit die Stickerei nicht durch Fadenunregelmässigkeiten oder Fadenbruch beeinträchtigt wird.

Stickereien sind besonders wirkungsvoll, wenn als Oberfaden glänzende, feine Stickgarne verwendet werden. Fadenhersteller bieten eine grosse Faden- und Farbpalette an.

- Glanz-Polyesterfaden ist ein strapazierfähiger, reissfester und farbechter Faden, der sich für alle Arten von Stickereien eignet.
- Viscose ist eine feine, naturähnliche Faser mit Seidenglanz, die sich für feine Stickereien eignet, welche nicht zu fest strapaziert werden.



- Metallfaden ist ein feiner bis mitteldicker glänzender Faden, der sich für Spezialeffekte in der Stickerei eignet.
- Bei Metallfäden sollte der automatische Unterfadenschneider ausgeschaltet und auch die anderen Fadenschneider nicht verwendet werden, da sich die Messer sonst sehr schnell abnützen können.
- Bei Metallfäden sollten die Geschwindigkeit und die Oberfadenspannung reduziert werden.



Unterfaden

Meistens wird beim Stickern schwarzer oder weisser Unterfaden verwendet. Wenn beide Seiten gleich aussehen sollen, dann ist es zu empfehlen, einen gleichfarbigen Unter- und Oberfaden zu verwenden.

- Bobbin Fill ist ein besonders weicher und leichter Polyesterfaden, der sich als Unterfaden gut eignet. Dieser spezielle Unterfaden sorgt für eine gleichbleibende Fadenspannung und für eine optimale Verschlingung von Ober- und Unterfaden.
- Stopf- und Stickfäden sind feine mercerisierte Baumwollfäden, die sich für Stickereien auf Baumwollstoff eignen.



1.8 Wichtige Stickinformationen

Wahl des Stickmusters

Einfache Stickmuster mit geringer Stichzahl eignen sich für Stickereien auf feinen Stoffen. Dicht gestickte Stickmuster, z. B. Stickmuster mit vielen Farb- und Stickrichtungswechseln, eignen sich für gröbere und schwerere Stoffe.

Wahl des Stickdateiformats

Damit Stickmuster von der BERNINA Stickmaschine gelesen werden können, müssen sie mit der BERNINA Sticksoftware hergestellt und als .EXP-Datei exportiert werden. Neben der eigentlichen Stickdatei werden zusätzlich eine .BMP-Datei und eine .INF-Datei generiert. Die .BMP-Datei ermöglicht eine Bildvorschau des Stickmusters und die .INF-Datei enthält die Informationen zu den Fadenfarben. **Hinweis:** Fehlt die .INF-Datei, wird das Stickmuster nicht mit den korrekten Fadenfarben, sondern nur mit Standardfarben angezeigt. In diesem Fall können die Farben manuell in der Farbübersicht des Musters auf der Maschine eingetragen werden.

Zusätzlich können folgende Stickformate von der Maschine gelesen werden: .SEW, .PES, .PEC, .XXX, .PCS, .JEF und .DST. BERNINA International AG gibt keine Garantie, dass die Stickmuster, welche nicht mit der BERNINA Sticksoftware hergestellt oder konvertiert wurden, korrekt gelesen und ausgestickt werden.

Stickprobe

Eine Stickprobe sollte immer auf einem Reststück des Originalstoffs gestickt und mit der später verwendeten Einlage verstärkt werden. Für die Stickprobe ist es empfehlenswert, dieselben Farben, Fäden und Nadeln zu verwenden, die auch für das Stickprojekt zum Einsatz kommen sollen.

Grösse des Stickmusters

Stickmuster können in der Stickmaschine oder auf dem PC mit der BERNINA Sticksoftware (Sonderzubehör) vergrössert oder verkleinert werden. Vergrösserungen und Verkleinerungen bis zu 20 % ergeben die besten Resultate.

Muster von Drittanbietern aussticken

BERNINA empfiehlt, Stickmuster jeglichen Dateiformats über das kostenlose Programm «ART-Link» auf einen USB-Stick zu laden. Mit «ART-Link» wird sichergestellt, dass Stickmuster korrekt gelesen und ausgestickt werden. «ART-Link» kann unter www.bernina.com/artlink kostenlos heruntergeladen werden.

Unterlagenstiche

Unterlagenstiche bilden die Grundlage eines Stickmusters und sorgen für eine Stabilisierung und Formerhaltung des Stickgrunds. Sie sorgen auch dafür, dass die Deckstiche des Stickmusters weniger tief in die Maschen oder den Flor des Stoffs versinken.

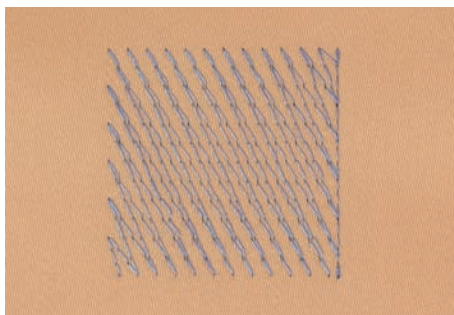

Satin- oder Blattstich

Der Satinstich sticht abwechselnd auf der einen und auf der gegenüberliegenden Seite ein, sodass der Faden die Figur in einem sehr dichten Zickzackmuster deckt. Satinstiche eignen sich zum Füllen schmaler und kleiner Formen. Sie sind zum Ausfüllen grosser Flächen ungeeignet, da lange Stiche zu lose sind und den Stoff nicht richtig decken. Es besteht die Gefahr, dass bei zu langen Stichen die Fäden an etwas hängen bleiben und die Stickerei dadurch beschädigt wird.

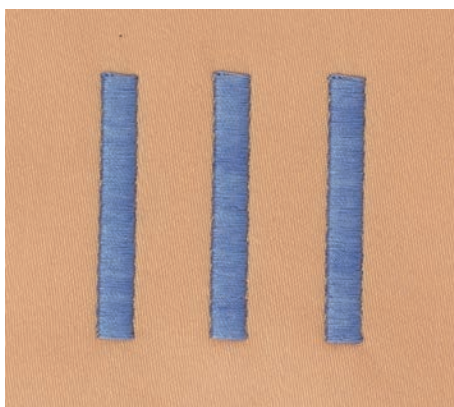

2 Stickvorbereitungen

2.1 Vor dem ersten Gebrauch der Maschine



BERNINA empfiehlt vor dem ersten Gebrauch der Maschine oder nach längerem Stillstand, den Greifer zu ölen. (siehe Seite 84)

Durch das Ölen des Greifers kann das Auftreten von unerwünschten Geräuschen im Greiferbereich vermieden werden.

2.2 Zubehörbox

Zubehörbox aufstellen

> Die beiden Schwenkfüße auf der Rückseite der Box ausklappen, bis sie einrasten.



Zubehör aufbewahren



- > Halterungen (1) für Spulen, Füße und Nadeln einsetzen.
- > Kleinteile in den Schubladen (2) und (3) aufbewahren, z. B. Fadenablaufscheiben.
- > Mitgeliefertes Nadelsortiment im Spezialfach (4) aufbewahren.

ACHTUNG

Zerkratzte Sensorflächen der Spule

Fehlfunktion des Unterfadenwächters. Wenn die Sensorflächen der Spulen zerkratzt oder verschmutzt sind, erkennt der Unterfadenwächter den niedrigen Fadenstand nicht mehr.

- > Spulen immer mit der silbernen Sensorfläche nach rechts in den Spulenhalter einlegen.
- > Spulen so in das Fach (5) der Zubehörbox einlegen, dass sich die silbernen Sensorflächen auf der rechten Seite befinden.
- > Um die Spule herauszunehmen, Federtaste nach unten drücken.
- > Stickfüße in den Halterungen (6) (5,5 mm oder 9,0 mm) aufbewahren.

Eingabestift befestigen

- > Den Eingabestift an der Magnethalterung befestigen.



Maschine einschalten

- > Hauptschalter auf «I» stellen.



Nählicht einschalten

Voraussetzung:

- Nählicht muss im Setup-Programm eingeschaltet sein.



- > Um das Nählicht auszuschalten, Taste «Nählicht Ein/Aus» drücken.
- > Um das Nählicht einzuschalten, Taste «Nählicht Ein/Aus» erneut drücken.
 - Das Ein- und Auschalten des Nählichts kann auch im Setup-Programm durchgeführt werden. (siehe Seite 55)

2.4 Fussanlasser (Sonderzubehör)

Geschwindigkeit mit Fussanlasser regulieren

Mit dem Fussanlasser kann die Geschwindigkeit stufenlos angepasst werden.

- > Um die Maschine zu starten, Fussanlasser vorsichtig nach unten drücken.
- > Um schneller zu sticken, mit mehr Druck auf den Fussanlasser drücken.
- > Um die Maschine zu stoppen, Fussanlasser loslassen.



Nadel nach oben/unten stellen

- > Um Nadel nach oben/unten zu stellen, Fussanlasser mit der Ferse nach unten drücken.



2.5 Garnrollenhalter

Schwenkbarer Garnrollenhalter

Garnrollenhalter aufstellen



Bei Metallic- oder anderen Spezialfäden ist es empfehlenswert, den schwenkbaren Garnrollenhalter zu verwenden.

Der schwenkbare Garnrollenhalter wird beim Sticken mit Spezialfäden benötigt und kann auch zum Spulen während des Stickens benutzt werden.

- > Garnrollenhalter nach oben bis zum Anschlag aufstellen.



Schaumstoffteller und Garnrolle einsetzen

Der Schaumstoffteller verhindert das Anhängen des Fadens am schwenkbaren Garnrollenhalter.

- > Schaumstoffteller auf den schwenkbaren Garnrollenhalter stecken.
- > Garnrolle auf Garnrollenhalter stecken.



Liegender Garnrollenhalter

Schaumstoffteller, Garnrolle und Fadenablaufscheibe einsetzen

Die Fadenablaufscheibe sorgt für den gleichmässigen Ablauf des Fadens von der Garnrolle. Die Fadenablaufscheibe wird nur beim liegenden Garnrollenhalter verwendet.

- > Schaumstoffteller auf den Garnrollenhalter stecken.
- > Garnrolle auf Garnrollenhalter stecken.
- > Passende Fadenablaufscheibe so auf die Garnrolle setzen, dass kein Spielraum zwischen der Fadenablaufscheibe und der Garnrolle besteht.

Spulennetz verwenden

Das Spulennetz hält den Faden auf der Garnrolle und verhindert das Verknoten und das Reißen des Fadens. Das Spulennetz wird nur beim liegenden Garnrollenhalter verwendet.

- > Spulennetz über die Garnrolle schieben. Dabei sicherstellen, dass das Spulennetz nicht von der Garnrolle rutscht, z. B. Netz doppelt über die Garnrollen stülpen oder einen Teil des Netzes hinten in die Garnrolle stecken.



Mehrfach-Garnrollenhalter montieren

Ausführliche Informationen zur Montage des Mehrfach-Garnrollenhalters befinden sich in der separaten Bedienungsanleitung des Mehrfach-Garnrollenhalters.

2.6 Stickfuss

Nähfussposition mit der Taste «Nähfuss oben/unten» einstellen



- > Um den Nähfuss anzuheben, Taste «Nähfuss oben/unten» drücken.
- > Um den Nähfuss zu senken, Taste «Nähfuss oben/unten» erneut drücken.

Stickfuss montieren

- > Nadel hochstellen.
- > Maschine ausschalten und vom Stromnetz trennen.
- > Befestigungshebel nach oben drücken (1).
- > Stickfuss von unten in die Halterung einführen (2).



- > Befestigungshebel nach unten drücken.



Stickfuss in der Benutzeroberfläche wählen

Nach der Montage des entsprechenden Stickfusses kann dieser ausgewählt und auf der Maschine gespeichert werden. Darüber hinaus werden alternative Füße angezeigt, die für das jeweils gewählte Stickmuster zur Verfügung stehen.

- > Maschine einschalten.
- > Stickmuster wählen.
- > «Nähfussanzeige/Nähfussauswahl» antippen.



- > Um alle geeigneten Füße für das gewählte Stickmuster anzuzeigen, «Optionale Nähfüsse» antippen.
- > Montierten Stickfuss wählen.

2.7 Nadel und Stichplatte

Sticknadel montieren



Sticknadeln des Typs 130/705 H-SUK verfügen über ein grösseres Ohr und sind leicht gerundet. Dies wirkt der Fadenabreibung beim Einsatz von Rayon- und Baumwollstickgarnen entgegen. Je nach Stickfaden empfehlen sich Nadelstärken Nr. 70-SUK bis Nr. 90-SUK.

- > Nadel hochstellen.
- > Maschine ausschalten.
- > Montierten Fuss entfernen.
- > Befestigungsschraube der Nadel mit dem Schraubendreher grau Torx lösen.



- > Nadel nach unten ziehen.
- > Neue Nadel mit der flachen Seite nach hinten halten.
- > Nadel bis zum Anschlag nach oben schieben.
- > Befestigungsschraube mit dem Schraubendreher grau Torx festziehen.

Nadel in der Benutzeroberfläche wählen

Nach dem Wechseln der Nadel kann geprüft werden, ob diese mit der gewählten Stichplatte verwendet werden kann.



- > «Nadelauswahl» antippen.
- > Montierte Nadel wählen.



- Wenn die gewählte Nadel in Verbindung mit der Stichplatte geeignet ist, kann mit dem Sticken begonnen werden.
- Wenn die gewählte Nadel in Verbindung mit der Stichplatte nicht geeignet ist, wird das Starten der Maschine automatisch verhindert.

Nadeltyp und Nadelstärke wählen

Praktische Erinnerungsfunktion: Damit keine Informationen verloren gehen, können Nadeltyp und Nadelstärke zusätzlich auf der Maschine gespeichert werden. Der gespeicherte Nadeltyp und die gespeicherte Nadelstärke können so jederzeit überprüft werden.



- > «Nadelauswahl» antippen.



- > «Nadelinformationen» antippen.



- > Nadeltyp (1) der montierten Nadel wählen.
- > Nadelstärke (2) der montierten Nadel wählen.

Stichplatte montieren

Die Stichplatte hat im Bereich der Nadel ein kleines Loch. Der Fadeneinzug (Fadenverknötung von Ober- und Unterfaden) wird dadurch optimiert. Dies ergibt ein schöneres Stickbild.

Voraussetzung:

- Maschine ist ausgeschaltet und vom Stromnetz getrennt.
 - Fuss und Nadel entfernt.
- > Stichplatte an der Markierung hinten rechts nach unten drücken, bis sie abkippt.



- > Stichplatte entfernen.
- > Öffnungen der Stichplatte (PunchWork, Sonderzubehör) über den entsprechenden Führungsstiften platzieren und nach unten drücken, bis sie einrastet.



Stichplatte in der Benutzeroberfläche wählen

Nach dem Wechseln der Stichplatte kann geprüft werden, ob diese mit der gewählten Nadel verwendet werden kann.



- > «Stichplattenauswahl» antippen.
- > Montierte Stichplatte (PunchWork, Sonderzubehör) wählen.



- Wenn die gewählte Nadel in Verbindung mit der Stichplatte geeignet ist, kann mit dem Sticken begonnen werden.
- Wenn die gewählte Nadel in Verbindung mit der Stichplatte nicht geeignet ist, wird das Starten der Maschine automatisch verhindert.

2.8 Einfädeln

Oberfaden einfädeln

Voraussetzung:

- Nadel und Nähfuss sind hochgestellt.
- Maschine ist ausgeschaltet.

- > Schaumstoffteller auf den Garnrollenhalter stecken.
- > Garnrolle so auf den Garnrollenhalter stecken, dass der Faden im Uhrzeigersinn abgewickelt wird.
- > Passende Fadenablaufscheibe aufstecken.
- > Faden in Pfeilrichtung durch die hintere Fadenführung (1) führen und dabei den Faden mit den Händen so festhalten, dass er gespannt ist und in die Fadenspannung eingelegt werden kann.
- > Faden in Pfeilrichtung durch die Fadenspannung (2) führen.

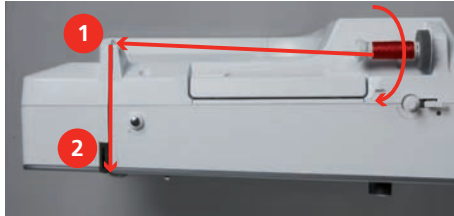

- > Faden nach unten (3) um die Fadengeberabdeckung (4) herum führen.
- > Faden nach oben führen und in den Fadengeber (5) einlegen.
- > Faden wieder nach unten (6) führen.

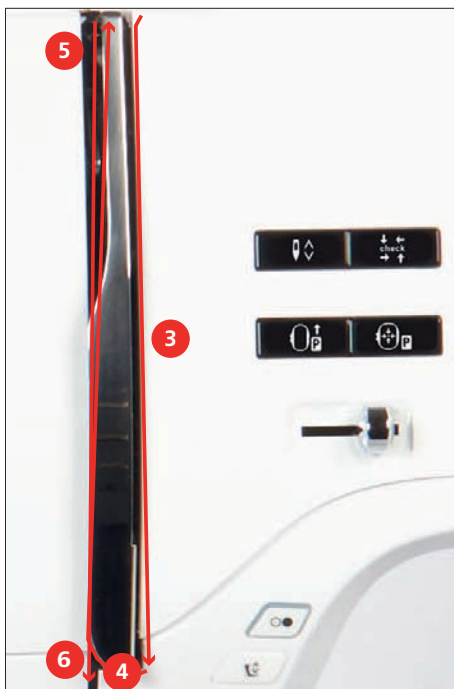

- > Faden durch die Führungen (7/8) oberhalb des Nähfusses führen.



- > Maschine einschalten.

- > Faden unter dem Nähfuß und von hinten nach vorne über den Fadenschneider (15) ziehen und abschneiden.



Unterfaden aufspulen



Der Unterfaden kann auch während des Stickens aufgespult werden, wenn für das Aufspulen der schwenkbare Garnrollenhalter verwendet wird.

Voraussetzung:

- Schaumstoffteller, Garnrolle und passende Fadenablaufscheibe sind montiert.
- > Leere Spule so auf die Spuleinheit (1) stecken, dass die silbernen Sensorflächen nach unten gerichtet sind.



- > Faden nach links in die hintere Fadenführung (2) führen.
- > Faden im Uhrzeigersinn um die Spulervorspannung (3) führen.
- > Faden im Uhrzeigersinn 2 – 3-mal auf die leere Spule (4) wickeln.

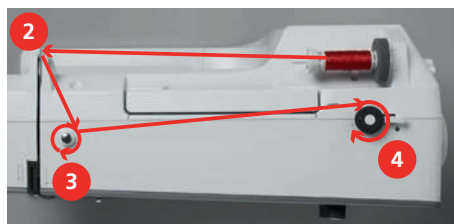

- > Restfaden über den Fadenschneider am Einschalthebel (5) ziehen und abschneiden.



- > Einschalthebel (6) gegen die Spule drücken.



- Die Maschine spult und das Display zum Spulen erscheint.
- > Spulgeschwindigkeit einstellen.
- > Um den Spulvorgang zu stoppen, muss der Einschalthebel nach rechts gedrückt werden.
- > Um den Spulvorgang fortzusetzen, Einschalthebel erneut gegen die Spule drücken.
 - Wenn die Spule gefüllt ist, stoppt die Maschine den Spulvorgang automatisch.
- > Spule abnehmen und den Faden mit dem Fadenschneider am Einschalthebel abschneiden.

Unterfaden einfädeln

Voraussetzung:

- Nadel ist hochgestellt.
- Maschine ist ausgeschaltet und der Greiferdeckel ist geöffnet.
- > Auslöseklappe an der Spulenkapselform drücken (1).

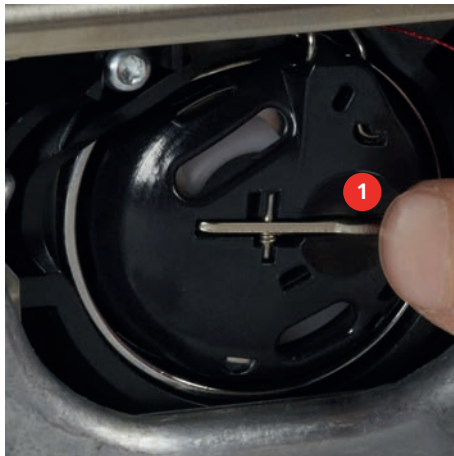

- > Spulenkapselform entfernen.
- > Spule aus der Spulenkapselform entfernen.
- > Neue Spule so einsetzen, dass die silbernen Sensorflächen nach hinten gegen die Spulenkapselform gerichtet sind.



- > Faden von links in den Schlitz (2) hineinziehen.



- > Faden nach rechts unter die Feder (3) ziehen, unter den zwei Fadenführungen (4) durchführen und nach oben ziehen.



- > Zum Einsetzen in die Maschine die Spulenkapsel so halten, dass die Fadenführung (5) nach oben zeigt.



- > Spulenkapsel einsetzen.
- > Auf die Mitte der Spulenkapsel drücken, bis sie einrastet.



- > Faden durch den Fadenschneider (6) ziehen und abschneiden.

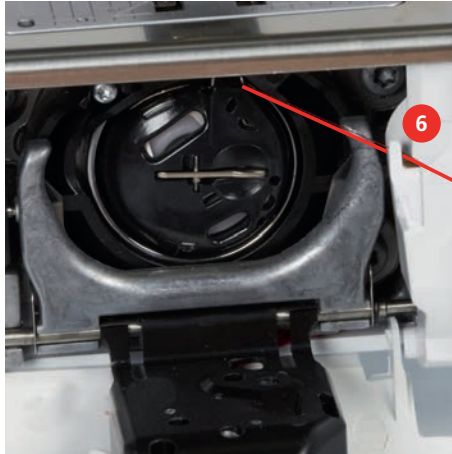

- > Greiferdeckel schliessen.

Unterfaden heraufholen

Um den Unterfaden heraufholen zu können, muss die Maschine zum Sticken bereit sein. Der Unterfaden kann in einem Schritt für eine manuelle Verknotung heraufgeholt werden. Falls keine Vernähstiche gewünscht sind, ist es empfehlenswert, die Vernähstiche im Setup-Programm auszuschalten.

- > Oberfaden festhalten.
- > Taste «Nähfuss oben/unten» drücken.
 - Unterfaden wird automatisch heraufgeholt.



Unterfadenmenge anzeigen

Sobald die Unterfadenmenge kritisch wird, wird im Feld «Unterfaden» eine Animation angezeigt, dass der Unterfaden fast zu Ende ist.



- > Um den Unterfaden gemäss Animation einzufädeln, «Unterfaden» antippen.

2.9 Stickmodul anschliessen

ACHTUNG

Transport des Stickmoduls

Beschädigung an Stickmodulanschluss und Maschine.

- > Stickmodul vor dem Transport von der Maschine entfernen.

Voraussetzung:

- Anstiehetisch darf nicht montiert sein.
- > Stickmodul und Maschine auf einer stabilen, ebenen Fläche aufstellen.
- > Sicherstellen, dass der Stickarm ungehindert bewegt werden kann.
- > Stickmodul auf der linken Seite anheben.
- > Stickmodul von links nach rechts vorsichtig in den Stickmodulanschluss der Maschine (1) schieben.

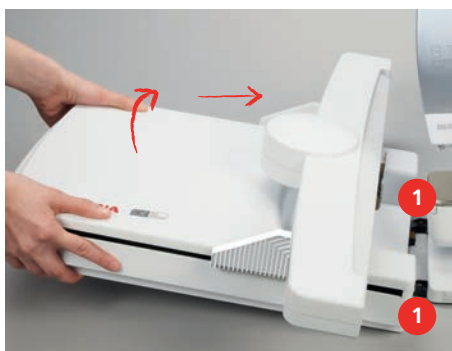

- > Stickmodul zum Entfernen auf der linken Seite anheben und vorsichtig nach links wegziehen.

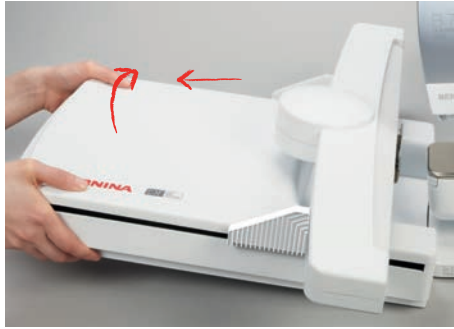

2.10 Stickmuster wählen

Alle Stickmuster lassen sich entweder direkt aussticken oder können mit den verschiedenen Funktionen, welche die Maschine anbietet, verändert werden. Alle Stickmuster finden Sie am Ende dieser Bedienungsanleitung. Darüber hinaus können Stickmuster aus dem eigenen Speicher oder vom BERNINA USB-Stick (Sonderzubehör) geladen werden.

Voraussetzung:

- Tropfenförmiger Stickfuß #26 ist montiert.
- > Alphabet, Stickmuster oder eigenes Stickmuster aus einem der Ordner wählen.

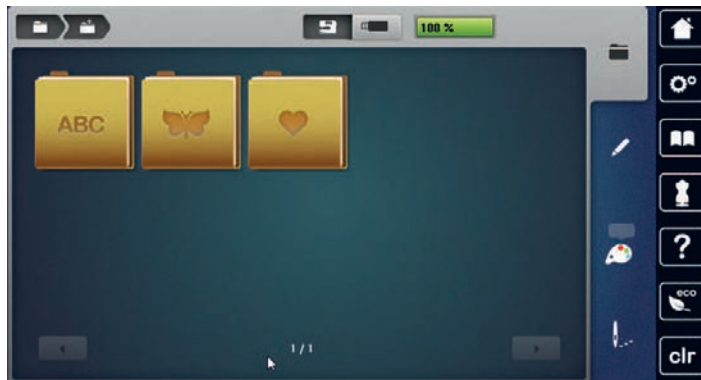

2.11 Stickrahmen

Übersicht Stickrahmenauswahl

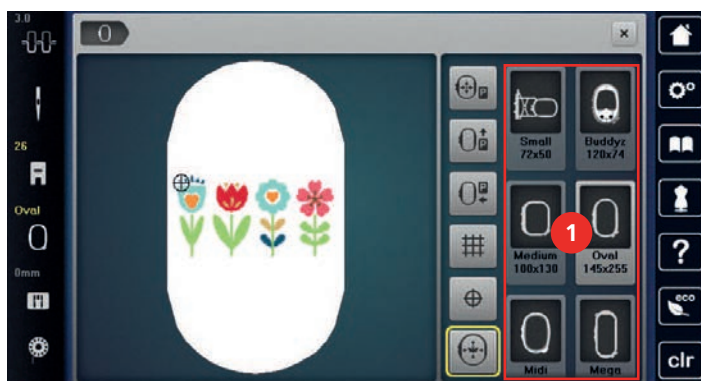

- 1 Stickrahmenauswahl

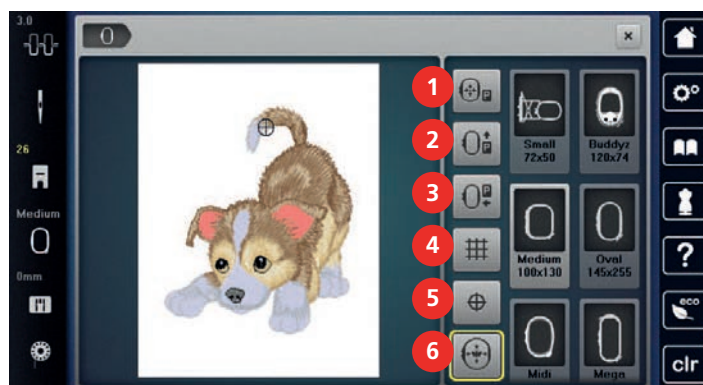

Übersicht Stickfunktionen



- | | | | |
|---|---------------------------------------|---|----------------------------|
| 1 | «Stickrahmen zur Nadel zentrieren» | 4 | «Gitter ein/aus» |
| 2 | «Stickrahmen nach hinten verschieben» | 5 | «Stickmustermitte» |
| 3 | «Stickrahmen nach links verschieben» | 6 | «Virtuelle Positionierung» |



Stickrahmen zur Nadel zentrieren

Das Verschieben des Stickrahmens erleichtert das Einfädeln des Oberfadens, wenn sich die Nadel in der Nähe des Stickrahmens befindet.



-  > «Stickrahmenanzeige/Stickrahmenauswahl» antippen.
-  > «Stickrahmen zur Nadel zentrieren» antippen.
> Oberfaden einfädeln.
-  > Um den Stickrahmen zur letzten Position zurückzubewegen, Taste «Start/Stop» drücken.

Stickrahmen nach hinten verschieben

Damit die Unterfadenspule einfacher gewechselt werden kann, empfiehlt es sich, den Stickrahmen vor dem Einfädeln nach hinten zu verschieben. Dadurch wird der Greiferdeckel besser zugänglich.

-  > «Stickrahmenanzeige/Stickrahmenauswahl» antippen.
-  > «Stickrahmen nach hinten verschieben» antippen.
> Unterfaden einfädeln. (siehe Seite 41)
-  > Um den Stickrahmen zur letzten Position zurückzubewegen, Taste «Start/Stop» drücken. Evtl. Oberfaden zurückziehen.

Stickarm nach links verschieben

-  > «Stickrahmenanzeige/Stickrahmenauswahl» antippen.
> Stickrahmen entfernen.
-  > «Stickrahmen nach links verschieben» antippen.
– Eine Animation «Stickrahmen entfernen» erscheint.
-  > «Bestätigen» antippen.
– Der Stickarm fährt nach links in die Parkposition.

3 Setup-Programm

3.1 Stickeinstellungen

Oberfadenspannung einstellen

Änderungen an der Oberfadenspannung im Setup-Programm haben Auswirkungen auf alle Stickmuster.



> «Setup-Programm» antippen.



> «Stickeinstellungen» antippen.



> «Oberfadenspannung einstellen» antippen.
> Oberfadenspannung einstellen.

Maximale Stickgeschwindigkeit einstellen

Mit dieser Funktion kann die maximale Geschwindigkeit reduziert werden.



> «Setup-Programm» antippen.



> «Stickeinstellungen» antippen.



> «Maximale Stickgeschwindigkeit» antippen.
> Maximale Geschwindigkeit einstellen.

Stickmuster zentrieren oder in der Originalposition öffnen

Beim Öffnen der Stickmuster auf der Maschine werden diese immer im Stickrahmen zentriert. Falls gewünscht wird, dass Stickmuster in der Originalposition (von der BERNINA Sticksoftware bestimmt) geöffnet werden sollen, muss die Funktion «Stickmuster zentrieren» eingeschaltet werden.



> «Setup-Programm» antippen.



> «Stickeinstellungen» antippen.



> «Stickmuster zentrieren» antippen.



> Schalter antippen.
– Ein verschobenes und in dieser Position gespeichertes Stickmuster wird beim Anwählen in der gespeicherten Position geöffnet.



> Schalter erneut antippen.
– Das Stickmuster wird im Stickrahmen zentriert.

Stickrahmen justieren

Die Stickrahmenjustierung ist die Abstimmung der Nadel zur Mitte des Stickrahmens.

Voraussetzung:



- Stickmodul ist angeschlossen und der Stickrahmen mit der entsprechenden Stickschablone ist montiert.



> «Setup-Programm» antippen.





> «Stickeinstellungen» antippen.

-  > «Stickrahmen justieren» antippen.
-  > Um die aktuelle Justierung zu löschen, «Löschen» (1) antippen.
- > Nadel mithilfe der Pfeilfelder auf dem Display genau in die Mitte stellen.







Stoffdicke einstellen

Wenn die Stoffdicke z. B. bei Frottee mehr als 4 mm beträgt, dann ist es zu empfehlen, 7,5 mm oder 10 mm zu wählen. Je dicker der Stoff, umso langsamer stickt die Maschine. Beim Ausschalten der Maschine werden die Änderungen auf Grundeinstellung 4 mm zurückgesetzt.

-  > «Setup-Programm» antippen.
-  > «Stickeinstellungen» antippen.
-  > «Stoffdicke einstellen» antippen.
- > Stoffdicke wählen.

Faden-Entfernung ein-/ausschalten

Um das Fadenende nach dem Abschneiden nach oben und aus dem Stoff herauszuziehen, muss die Funktion eingeschaltet werden. Bei Stickmustern mit langen Stichen ist es zu empfehlen, die Funktion Faden-Entfernung auszuschalten. Wenn der Abstand zwischen Nähfuß und Stickrahmen zu gering ist, wird die Funktion nicht ausgeführt.







-  > «Setup-Programm» antippen.
-  > «Stickeinstellungen» antippen.
-  > «Faden-Entfernung» antippen.
-  > Faden-Entfernung ein-/ausschalten.

Vernähstiche einstellen

Stickmuster sind mit oder ohne Vernähstiche programmiert. Hat ein Stickmuster programmierte Vernähstiche, werden diese gestickt. Wenn Stickmuster mit Vernähstichen programmiert sind, können die Vernähstiche mit Hilfe der BERNINA Sticksoftware entfernt werden.

Die Maschine erkennt, wenn keine Vernähstiche programmiert sind und fügt welche dazu. Falls keine Vernähstiche gewünscht sind, können diese ausgeschaltet werden.

-  > «Setup-Programm» antippen.



-  > «Stickeinstellungen» antippen.
-  > «Vernähstiche» antippen.
-  > Um die Vernähstiche am Anfang auszuschalten, Schalter im oberen Bereich ausschalten.
 - Hat ein Stickmuster keine programmierte Vernähstiche, werden keine gestickt.
-  > Um die Vernähstiche am Anfang einzuschalten, Schalter im oberen Bereich einschalten.
 - Hat ein Stickmuster keine programmierte Vernähstiche, werden Vernähstiche hinzugefügt und gestickt.
-  > Um die Vernähstiche am Ende auszuschalten, Schalter im unteren Bereich ausschalten.
 - Hat ein Stickmuster keine programmierte Vernähstiche, werden keine gestickt.
-  > Um die Vernähstiche am Ende einzuschalten, Schalter im unteren Bereich einschalten.
 - Hat ein Stickmuster keine programmierte Vernähstiche, werden Vernähstiche hinzugefügt und gestickt.

Fadenschnitt einstellen

Die Fadenschnitteinstellungen können auf die eigenen Bedürfnisse angepasst werden. Schalten Sie den Fadenschnitt vor einem Fadenwechsel ab (1), oder passen Sie die Länge des Verbindungsstichs an (3). Die Maschine übernimmt für Sie das Schneiden der Verbindungsfäden ab der eingestellten Länge. Zuerst einstellen, ab welcher Länge die Verbindungsstiche geschnitten werden, dann das Stickmuster wählen.



Die Länge des Verbindungsfadens kann von 1 mm bis 15 mm eingestellt werden, die Grundeinstellung liegt bei 6 mm. Das bedeutet, dass alle Verbindungsstiche, die länger als 6 mm sind, automatisch geschnitten werden. Reduziert man den Wert auf 1 mm erfolgen daher mehr Fadenschnitte, die Stickzeit erhöht sich, und auf der Stoffunterseite sind mehr lose Fadenenden zu sehen, insbesondere, wenn zusätzlich die Funktion Faden-Entfernung aktiviert ist. Auf der Oberseite gibt es dadurch keine oder nur sehr kurze Verbindungsstiche, was zu einem wunderschönen Stickbild führt. Die Länge des Fadenschnitts auf 1 mm zu reduzieren, ist vor allem beim Sticken von Texten vorteilhaft, bei denen in der Regel sehr viele kurze Spannfäden entstehen. Wenn beide Seiten des Stichmusters sichtbar sind, mag es sinnvoll sein, die Länge des Fadenschnitts nicht so stark zu reduzieren, damit auf der Unterseite nicht zu viele lose Fäden entstehen, die im Verlauf festgestickt werden und nur schwer zu entfernen sind.

-  > «Setup-Programm» antippen.
-  > «Stickeinstellungen» antippen.
-  > «Fadenschnitteinstellungen» antippen.



-  > Um den automatischen Fadenschnitt vor einem Fadenwechsel auszuschalten, Schalter im oberen Bereich des Displays (1) antippen.
- > Um den automatischen Fadenschnitt vor einem Fadenwechsel einzuschalten, Schalter im oberen Bereich des Displays (1) erneut antippen.

- > Damit die Maschine nach ca. 7 Stichen stoppt und der Restfaden von Hand abgeschnitten werden kann, Schalter im mittleren Bereich des Displays (2) antippen.
- > Damit die Maschine nicht für den manuellen Fadenschnitt stoppt, Schalter im mittleren Bereich des Displays (2) erneut antippen.
- > Um einzustellen, ab welcher Länge die Verbindungsstiche geschnitten werden, «Minus» oder «Plus» (3) antippen.

Masseinheit wechseln

Die Masseinheit im Stickmodus kann von mm in inch gewechselt werden. Standardeinstellung ist in mm.



- > «Setup-Programm» antippen.



- > «Stickeinstellungen» antippen.



- > «Masseinheit» antippen.
- > Um Abmessungen im Stickmodus in inch anzuzeigen, «inch» antippen.
- > Um Abmessungen im Stickmodus in mm anzuzeigen, «mm» antippen.

3.2 Eigene Einstellungen wählen



- > «Setup-Programm» antippen.



- > «Persönliche Einstellungen» antippen.
- > Gewünschte Displayfarbe und Hintergrund wählen.
- > Textfeld oberhalb der Farbeinstellungen antippen.
- > Begrüßungstext eingeben und bestätigen.

3.3 Überwachungsfunktionen

Oberfadenwächter einstellen



- > «Setup-Programm» antippen.



- > «Überwachungsfunktionen» antippen.



- > Um den Oberfadenwächter auszuschalten, Schalter im oberen Bereich des Displays antippen.
- > Um den Oberfadenwächter einzuschalten, Schalter erneut antippen.

Unterfadenwächter einstellen



- > «Setup-Programm» antippen.







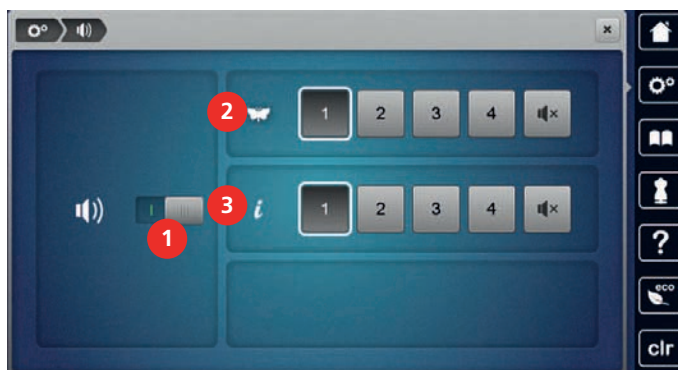

- > «Überwachungsfunktionen» antippen.

- > Um den Unterfadenwächter auszuschalten, Schalter im unteren Bereich des Displays antippen.
- > Um den Unterfadenwächter einzuschalten, Schalter erneut antippen.

3.4 Ton einstellen





-  > «Setup-Programm» antippen.
-  > «Toneinstellungen» antippen.
-  > Um den Ton bei Anwahl eines Stickmusters auszuschalten, im Bereich (2) «Töne ein-/ausschalten» antippen.
-  > Um den Ton bei Anwahl eines Stickmusters einzustellen, im Bereich (2) «1 – 4» antippen.
-  > Um den Ton für das Anwählen von Funktionen auszuschalten, im Bereich (3) «Töne ein-/ausschalten» antippen.
-  > Um den Ton für das Anwählen von Funktionen einzustellen, im Bereich (3) «1 – 4» antippen.

3.5 Maschineneinstellungen



Sprache wählen

Die Benutzeroberfläche kann je nach Kundenwunsch auf die gewünschte Sprache eingestellt werden, da BERNINA ein breites Spektrum an internationalen Sprachen für die Kunden zur Verfügung stellt. Per Firmware Update werden ggf. neue Sprachen für die Benutzeroberfläche zur Verfügung gestellt.

-  > «Setup-Programm» antippen.
-  > «Maschineneinstellungen» antippen.
-  > «Sprachauswahl» antippen.
- > Sprache wählen.

Displayhelligkeit einstellen

Die Helligkeit des Displays kann auf die eigenen Bedürfnisse eingestellt werden.

-  > «Setup-Programm» antippen.
-  > «Maschineneinstellungen» antippen.
-  > «Bildschirmeinstellungen» antippen.
- > Helligkeit des Display im oberen Bereich des Displays einstellen.

Muster auf dem BERNINA USB-Stick löschen

- > BERNINA USB-Stick in den USB-Anschluss der Maschine einstecken.
- > «Setup-Programm» antippen.



- > «Maschineneinstellungen» antippen.



- > «Werkseinstellung» antippen.



- > «USB-Stick löschen» antippen und bestätigen.

Stickmodul verpacken

Damit das Stickmodul, ohne den Stickarm von Hand zu verschieben, in der Originalverpackung untergebracht werden kann, muss der Stickarm zuvor in die Packposition gebracht werden.

Voraussetzung:

- Stickmodul ist an die Maschine angeschlossen.



- > «Setup-Programm» antippen.



- > «Maschineneinstellungen» antippen.



- > «Wartung/Update» antippen.



- > «Packposition» antippen.
- > Anweisungen auf dem Display folgen.

Gesamtstichzahl prüfen

Die Gesamtstichzahl der Maschine sowie die Stichzahl seit dem letzten, durch den BERNINA Fachhändler ausgeführten Service, werden angezeigt.



- > «Setup-Programm» antippen.



- > «Maschineneinstellungen» antippen.



- > «Informationen» antippen.



- > «Maschinendaten» antippen.

Händlerdaten eintragen

Die Kontaktdaten Ihres BERNINA Fachhändlers können eingetragen werden.







- > «Setup-Programm» antippen.



- > «Maschineneinstellungen» antippen.







- > «Informationen» antippen.

-  > Um die Händlerdaten einzutragen, «Händlerdaten» antippen.
-  > Um den Namen des BERNINA Fachhändlers einzutragen, «Name» antippen.
-  > Um die Adresse des BERNINA Fachhändlers einzutragen, «Adresse» antippen.
-  > Um die Telefonnummer des BERNINA Fachhändlers einzutragen, «Telefonnummer» antippen.
-  > Um die Internetseite oder E-Mail-Adresse des BERNINA Fachhändlers einzutragen, «E-Mail-Adresse» antippen.

Service­daten speichern

Die Service­daten über den aktuellen Zustand der Maschine können auf dem BERNINA USB-Stick gespeichert und dem BERNINA Fachhändler zugestellt werden.

- > USB-Stick mit genügend freiem Speicherplatz in den USB-Anschluss der Maschine einstecken.
-  > «Setup-Programm» antippen.
-  > «Maschineneinstellungen» antippen.
-  > «Informationen» antippen.
-  > «Service­daten» antippen.
-  > «Service­daten exportieren» antippen.
 - Das Feld «Service­daten exportieren» erhält eine weiße Umrandung.
- > Wenn die weiße Umrandung nicht mehr angezeigt wird, USB-Stick entfernen.

4 Systemeinstellungen

4.1 Tutorial aufrufen

Das Tutorial gibt Informationen und Erklärungen zu verschiedenen Bereichen des Sticksens.



- > «Tutorial» antippen.
- > Um Informationen zu erhalten, gewünschtes Thema wählen.

4.2 Stickberater aufrufen

Der Stickberater informiert über Entscheidungshilfen zu Stickprojekten. Nach Eingabe des gewünschten Stickprojekts und des Stoffes werden zum Beispiel Vorschläge zu der geeigneten Nadel und zum passenden Stickfuss angezeigt.



- > «Stickberater» antippen.
- > Stickprojekt wählen.
- > Stoff wählen, auf dem gestickt werden soll.



- > «Bestätigen» antippen.
 - Ist bereits ein Stickmuster angewählt, erscheint eine Warnung, dass dieses überschrieben wird.

4.3 Hilfe aufrufen



- > Fenster auf dem Display aufrufen, zu dem Hilfe benötigt wird.
- > Um den Hilfe-Modus zu starten, «Hilfe» antippen.
- > Feld auf dem Display antippen, zu dem eine Hilfestellung benötigt wird.

4.4 eco-Modus verwenden

Bei längerer Arbeitsunterbrechung kann die Maschine in den Sparmodus versetzt werden. Der Sparmodus dient gleichzeitig als Kindersicherung. Auf dem Display kann nichts gewählt und die Maschine kann nicht gestartet werden.



- > Um den Sparmodus einzuschalten, «eco-Modus» antippen.
 - Das Display schaltet sich aus. Der Stromverbrauch wird reduziert und das Nählicht ausgeschaltet.
- > Um den Sparmodus auszuschalten, «eco-Modus» erneut antippen.

4.5 Mit «clr» alle Änderungen verwerfen

Alle Änderungen an den Mustern können auf Grundeinstellung zurückgesetzt werden. Ausgenommen sind gespeicherte Muster, die im eigenen Speicher gespeichert wurden und Überwachungsfunktionen.



- > «Einstellungen löschen» antippen.

5 Kreatives Sticken

5.1 Übersicht Sticken



- | | | | |
|---|--|---|-------------------|
| 1 | Stickzeit/Stickmustergröße | 4 | «i-Dialog» |
| 2 | Stickmusteransicht vergrößern, verkleinern und verschieben | 5 | Stickmusterebenen |
| 3 | Bestickbare Fläche | | |

5.2 Stickmuster wählen und wechseln



- > «Auswahl» antippen.



- > «Stickmuster laden» antippen.
- > Neues Stickmuster wählen.

5.3 Stickzeit und Stickmustergröße kontrollieren

Im Auswahlmenü «Bearbeiten» wird unten links (1) die geschätzte Stickzeit in Minuten sowie die Breite und Höhe des Stickmusters angezeigt.

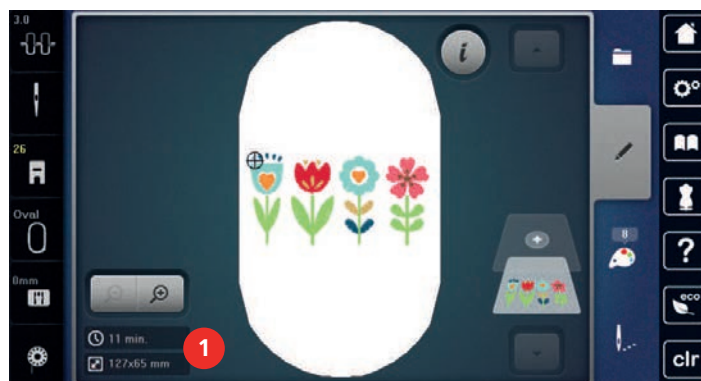

5.4 Geschwindigkeit regulieren

Mit dem Geschwindigkeitsregler kann die Geschwindigkeit stufenlos angepasst werden.

- > Um die Geschwindigkeit zu reduzieren, Geschwindigkeitsregler nach links schieben.
- > Um die Geschwindigkeit zu erhöhen, Geschwindigkeitsregler nach rechts schieben.

5.5 Stickmuster bearbeiten

Übersicht Stickmuster bearbeiten

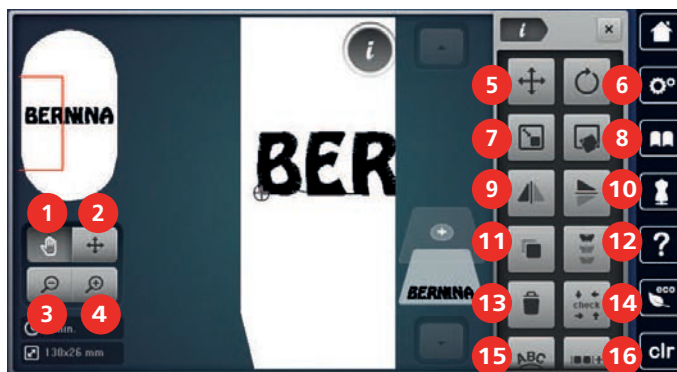

- | | | | |
|---|------------------------------|----|---|
| 1 | «Ansicht verschieben» | 10 | «Spiegeln oben/unten» |
| 2 | «Stickmuster verschieben» | 11 | «Duplizieren» |
| 3 | «Ansicht verkleinern» | 12 | «Bordüren sticken» |
| 4 | «Ansicht vergrößern» | 13 | «Stickmuster löschen» |
| 5 | «Stickmuster verschieben» | 14 | «Stickmustergröße kontrollieren» |
| 6 | «Stickmuster drehen» | 15 | «WordArt»
(nach Texteingabe aktiv) |
| 7 | «Stickmustergröße verändern» | 16 | «Stickmuster gruppieren» |
| 8 | «Punktgenaue Platzierung» | 17 | «Reihenfolge der Stickmusterkombination ändern»
(wird durch Scrollen sichtbar) |
| 9 | «Spiegeln links/rechts» | 18 | «Stichart/Stickdichte verändern»
(wird durch Scrollen sichtbar) |

Stickmusteransicht vergrößern

Die Ansicht des Stickmusters kann vergrößert werden. Darüber hinaus kann die Ansicht ohne oder mit Änderung der Stickposition angepasst werden.

> Stickmuster wählen.



> Um die Ansicht des Stickmusters zu bearbeiten, «Ansicht vergrößern» antippen.



> Um die Stickmusteransicht um je eine Stufe zu vergrößern, «Ansicht vergrößern» 1 bis 4x antippen.



> Um in den Bearbeitungsmodus zurückzugelangen, «Ansicht verkleinern» 1 bis 4x antippen.

Stickmusteransicht verkleinern

Die Ansicht des Stickmusters kann verkleinert werden. Darüber hinaus kann die Ansicht ohne oder mit Änderung der Stickposition angepasst werden.

> Stickmuster wählen.



> Um die Ansicht des Stickmusters zu bearbeiten, «Ansicht vergrößern» antippen.



> Um die vergrößerte Stickmusteransicht um je eine Stufe zu verkleinern, «Ansicht verkleinern» 1 – 4x antippen.

Stickmusteransicht verschieben

Die Ansicht des Stickmusters kann verschoben werden. Darüber hinaus kann die Ansicht ohne oder mit Änderung der Stickposition angepasst werden.

> Stickmuster wählen.

Stickmustergrösse proportional ändern



Für eine optimale Stickqualität, ist eine Änderung der Stickmustergrösse um maximal 20 % empfohlen. Wenn die Stickmustergrösse um mehr als 20 % verändert werden soll, sollte das Stickmuster in einer separaten Sticksoftware angepasst und neu auf die Maschine geladen werden.



- > Stickmuster wählen.
- > «i-Dialog» antippen.



- > «Stickmustergrösse verändern» antippen.



- > Wenn «Proportionen beibehalten» nicht weiss umrandet ist, «Proportionen beibehalten» antippen.
 - «Proportionen beibehalten» ist weiss umrandet.



- > Um das Stickmuster zu vergrössern, «Multifunktionsknopf oben/unten» nach rechts drehen.
- > Um das Stickmuster zu verkleinern, «Multifunktionsknopf oben/unten» nach links drehen.

Stickmustergrösse unproportional ändern



Für eine optimale Stickqualität, ist eine Änderung der Stickmustergrösse um maximal 20 % empfohlen. Wenn die Stickmustergrösse um mehr als 20 % verändert werden soll, sollte das Stickmuster in einer separaten Sticksoftware angepasst und neu auf die Maschine geladen werden.



- > Stickmuster wählen.
- > «i-Dialog» antippen.



- > «Stickmustergrösse verändern» antippen.



- > Wenn «Proportionen beibehalten» weiss umrandet ist, «Proportionen beibehalten» antippen.
 - «Proportionen beibehalten» ist nicht weiss umrandet.



- > Um das Stickmuster breiter zu machen, «Multifunktionsknopf oben» nach rechts drehen.

- > Um das Stickmuster schmaler zu machen, «Multifunktionsknopf oben» nach links drehen.
- > Um das Stickmuster länger zu machen, «Multifunktionsknopf unten» nach rechts drehen.
- > Um das Stickmuster kürzer zu machen, «Multifunktionsknopf unten» nach links drehen.

Stickmuster spiegeln

Stickmuster können sowohl vertikal/senkrecht als auch horizontal/waagrecht gespiegelt werden.

- > Stickmuster wählen.
- > «i-Dialog» antippen.



- > Um das Stickmuster horizontal zu spiegeln, «Spiegeln links/rechts» antippen.



- > Um das Stickmuster vertikal zu spiegeln, «Spiegeln oben/unten» antippen.

Stichart ändern

Sind Satinstiche zu lang, können diese in Steppstiche umgewandelt werden.

- > Stickmuster wählen.
- > «i-Dialog» antippen.



- > «Stichart/Stickdichte verändern» antippen.



- > Um den Satinstich in den Steppstich umzuwandeln, Schalter im oberen Bereich des Displays (1) antippen.
- > Stichlänge (2) einstellen und bestätigen.

Stickdichte ändern

Sind Satinstiche zu dicht gestickt, kann die Stickdichte angepasst werden.

- > Stickmuster wählen.
- > «i-Dialog» antippen.



- > «Stichart/Stickdichte verändern» antippen.



- > Stickdichte (1) einstellen.

Stickmustergröße und -position prüfen

Es kann geprüft werden, ob das Stickmuster auf die vorgesehene Position/Ort des Stoffes passt. Punkte, die ausserhalb des Stickrahmens liegen, werden nicht angefahren.

- > Stickmuster wählen.
- > «i-Dialog» antippen.



- > «Stickmustergröße kontrollieren» antippen.
 - Stickrahmen fährt soweit, bis die Nadel auf der Position, wie im Display dargestellt, steht.

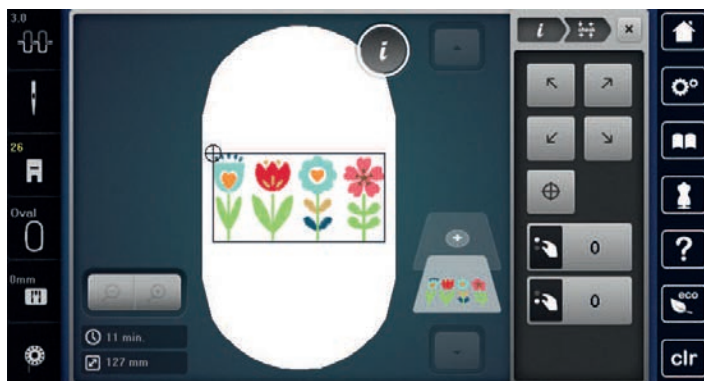

- > Um die gewünschte Ecke des Stickmusters anzuwählen, entsprechenden Pfeil antippen.
 - Der Stickrahmen fährt soweit, bis die Nadel auf der im Display dargestellten Position steht. Ist das Stickmuster noch nicht korrekt positioniert, kann die Position über die «Multifunktionsknöpfe oben/unten» verändert werden und die gesamten Stickmusterpositionen erneut geprüft werden.



- > Um die Nadel in die Mitte des Stickmusters zu fahren, «Stickmustermitte» antippen.
- > Um das Stickmuster horizontal zu verschieben, «Multifunktionsknopf oben» drehen.
- > Um das Stickmuster vertikal zu verschieben, «Multifunktionsknopf unten» drehen.

Bordüren sticken

Für das Sticken einer Bordüre ist es von Vorteil, den Mega-Stickrahmen (Sonderzubehör) oder Maxi-Stickrahmen (Sonderzubehör) zu verwenden. Das Stickprojekt muss dann nicht so häufig umgespannt werden. Es ist zu empfehlen, auf dem Stoff Hilfslinien einzuzeichnen und beim Ein- und Umspannen in den Rahmen die Schablone zu verwenden. Die Hilfslinien müssen dabei parallel zu den Linien der Schablone verlaufen. Im nachfolgenden Beispiel wird der mitgelieferte Rahmen verwendet.

- > Stickmuster wählen.
- > «i-Dialog» antippen.



- > «Bordüren sticken» antippen.
 - Das Stickmuster wird in der optimalen Anzahl, passend zum Stickrahmen, dupliziert.
 - Die Referenzpunkte, nötig beim Umspannen des Stoffes, werden eingefügt.

- > Mit den Pfeilfeldern (1) bei Bedarf weitere Referenzpunkte einfügen.
- > Um die Stickmusteranzahl einzustellen, «Minus»/«Plus» (2) antippen.
- > Um den Abstand zwischen den Stickmustern einzustellen, «Minus»/«Plus» (3) antippen.



- > Um alle Stickmuster automatisch in den Stickrahmen einzupassen, «Stickmustergröße dem Rahmen anpassen» (4) antippen.

- > «Bestätigen» antippen.

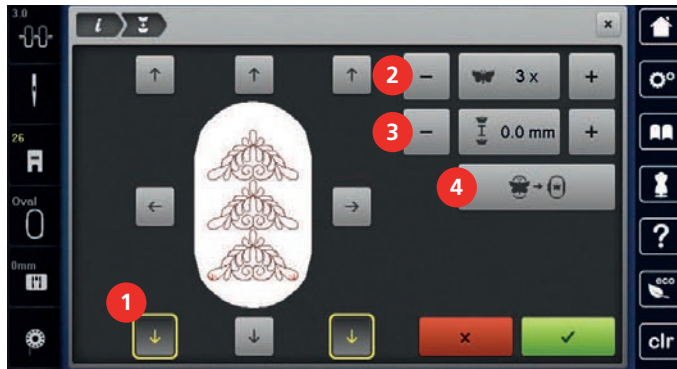

- > «i-Dialog» antippen.



- > «Sticken» antippen.



- > Taste «Start/Stop» drücken und die Bordüre aussticken.
 - Das Stickmuster muss fertig ausgestickt sein.

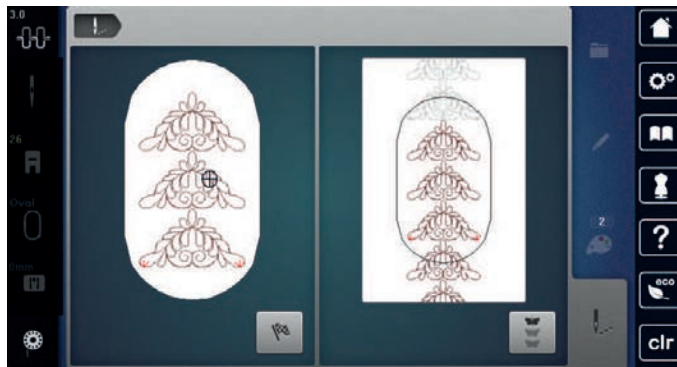

- > Wenn die Referenzpunkte gestickt wurden, «Bordüren sticken» antippen.
 - Eine Animation zeigt an, dass der Stoff umgespannt werden muss.

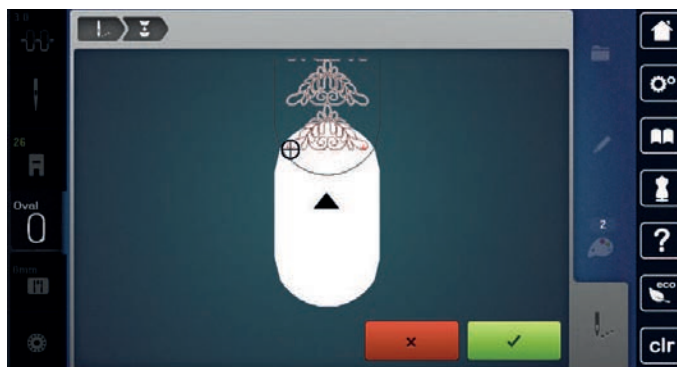

- > Stickrahmen entfernen und Stoff so umspannen, dass sich die ausgestickten Referenzpunkte im oberen Stickbereich des Stickrahmens befinden und die Referenzpunkte mindestens 3 cm (1.18 inch) vom oberen Rand des Stickrahmens entfernt liegen.
- > Stickrahmen montieren.
- > «Bestätigen» antippen.
 - Stickrahmen wird automatisch in die Nähe des Referenzpunktes verschoben.
 - Feld «AUTO» ist aktiv und der Stickrahmen bewegt sich automatisch in die Nähe des letzten Referenzpunktes.
- > Mit den Pfeilfeldern bestimmen, auf welcher Seite des gestickten Teils der nächste Referenzpunkt platziert werden soll.

- > Um den Stickrahmen genau zu positionieren, «Multifunktionsknopf oben» oder «Multifunktionsknopf unten» drehen.

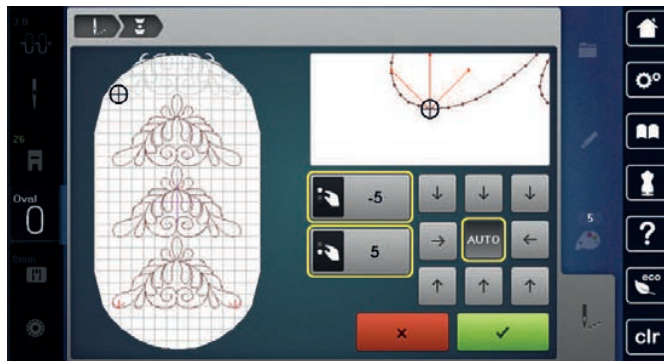

- ✓ > «Bestätigen» antippen.
- ⏻ > Taste «Start/Stop» drücken und weitersticken.
- > Diese Schritte wiederholen, bis die gewünschte Länge der Bordüre erreicht ist.

Stickmuster duplizieren

- > Stickmuster wählen.
- ⓘ > «i-Dialog» antippen.
- 📄 > «Duplizieren» antippen.
 - Das Stickmuster (1) wird verdoppelt (2).

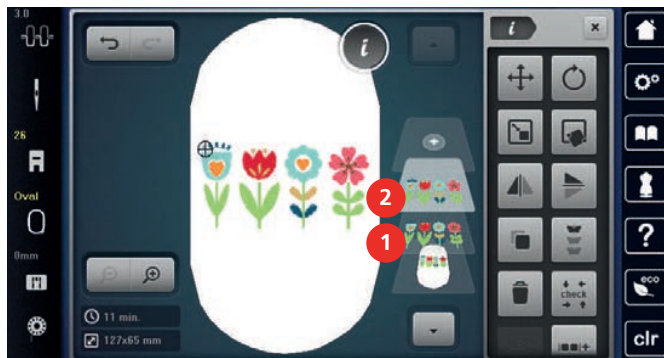

Stickmuster löschen

Aktives Stickmuster wird gelöscht.

- > Stickmuster wählen.
- ⓘ > «i-Dialog» antippen.
- 🗑️ > «Löschen» antippen.

Reihenfolge der Stickmusterkombination ändern

Die Reihenfolge der Stickmuster in der Stickmusterkombination kann geändert werden.

Voraussetzung:

- Stickmusterkombination ist erstellt oder das Muster ist ungruppiert.

- ⓘ > «i-Dialog» antippen.
- 🔄 > «Reihenfolge der Stickmusterkombination ändern» antippen.
- > Gewünschtes Stickmuster anwählen und an die entsprechende Position verschieben.

Eingaben rückgängig machen

Alle Eingaben können schrittweise rückgängig gemacht und ebenso wiederhergestellt werden.

Voraussetzung:

- Ein Stickmuster ist gewählt und Änderungen wurden vorgenommen.



- > Um die letzte Eingabe rückgängig zu machen, «Eingaben rückgängig machen» antippen.
- > Um die letzten Eingaben der Reihe nach rückgängig zu machen, «Eingaben rückgängig machen» mehrmals antippen.



- > Um die letzte Eingabe wiederherzustellen, «Eingaben wiederherstellen» antippen.
- > Um die letzten Eingaben der Reihe nach wiederherzustellen, «Eingaben wiederherstellen» mehrmals antippen.

Stickmuster gruppieren

Stickmuster können zu einer Gruppe hinzugefügt oder aus der Gruppe entfernt werden. Die gruppierten Stickmuster können wie ein Stickmuster bearbeitet werden.

Die Reihenfolge der Stickmuster in der Gruppe kann geändert werden. (siehe Seite 66)

Wenn die Gruppierung eines Stickmusters aufgelöst wurde, sprich das Stickmuster in verschiedene Elemente/Farben zerlegt wurde, werden die Farben beim erneuten Gruppieren nicht mehr zusammengelegt. Bei Alphabeten muss zuerst die Länge der Verbindungsstiche im Setup auf 1 gesetzt werden. Dann funktioniert das Auflösen der Gruppe bei allen Buchstaben.

- > Stickmusterkombination erstellen.
- > Stickmuster (1) in der Stickmusterkombination wählen.

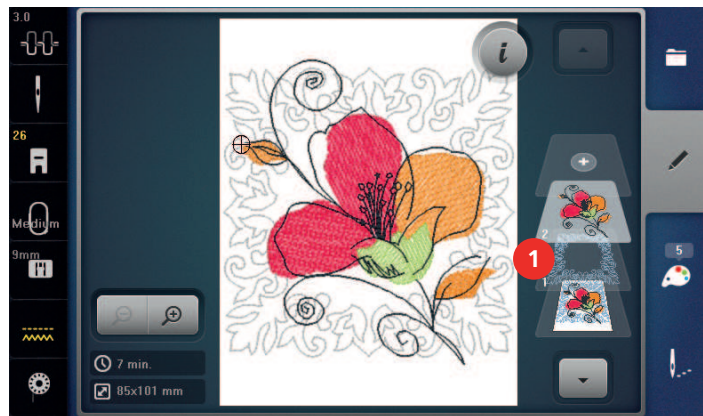

- > «i-Dialog» antippen.



- > «Stickmuster gruppieren» antippen.



- > «Gruppieren» antippen.
 - Stickmuster oberhalb des angewählten Stickmusters wird der Stickmustergruppe hinzugefügt.
- > Stickmustergruppe wählen.



- > «Gruppe aufheben» antippen.
 - Die Gruppierung wird aufgehoben.

oder

- > Stickmusterkombination erstellen.

- > Alle Stickmuster (2) wählen.

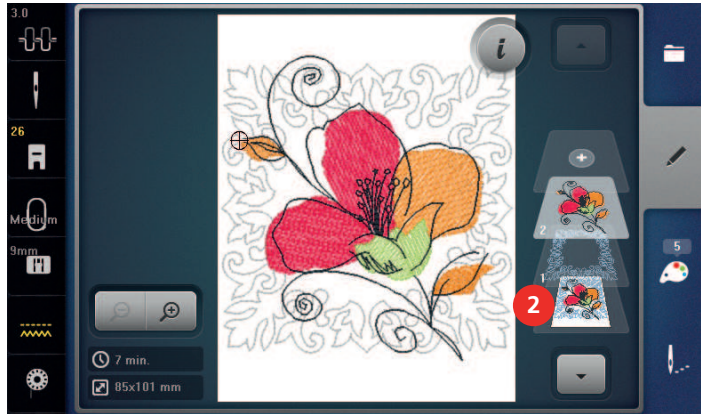

- > «i-Dialog» antippen.



- > «Gruppieren» antippen.
 - Alle Stickmuster werden der Stickmustergruppe hinzugefügt.
- > Stickmustergruppe wählen.



- > «Gruppe aufheben» antippen.
 - Die Gruppierung wird aufgehoben.

5.6 Punktgenaue Platzierung

Rasterpunktpositionierung

Mit dieser Funktion können Stickmuster auf einfache Weise exakt auf dem Stoff positioniert werden. Die Positionspunkte können auf dem Raster gesetzt werden.

Voraussetzung:

- Zwei beliebige Punkte des Stickmusters sind mit einem Kreidestift oder einem wasserlöslichen Stift auf dem Stoff markiert. Der Bereich oder Ort an dem das Stickmuster positioniert werden soll, ist klar erkennbar.
- Der verwendete Stickrahmen ist angewählt.

- > Stickmuster wählen.
- > «i-Dialog» antippen.



- > «Punktgenaue Platzierung» antippen.



- > «Rasterpunktpositionierung» antippen.
 - Das Stickmuster erhält einen Raster mit neun verschiedenen Ortungs-/Positionierungspunkten.
- > Gewünschten Positionierungspunkt wählen, an dem das Stickmuster ausgerichtet werden soll.
 - Der Punkt wechselt Farbe.

- > Um die Nadel über die entsprechende Markierung auf dem Stoff zu positionieren, «Multifunktionsknopf oben» oder «Multifunktionsknopf unten» nach links oder rechts drehen.



- > Um die veränderte Position zu bestätigen, «Set» antippen.
 - Der Punkt wechselt die Farbe und wird festgesetzt.
- > Zweiten Positionierungspunkt des Stickmusters wählen.

- > Um die Nadel über die entsprechende Markierung auf dem Stoff zu positionieren, «Multifunktionsknopf oben» oder «Multifunktionsknopf unten» nach links oder rechts drehen.

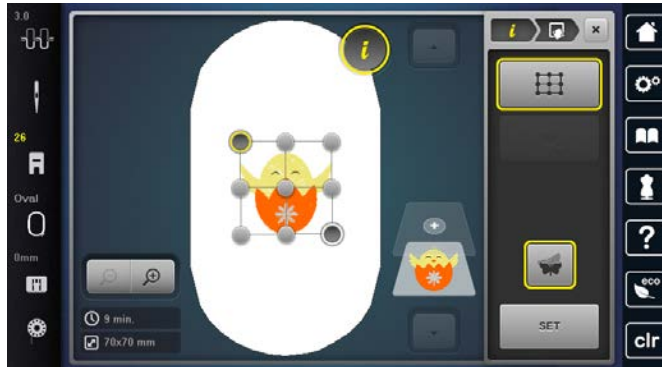

- > Um die veränderte Position zu bestätigen, «Set» antippen.
 - Der Punkt wechselt die Farbe und wird festgesetzt. Das Stickmuster wird entsprechend angepasst.
- > Um die Änderungen auf Grundeinstellung zurückzusetzen, «Punktgenaue Platzierung zurücksetzen» antippen.



Freie Punktepositionierung

Mit dieser Funktion können Stickmuster auf einfache Weise exakt auf dem Stoff positioniert werden. Die Punkte können frei innerhalb des Stickmusters gesetzt werden.

Voraussetzung:

- Zwei beliebige Punkte des Stickmusters sind mit einem Kreidestift oder einem wasserlöslichen Stift auf dem Stoff markiert. Der Bereich oder Ort an dem das Stickmuster positioniert werden soll, ist klar erkennbar.
- Der verwendete Stickrahmen ist angewählt.

- > Stickmuster wählen.
- > «i-Dialog» antippen.



- > «Punktgenaue Platzierung» antippen.



- > «Freie Punktepositionierung» antippen.
- > Einen gewünschten Punkt innerhalb des Stickmusters setzen.
 - Der Positionierungspunkt wird angezeigt.
- > Um die Nadel über die entsprechende Markierung auf dem Stoff zu positionieren, «Multifunktionsknopf oben» oder «Multifunktionsknopf unten» nach links oder rechts drehen.



- > Um die veränderte Position zu bestätigen, «Set» antippen.
 - Der Punkt wechselt die Farbe und wird festgesetzt.
- > Zweiten Positionierungspunkt des Stickmusters wählen.
- > Um die Nadel über die entsprechende Markierung auf dem Stoff zu positionieren, «Multifunktionsknopf oben» oder «Multifunktionsknopf unten» nach links oder rechts drehen.



- > Um die veränderte Position zu bestätigen, «Set» antippen.
 - Der Punkt wechselt die Farbe und wird festgesetzt. Das Stickmuster wird entsprechend angepasst.



- > Um die Änderungen auf Grundeinstellung zurückzusetzen, «Punktgenaue Platzierung zurücksetzen» antippen.

5.7 Stickmuster kombinieren

Stickmuster kombinieren

Im Kombinationsmodus können mehrere Stickmuster kombiniert werden.

- > Stickmuster wählen.
- > «Stickmuster hinzufügen» antippen.



- > Weiteres Stickmuster wählen.

Einzelnes Stickmuster löschen

Voraussetzung:

- Eine Stickmusterkombination ist erstellt.
- > Gewünschtes Stickmuster im Bereich der Stickmusterebene (1) antippen, gedrückt halten und nach aussen schieben.
 - Ein neues Fenster wird geöffnet.

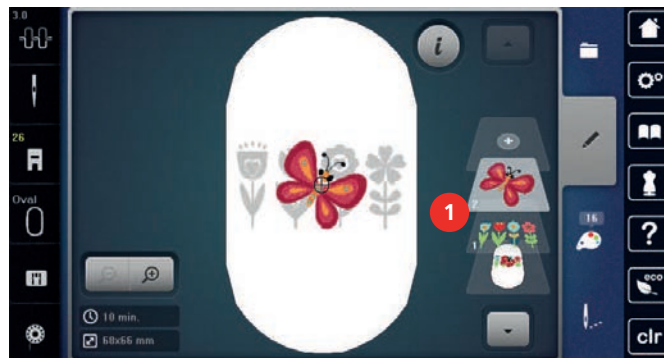

- > Um das ausgewählte Stickmuster zu löschen, «Bestätigen» antippen.

Stickmuster duplizieren

- > Stickmuster wählen.
- > «i-Dialog» antippen.



- > «Duplizieren» antippen.
 - Das Stickmuster (1) wird verdoppelt (2).

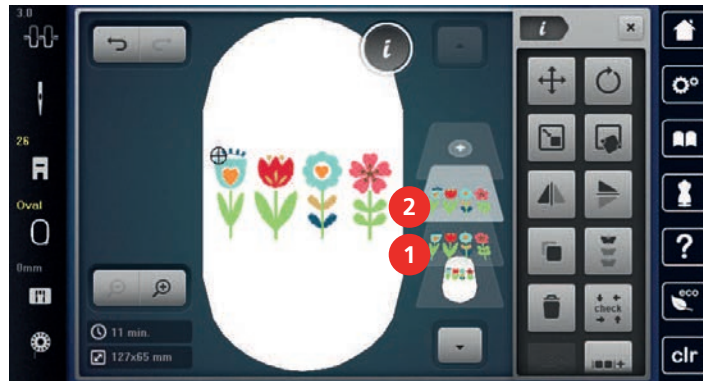

Kombination duplizieren

Wenn eine Kombination dupliziert wird, können die einzelnen Stickmuster nicht mehr ausgewählt werden.

- > Stickmuster wählen.
- > «Stickmuster hinzufügen» antippen.
- > Weiteres Stickmuster wählen.
- > Kombination (1) wählen.

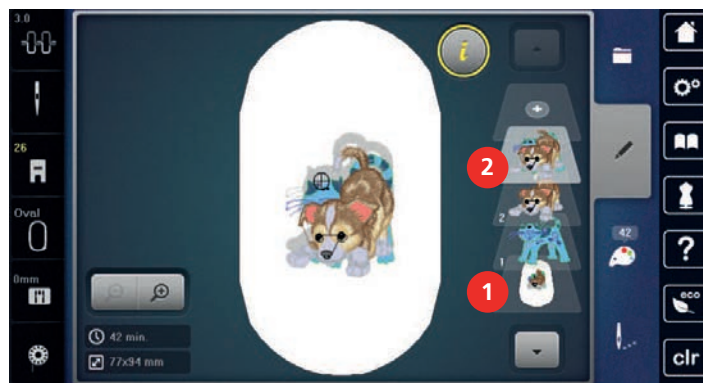

- > «i-Dialog» antippen.
- > «Duplizieren» antippen.
 - Die Kombination wird verdoppelt (2).



5.8 Schriftzug erstellen

Übersicht Stickalphabete

Stickmuster		Name
ABC	A B C	Drifter
ABC	A B C	Childs Play
ABC		Victoria

Stickmuster		Name
ABC		Condensed Sans
ABC		Flare Serif
ABC		Deco block
<i>ABC</i>		Curly
ABC		Rounded Sans
<i>ABC</i>	<i>A B C</i>	Anniversary
ABC		Bamboo
<i>ABC</i>		Lisa
<i>ABC</i>		Zürich
ABC	A B C	Swiss Block
ABC		Quilt Block
ABC		Old English
АВВ	A B B	Russian Textbook
ABC		Happy Times
ABC		Chicago

Schriftzug erstellen



- | | | | |
|---|----------------|---|------------------------------------|
| 1 | Eingabefeld | 5 | «Zahlen und mathematische Zeichen» |
| 2 | «Löschen» | 6 | «Sonderzeichen» |
| 3 | «Grossschrift» | 7 | «Abbrechen» |
| 4 | «Kleinschrift» | 8 | «Bestätigen» |



Ein Schriftzug wird immer in einer Farbe gestickt. Um einzelne Buchstaben oder einzelne Wörter in einer anderen Farbe zu sticken, muss die Gruppierung aufgehoben werden.

Ein Schriftzug kann innerhalb des Stickrahmens beliebig positioniert werden. Wenn das Stickmuster ausserhalb des Stickbereichs positioniert ist, wird der Stickrahmen auf dem Display rot umrandet. Mithilfe der Stickrahmenauswahl kann geprüft werden, ob das Stickmuster mit einem anderen Stickrahmen ausgestickt werden kann. Wenn ein Schriftzug nicht in einen Stickrahmen passt, können zum Beispiel einzelne Wörter miteinander kombiniert und untereinander positioniert werden.



- > «Alphabete» wählen.
- > Stickalphabet wählen.
- > Text eingeben und bestätigen.

Schriftzug bearbeiten



- > Ein Schriftzug ist erstellt.
- > «i-Dialog» antippen.



- > «WordArt» antippen.
- > Um den Abstand zwischen den Zeichen in Millimeterschritten zu ändern, «Multifunktionsknopf oben» drehen.
- > Um den Schriftzug nach oben oder nach unten zu biegen, «Multifunktionsknopf unten» nach links oder rechts drehen.

5.9 Stickmusterfarben ändern

Übersicht Farben ändern







- | | | | |
|---|----------------------------|---|---------------------------|
| 1 | «Farbanzeige» | 4 | «Fadenmarke zuweisen» |
| 2 | Vorschau ausgewählte Farbe | 5 | «Farbe/Hersteller ändern» |
| 3 | «Farbrad» | 6 | «Farbinformationen» |

Farben ändern



Ein Schriftzug wird immer in einer Farbe gestickt. Um einzelne Buchstaben oder einzelne Wörter in einer anderen Farbe zu sticken, muss die Gruppierung aufgehoben werden.

- > Stickmuster wählen.
 - > «Farbinformationen» antippen.
- 
- > «Farbe/Hersteller ändern» neben der Farbe antippen, die geändert werden soll.
- 
- > Um die Farbe durch Eingabe der Farbnummer auszuwählen, «Farbenwahl durch Nummer» antippen.
 - > Gewünschte Farbe auswählen.
- 
- > Um die Farbwahl zu übernehmen, «Farbinformationen» antippen.
- 

Farben mit dem Farbrad ändern



- > «Farbinformationen» antippen.
- > «Farbrad» (1) antippen.

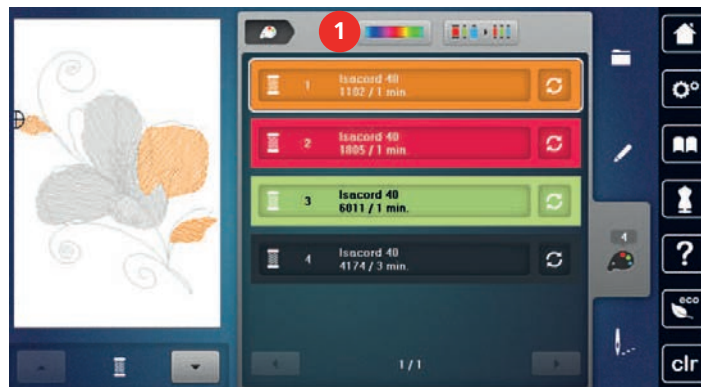

- > Um die Farben des Stickmusters zu verändern, Knopf (2) im Uhrzeigersinn oder entgegen dem Uhrzeigersinn drehen.

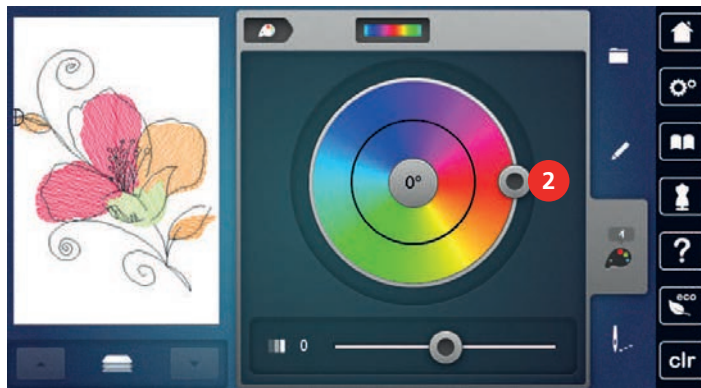

- > Um die Änderungen rückgängig zu machen, auf den Wert in der Mitte des Farbkreises tippen.
- > Um die Helligkeit der Farben zu verändern, Schieber (3) verschieben.

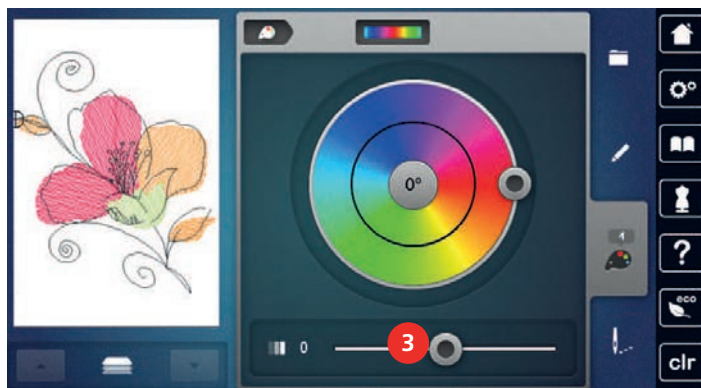

- > «Bearbeiten» antippen.
 - Die Einstellungen werden übernommen und das Stickmuster mit den neuen Farben ist sichtbar.

Fadenmarke ändern



- > Stickmuster wählen.
- > «Farbinformationen» antippen.



- > «Farbe/Hersteller ändern» antippen.
- > Um weitere Fadenmarken anzuzeigen, nach links und rechts scrollen.



- > «Fadenmarke zuweisen» antippen.
 - Alle Fadenfarben des gewählten Stickmusters werden in die ausgewählte Fadenmarke umgeändert.



5.10 Stickmuster sticken

Übersicht Stickmenü

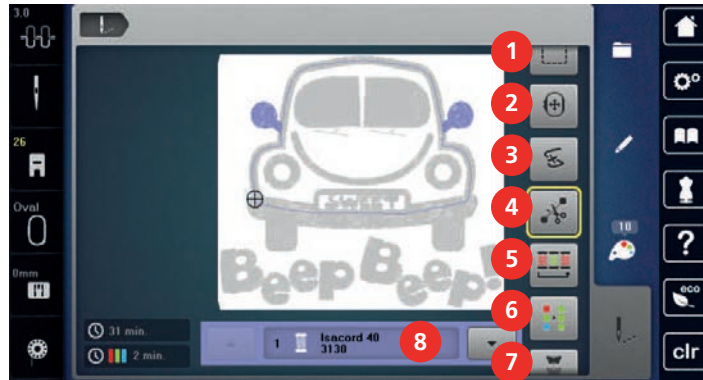

- | | | | |
|---|-------------------------------|---|------------------------------------|
| 1 | «Heften» | 5 | «Farbwechsel reduzieren» |
| 2 | «Stickrahmen verschieben» | 6 | «Mehrfarbiges Stickmuster ein/aus» |
| 3 | «Stickablaufkontrolle» | 7 | «Bordüren sticken» |
| 4 | «Verbindungsstiche schneiden» | 8 | «Farbanzeige» |

Heftstiche hinzufügen

Die Heftstiche können entlang des Stickrahmens oder des Stickmusters gestickt werden. Dadurch erhalten Stoff und Stickvlies eine bessere Verbindung.

- > Stickmuster wählen.
- > «Sticken» antippen.



- > Um die Heftstiche entlang des Stickmusters zu sticken, «Heften» antippen.
- > Um die Heftstiche entlang des Stickrahmens zu sticken, «Heften» erneut antippen.
- > Um die Heftstiche auszuschalten, «Heften» erneut antippen.

Stickrahmen verschieben

Ist ein Stickmuster so gross, dass ein wiederholtes Einspannen nötig ist, kann das Stickmuster nochmals verschoben werden.

- > Stickmuster wählen.
- > «Sticken» antippen.



- > «Stickrahmen verschieben» antippen.
- > Um den Stickrahmen horizontal zu verschieben, «Multifunktionsknopf oben» drehen.
- > Um den Stickrahmen vertikal zu verschieben, «Multifunktionsknopf unten» drehen.
- > Um die Einstellungen zu übernehmen, «Sticken» in der Verlaufsnavigation antippen.



Stickablaufkontrolle bei Fadenbruch

Wenn der Faden reisst, kann mithilfe der Stickablauf-Kontrollfunktion die Nadel im Stickmuster neu positioniert werden.

- > Stickmuster wählen.
- > «Sticken» antippen.





- > «Bordüren sticken» antippen.

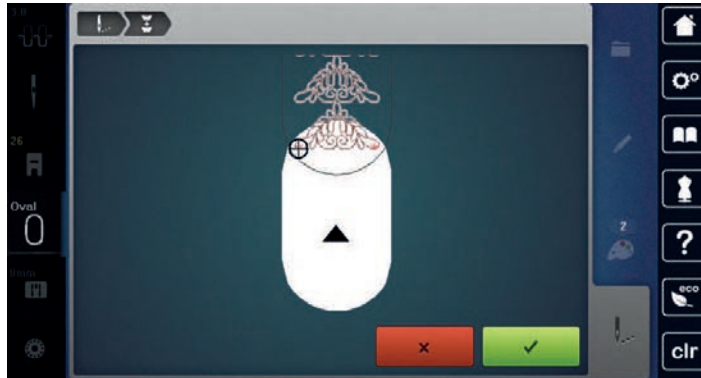

- > Stickrahmen entfernen und Stoff so umspannen, dass sich die ausgestickten Referenzpunkte im oberen Stickbereich des Stickrahmens befinden und die Referenzpunkte mindestens 3 cm (1.18 inch) vom oberen Rand des Stickrahmens entfernt liegen.
- > Stickrahmen montieren.
- > «Bestätigen» antippen.
 - Stickrahmen wird automatisch in die Nähe des letzten Sticks verschoben.
 - Feld «AUTO» ist aktiv und der Stickrahmen bewegt sich automatisch in die Nähe des letzten Referenzpunkts.
- > Mit den Pfeilfeldern bestimmen, auf welcher Seite des gestickten Teils der nächste Referenzpunkt platziert werden soll.
- > Um den Stickrahmen genau zu positionieren, «Multifunktionsknopf oben» oder «Multifunktionsknopf unten» drehen.

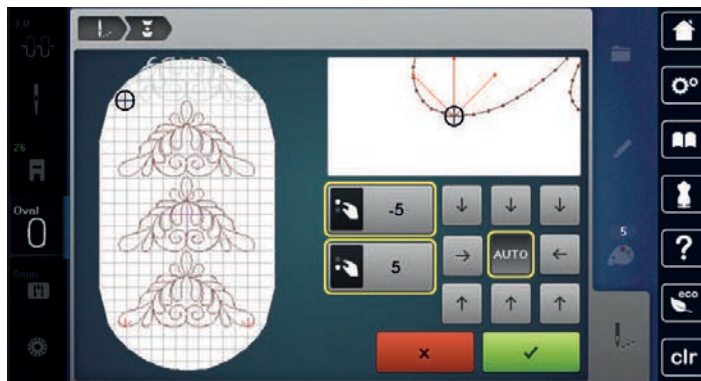

- > «Bestätigen» antippen.



- > Taste «Start/Stop» drücken und weitersticken.
- > Diese Schritte wiederholen, bis die gewünschte Länge der Bordüre erreicht ist.

Farbanzeige

Jede Farbe eines Stickmusters kann einzeln angewählt werden. Der Stickrahmen bewegt sich dann zum ersten Stich der aktiven Farbe. Die jeweils aktive Farbe kann so auch einzeln oder in anderer Reihenfolge ausgestickt werden.



- > Stickmuster wählen.
- > «Sticken» antippen.
- > Um die nächste oder vorherige Farbe des Stickmusters zu wählen, nach oben und unten scrollen.

5.11 Freiarmsticken

Unter Freiarmsticken versteht man das Besticken von schlauchartigen Stoffen oder Kleidungsstücken, die während des Stickens um den Freiarm der Stickmaschine liegen. Häufig angewendet bei Ärmel, Hosenbeinen oder sonstigen schmal geschnittenen Kleidungsstücken.



Ein Stoffschlauch lässt sich bequem um den Freiarm der Maschine legen, wenn vor der Befestigung oder Entfernung des Stickrahmens dieser nach links in die Parkposition gefahren wird. Um den Stickrahmen anschliessend wieder in Stickposition zu bringen, Taste «Start/Stop» drücken.

Wenn möglich eine volle Unterfadenspule verwenden, da beim Wechseln der Spule der Stickrahmen entfernt werden muss.

Bordüren können einfach und exakt der Schlauchkante entlang zu einem Ring geschlossen werden. Vor dem Ausarbeiten des letzten Stickmusters, nach dem Umspannen des Stoffs, die Funktion «Punktgenaue Platzierung» im Bearbeitungsmodus aktivieren. Mit der Unterfunktion «Freie Punktepositionierung» das noch fehlende Stickmuster passgenau einfügen.

Die Beweglichkeit des Stickarms kann bei sehr engen Stoffschläuchen eingeschränkt oder behindert werden. Daher ist darauf zu achten, dass sich der Stickrahmen während des Stickens ausreichend vor und zurück bewegen kann. Eine Behinderung des Stickarms durch einen zu engen Stoffschlauch kann zu Stickmustersersatz und zu Beschädigungen des Stoffes führen.

Beweglichkeit des Stickarms prüfen

Hinweis: Bei kleinem Stoffschlauch evtl. die Faden-Entfernung im Setup-Programm abschalten.

- > Stickmuster an der Maschine öffnen und wie gewünscht bearbeiten.
- > Stickmusterposition und -grösse auf dem Stoff in geeigneter Weise markieren.
- > Stickrahmen so klein wie möglich wählen.
- > Stoff mit passender Stickunterlage im Stickrahmen einspannen oder aufkleben, je nach Stickunterlage.
- > Stoffschlauch vorsichtig um den Freiarm der Maschine schieben und Stickrahmen an der Kupplung des Stickmoduls befestigen.
- > Falls erforderlich, Stickmusterposition korrigieren.
- > «Stickmustergrösse kontrollieren» antippen.
- > Nach erfolgreichem Prüfen der Stickmustergrösse den Stickvorgang starten.



5.12 Stickmuster verwalten

Übersicht Stickmuster verwalten

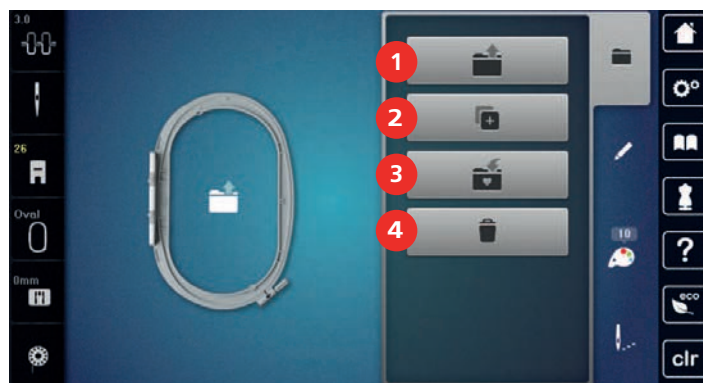



- | | | | |
|---|--------------------------|---|-------------------------|
| 1 | «Stickmuster laden» | 3 | «Stickmuster speichern» |
| 2 | «Stickmuster hinzufügen» | 4 | «Stickmuster löschen» |

Stickmuster im eigenen Speicher speichern





In der Ablage «Stickmuster speichern» können beliebige und auch individuell veränderte Stickmuster abgespeichert werden.

- > Stickmuster wählen.
- > Stickmuster bearbeiten.
- > «Auswahl» antippen.







-  > «Stickmuster speichern» antippen.
 - Das zu speichernde Stickmuster ist gelb umrandet.
-  – «Stickmaschine» ist aktiv.
-  > «Bestätigen» antippen.





Stickmuster auf dem BERNINA USB-Stick speichern

- > Stickmuster wählen.
- > Stickmuster bearbeiten.
-  > «Auswahl» antippen.
-  > «Stickmuster speichern» antippen.
 - Das zu speichernde Stickmuster ist gelb umrandet.
- > BERNINA USB-Stick in den USB-Anschluss der Maschine einstecken.
-  > «USB-Stick» antippen.
-  > «Bestätigen» antippen.



Stickmuster im eigenen Speicher überschreiben

- > Stickmuster wählen.
- > Stickmuster bearbeiten.
-  > «Auswahl» antippen.
-  > «Stickmuster speichern» antippen.
 - Das zu speichernde Stickmuster ist gelb umrandet.
-  – «Stickmaschine» ist aktiv.
- > Stickmuster wählen, welches überschrieben werden soll.
-  > «Bestätigen» antippen.



Stickmuster auf dem BERNINA USB-Stick überschreiben

- > Stickmuster wählen.
- > Stickmuster bearbeiten.
-  > «Auswahl» antippen.
-  > «Stickmuster speichern» antippen.
 - Das zu speichernde Stickmuster ist gelb umrandet.
- > BERNINA USB-Stick in den USB-Anschluss der Maschine einstecken.
-  > «USB-Stick» antippen.
- > Stickmuster wählen, das überschrieben werden soll.
-  > «Bestätigen» antippen.

Stickmuster aus dem eigenen Speicher laden





-  > «Auswahl» antippen.
-  > «Stickmuster laden» antippen.
-  > «Eigene Stickmuster» wählen.
- > Stickmuster wählen.

Stickmuster vom BERNINA USB-Stick laden





-  > «Auswahl» antippen.
- > BERNINA USB-Stick in den USB-Anschluss der Maschine einstecken.
-  > «Stickmuster laden» antippen.
-  > «USB-Stick» antippen.
- > Eigenes Stickmuster wählen.

Stickmuster aus dem eigenen Speicher löschen

Die im eigenen Speicher gesicherten Stickmuster lassen sich einzeln löschen.

-  > «Auswahl» antippen.
-  > «Löschen» antippen.
-  – «Stickmaschine» ist aktiv.
- > Stickmuster wählen, das gelöscht werden soll.
-  > «Bestätigen» antippen.

Stickmuster vom BERNINA USB-Stick löschen

-  > «Auswahl» antippen.
-  > «Löschen» antippen.
- > BERNINA USB-Stick in den USB-Anschluss der Maschine einstecken.
-  > «USB-Stick» antippen.
- > Stickmuster wählen, das gelöscht werden soll.
-  > «Bestätigen» antippen.

6 Sticken

6.1 Sticken mit Taste «Start/Stopp»

Bei Stromausfall wird der Stickprozess unterbrochen. Die Maschine fährt nach einem Neustart die zuletzt gestickte Position an.

- > Taste «Start/Stopp» drücken, bis die Stickmaschine startet.
 - Alle Musterteile der aktiven Farbe werden fertig gestickt.
 - Die Stickmaschine stoppt am Ende automatisch.
 - Beide Fäden werden automatisch abgeschnitten.
 - Die Stickmaschine stellt automatisch auf die nächste Farbe um.
- > Oberfadenfarbe wechseln.
- > Um die neue Farbe zu sticken, Taste «Start/Stopp» drücken.
- > Nach der Fertigstellung des Stickmusters mit dem Feld «Stickprozess beenden» (1) den Stickprozess beenden, oder mit dem Feld «Bordüren sticken» (2) das Stickmuster als Bordüre erneut aussticken.

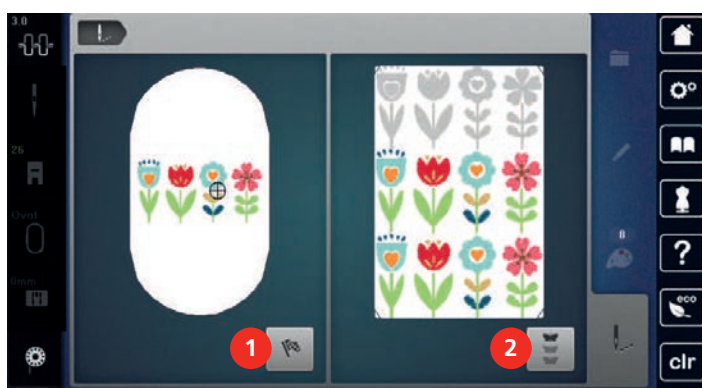

6.2 Stickgeschwindigkeit erhöhen

Um die beste Stickqualität zu gewährleisten, wird die Geschwindigkeit beim Sticken, je nach Stickposition, reduziert. Es besteht die Möglichkeit, zwischen optimaler und maximaler Geschwindigkeit zu wählen. Standard = optimale Geschwindigkeit. Es ist zu beachten, dass die Qualität des ausgestickten Stickmusters bei Maximalgeschwindigkeit nicht garantiert werden kann.

Durch Aus- und Einschalten der Maschine wird die optimale Stickgeschwindigkeit aktiviert.

Voraussetzung:

- Das Aussticken ist gestartet.
- 🐾 > «Stickgeschwindigkeit» antippen.
 - Die maximale Geschwindigkeit wird aktiviert.
- 🐾 > «Stickgeschwindigkeit» erneut antippen.
 - Die optimale Geschwindigkeit wird aktiviert.

6.3 Oberfadenspannung einstellen

Die Grundeinstellung der Oberfadenspannung erfolgt mit der Wahl des Stickmusters automatisch.

Die Oberfadenspannung wird im BERNINA Werk optimal eingestellt. Dafür werden als Ober- und Unterfaden Metrosene-/Seralonfäden der Stärke 100/2 (Firma Mettler) eingesetzt.

Werden andere Stickfäden verwendet, können Abweichungen bei der Oberfadenspannung entstehen. Dadurch wird es notwendig, die Oberfadenspannung dem Stickprojekt und dem gewünschten Stickmuster individuell anzupassen.

Je höher die Oberfadenspannung eingestellt ist, desto stärker wird der Oberfaden gespannt und der Unterfaden wird stärker in den Stoff gezogen. Bei einer geringeren Oberfadenspannung wird der Oberfaden schwächer gespannt und der Unterfaden wird dadurch schwächer in den Stoff gezogen.

Änderungen an der Oberfadenspannung wirken sich auf alle Stickmuster aus. Permanente Änderungen der Oberfadenspannung können im Setup-Programm (siehe Seite 50) vorgenommen werden.



- > «Oberfadenspannung» antippen.
- > Oberfadenspannung einstellen.

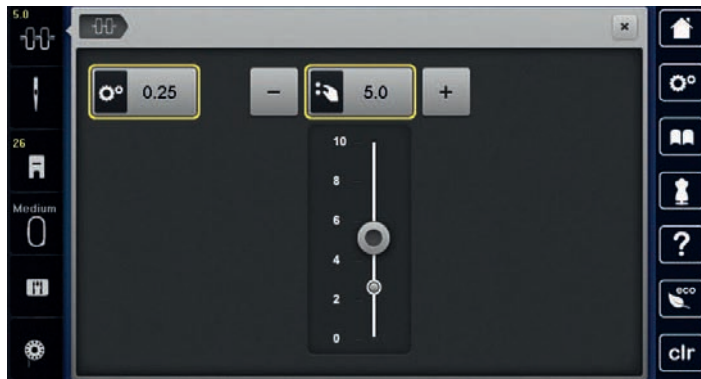

- > Um die Änderungen auf Grundeinstellung zurückzusetzen, gelb umrandetes Feld antippen.
- > Um die Änderungen im «Setup-Programm» auf Grundeinstellung zurückzusetzen, gelb umrandetes Feld links antippen.

6.4 Sticken mit Fussanlasser (Sonderzubehör)

Das Sticken mit dem Fussanlasser empfiehlt sich, um kleine Sequenzen auszusticken, z. B. beim Stumpwork.

- > Um mit dem Sticken zu beginnen, Fussanlasser drücken und gedrückt halten.



7 Pflege und Wartung

7.1 Firmware

Gesicherte Daten wiederherstellen

Wenn persönliche Daten und Einstellungen nach einer Software-Aktualisierung nicht zur Verfügung stehen, können diese nachträglich wieder auf die Maschine übertragen werden.



- > USB-Stick mit den gesicherten Daten und Einstellungen in den USB-Anschluss der Maschine einstecken.
- > «Home» antippen.



- > «Setup-Programm» antippen.



- > «Maschineneinstellungen» antippen.



- > «Wartung/Update» antippen.



- > «Firmware aktualisieren» antippen.



- > «Daten laden» antippen.
- > Warten, bis die Daten komplett übertragen sind.

ACHTUNG

BERNINA USB-Stick (Sonderzubehör) wird zu früh entfernt

Gesicherte Daten werden nicht übertragen und Maschine kann nicht verwendet werden.

- > BERNINA USB-Stick (Sonderzubehör) erst entfernen, wenn die gesicherten Daten erfolgreich übertragen wurden.

- > USB-Stick entfernen.

Firmwareversion prüfen

Die Firmware- und Hardwareversionen der Maschine und des angeschlossenen Stickmoduls werden gezeigt.



- > «Setup-Programm» antippen.



- > «Maschineneinstellungen» antippen.



- > «Informationen» antippen.



- > «Maschinendaten» antippen.





Firmware aktualisieren



Die aktuelle Firmware der Maschine und eine detaillierte Schritt-für-Schritt-Anleitung für den Aktualisierungsprozess kann auf www.bernina.com heruntergeladen werden. In der Regel werden persönliche Daten und Einstellungen bei einem Firmware-Update automatisch übernommen. Aus Sicherheitsgründen ist aber zu empfehlen, dass die Daten und Einstellungen vor einem Firmware-Update auf dem BERNINA USB-Stick gesichert werden. Wenn persönliche Daten und Einstellungen bei einem Firmware-Update verloren gehen sollten, können diese nachträglich wieder auf die Maschine übertragen werden.

Voraussetzung:

- Zubehöre wie Stickmodul oder BSR-Fuss, die an die Maschine angeschlossen werden, sind entfernt.

- > USB-Stick mit der neuen Firmwareversion in die Maschine stecken.
- > «Setup-Programm» antippen. 
- > «Maschineneinstellungen» antippen. 
- > «Wartung/Update» antippen. 
- > «Firmware aktualisieren» antippen. 
- > Um die Aktualisierung der Firmware zu starten, «Update» antippen. 
 - Hinweis:** Das Update kann mehrere Minuten dauern. Während des Updates die Maschine nicht ausschalten und den USB-Stick nicht entfernen.
 - Die Maschine startet neu. Wenn die Aktualisierung abgeschlossen ist, erscheint eine Meldung.

7.2 Maschine

Display reinigen

- > Display im ausgeschalteten Zustand mit einem weichen, leicht feuchten Microfasertuch abwischen.

Fadenrückstände unter der Stichplatte entfernen



VORSICHT

Elektrisch betriebene Komponenten

Verletzungsgefahr an Nadel und Greifer.

- > Maschine ausschalten und vom Stromnetz trennen.

Fadenrückstände unter der Stichplatte von Zeit zu Zeit entfernen.

- > Nähfuß und Nadel entfernen.
- > Stichplatte entfernen.



- > Fadenrückstände unter der Stichplatte entfernen.

Greifer reinigen



VORSICHT

Elektrisch betriebene Komponenten

Verletzungsgefahr an Nadel und Greifer.

- > Maschine ausschalten und vom Stromnetz trennen.

- > Greiferdeckel öffnen.
- > Spulenkapsel entfernen.

- > Auslösehebel nach links drücken.

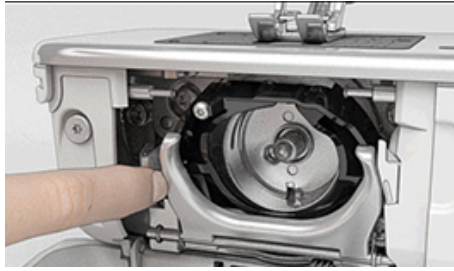

- > Verschlussbügel mit dem schwarzen Greiferbahndeckel herunterklappen.
- > Greifer entfernen.

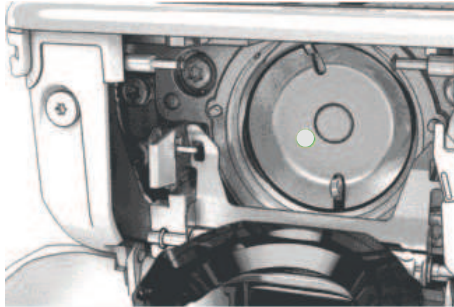

ACHTUNG

Staub und Fadenrückstände im Inneren der Maschine

Beschädigung mechanischer und elektronischer Bauteile.

- > Pinsel oder weiches Tuch verwenden.
- > Kein Druckluftspray verwenden.

- > Greiferbahn mit Pinsel und weichem Tuch reinigen. Dabei keine spitzen Gegenstände verwenden.
- > Greifer mit zwei Fingern am Stift in der Mitte halten.
- > Greifer mit der Unterkante voraus schräg von oben nach unten hinter den Greiferbahndeckel führen.
- > Greifer so positionieren, dass die beiden Nocken beim Greifertreiber in die entsprechenden Öffnungen beim Greifer passen und die farbige Markierung am Greifertreiber im Loch des Greifers sichtbar ist.
- > Greifer einsetzen.
 - Greifer ist magnetisch und wird in die richtige Position gezogen.
- > Greiferbahndeckel und Verschlussbügel schliessen, bis der Auslösebügel einrastet.
- > Zur Kontrolle am Handrad drehen.
- > Spulenkapsel einsetzen.

Greifer ölen

Durch das Ölen des Greifers kann das Auftreten von unerwünschten Geräuschen im Greiferbereich vermieden werden. BERNINA empfiehlt den Greifer zu folgenden Zeitpunkten zu ölen:

- Vor dem ersten Gebrauch der Maschine
- Nach längerem Stillstand der Maschine
- Bei intensivem Gebrauch: täglich vor dem Nähen
- Wenn die Meldung «Maschine ölen» angezeigt wird
- Bei unerwünschten Geräuschen im Greiferbereich

VORSICHT

Elektrisch betriebene Komponenten

Verletzungsgefahr an Nadel und Greifer.

- > Maschine ausschalten und vom Stromnetz trennen.

- > Spulenkapsel entfernen.

Fadenfänger reinigen



> «Setup-Programm» antippen.



> «Maschineneinstellungen» antippen.



> «Wartung/Update» antippen.



> «Fadenfänger reinigen» antippen.



> Fadenfänger gemäss den Anweisungen auf dem Display reinigen.

8 Fehler und Störungen

8.1 Fehlermeldungen

Anzeige auf dem Display	Ursache	Lösung
	Ausgewählte Nadel und Stichplatte können nicht zusammen verwendet werden.	<ul style="list-style-type: none"> > Nadel wechseln. > Stichplatte wechseln.
	Nadel befindet sich nicht an ihrem oberen Punkt.	<ul style="list-style-type: none"> > Mit dem Handrad die Nadelposition einstellen.
	Oberfaden ist aufgebraucht.	<ul style="list-style-type: none"> > Neu einfädeln.
	Oberfaden ist gerissen.	<ul style="list-style-type: none"> > Neu einfädeln.
	Unterfaden ist aufgebraucht.	<ul style="list-style-type: none"> > Neu einfädeln.
	Unterfaden ist gerissen.	<ul style="list-style-type: none"> > Greifer reinigen. > Neu einfädeln.
	Hauptmotor läuft nicht.	<ul style="list-style-type: none"> > Handrad vorsichtig im Uhrzeigersinn drehen, bis die Nadel oben steht. > Nähprojekt entfernen. Dabei nicht am Stoff oder Faden ziehen. > Stichplatte entfernen. > Fadenreste entfernen. > Greifer reinigen. > Greifer entfernen und sicherstellen, dass auf dem magnetischen Greiferrücken keine abgebrochenen Nadelspitzen haften. > Greifer korrekt einsetzen.
	Stoff unter dem Nähfuss zu dick.	<ul style="list-style-type: none"> > Stoffdicke reduzieren.

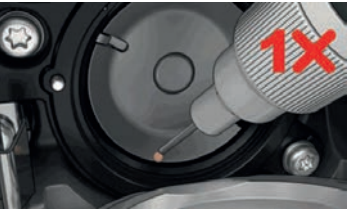
Anzeige auf dem Display	Ursache	Lösung
	Durch Vibrationen ist der Kontakt zwischen der Maschine und dem Stickmodul unterbrochen.	<ul style="list-style-type: none"> > Sicherstellen, dass das Stickmodul und die Maschine auf einer stabilen, ebenen Fläche stehen. > Stickmodul an die Maschine anschliessen.
	Nadelposition stimmt nicht mit der Mitte des Stickrahmens überein.	<ul style="list-style-type: none"> > Stickrahmen justieren.
	Stickmodul ist nicht montiert.	<ul style="list-style-type: none"> > Stickmodul an die Maschine anschliessen. > Um die Maschine prüfen zu lassen, BERNINA Fachhändler kontaktieren.
	Stickrahmen ist nicht montiert.	<ul style="list-style-type: none"> > Stickrahmen montieren.
	Stickrahmen ist montiert.	<ul style="list-style-type: none"> > Stickrahmen entfernen.
	Bewegung des Stickrahmens folgt.	<ul style="list-style-type: none"> > «Bestätigen» antippen.
	Stickmuster liegt teilweise ausserhalb des Stickrahmens.	<ul style="list-style-type: none"> > Stickmuster neu positionieren und neu aussticken.

Anzeige auf dem Display	Ursache	Lösung
	Stickmuster ist zu gross.	<ul style="list-style-type: none"> > Stickmuster verkleinern. > Grösseren Stickrahmen montieren.
Zu wenig freier Speicher auf dem BERNINA USB-Stick (Sonderzubehör).	Nicht genügend freier Speicher auf dem BERNINA USB-Stick (Sonderzubehör) vorhanden.	<ul style="list-style-type: none"> > Sicherstellen, dass der BERNINA USB-Stick (Sonderzubehör) verwendet wird. > Daten auf dem BERNINA USB-Stick (Sonderzubehör) löschen.
Keine persönlichen Daten auf dem BERNINA USB-Stick (Sonderzubehör).	Keine persönlichen Daten zur Wiederherstellung auf dem BERNINA USB-Stick (Sonderzubehör) vorhanden.	> Sicherstellen, dass die Daten und Einstellungen auf dem BERNINA USB-Stick (Sonderzubehör) gesichert wurden.
Die Wiederherstellung der persönlichen Daten ist fehlgeschlagen.	Das Firmware-Update wurde erfolgreich durchgeführt, aber die persönlichen Daten wurden nicht wiederhergestellt.	<ul style="list-style-type: none"> > Sicherstellen, dass die Daten und Einstellungen auf dem BERNINA USB-Stick gesichert wurden. > Gesicherte Daten auf die Maschine übertragen.
Kein BERNINA USB-Stick eingesteckt. Stellen Sie sicher, dass während des gesamten automatischen Updates immer der gleiche BERNINA USB-Stick eingesteckt bleibt.	BERNINA USB-Stick (Sonderzubehör) nicht eingesteckt.	> BERNINA USB-Stick (Sonderzubehör) mit genügend freiem Speicherplatz verwenden.
Das Update der Firmware ist fehlgeschlagen.	Die neue Firmware-Version wird auf dem USB-Stick nicht gefunden.	<ul style="list-style-type: none"> > Sicherstellen, dass die komprimierte ZIP-Datei für das Firmware-Update entpackt wurde. > Sicherstellen, dass die Daten für das Firmware-Update direkt auf dem Datenträger und nicht in einem Ordner auf dem USB-Stick abgelegt wurden. > Firmware aktualisieren.
 	Maschine muss gereinigt/geölt werden.	<ul style="list-style-type: none"> > Maschine reinigen. > Maschine ölen. <p>Wichtige Information zum Ölen:</p> <ul style="list-style-type: none"> > Zu viel Öl kann zu Verschmutzung von Stoff und Faden führen. > Nach dem Ölen, zuerst auf einem Probestoff sticken.

Anzeige auf dem Display	Ursache	Lösung
Der automatische Fadenschneider (beim Fadenfänger) muss gereinigt werden.	Der Fadenfänger muss gereinigt werden. Die Meldung erscheint nach Erreichen von 1000 Schneidezyklen bei jedem Einschalten der Maschine.	<ul style="list-style-type: none"> > «Bestätigen» antippen. <ul style="list-style-type: none"> – Die Maschine ruft die Funktion «Fadenfänger reinigen» auf. > Fadenfänger gemäss den Anweisungen auf dem Display reinigen. <ul style="list-style-type: none"> – Der Zähler für die Schneidezyklen wird zurückgesetzt.
Es ist Zeit für den regelmässigen Service. Kontaktieren Sie Ihren BERNINA Fachhändler für einen Termin.	<p>Die Maschine muss gewartet werden. Die Anzeige erscheint nach Erreichen des programmierten Serviceintervalls.</p> <p>Wichtige Information: Bei Einhaltung der Reinigungs- und Wartungsarbeiten wird die Funktionstüchtigkeit und lange Lebensdauer der Maschine sichergestellt. Bei Nichteinhaltung kann die Nutzungsdauer beeinträchtigt und die Garantieleistung eingeschränkt werden. Der Kostenumfang für Wartungsarbeiten ist national geregelt. Ihr BERNINA Fachhändler oder Ihre Servicestelle geben Ihnen gerne Auskunft darüber.</p>	<ul style="list-style-type: none"> > BERNINA Fachhändler kontaktieren. > Anzeige durch Antippen des Felds «ESC» vorübergehend löschen. <p>Nach dem Dritten Löschen wird die Meldung erst nach Erreichen des nächsten Serviceintervalls angezeigt.</p>
#1000	Der Nadeleinfädler ist verklemmt.	<ul style="list-style-type: none"> > Maschine ausschalten. Nadeleinfädler nach unten drücken und wieder loslassen. Maschine einschalten. > Wenn der Fehler weiterhin auftritt, BERNINA Fachhändler kontaktieren.
#1001	Die Taste «Fadenschneider» klemmt oder ist defekt.	<ul style="list-style-type: none"> > Sicherstellen, dass sich die Taste frei bewegt. > Wenn der Fehler weiterhin auftritt, BERNINA Fachhändler kontaktieren.
#1003	Die Taste «Start/Stop» klemmt oder ist defekt.	<ul style="list-style-type: none"> > Sicherstellen, dass sich die Taste frei bewegt. > Wenn der Fehler weiterhin auftritt, BERNINA Fachhändler kontaktieren.
#1004 #1005 #1010	Die genaue Fehlerursache kann nicht festgestellt werden.	<ul style="list-style-type: none"> > Maschine neu starten. > Wenn der Fehler weiterhin auftritt, BERNINA Fachhändler kontaktieren.



8.2 Störungsbehebung

Störung	Ursache	Lösung
Ungleichmässige Stichbildung	Oberfaden zu fest/zu locker.	> Oberfadenspannung einstellen. > Fadenabzug von der Garnrolle kontrollieren.
	Nadel stumpf oder krumm.	> Nadel wechseln und sicherstellen, dass eine neue BERNINA Qualitätsnadel verwendet wird.
	Schlechte Nadelqualität.	> Neue BERNINA Qualitätsnadel verwenden.
	Schlechte Fadenqualität.	> Qualitätsfaden verwenden.
	Falsches Nadel-Faden-Verhältnis.	> Nadel der Fadenstärke anpassen.
	Falsch eingefädelt.	> Neu einfädeln.
Ungleichmässige Stichbildung	Falsche Spulenkapsel verwendet.	> Mitgelieferte Spulenkapsel verwenden.
Fehlstiche	Falsche Nadel.	> Nadeln des Nadelsystems 130/705H verwenden.
	Nadel stumpf oder krumm.	> Nadel wechseln.
	Schlechte Nadelqualität.	> Neue BERNINA Qualitätsnadel verwenden.
	Nadel falsch eingesetzt.	> Nadel mit der flachen Seite nach hinten bis zum Anschlag in den Nadelhalter einführen und festschrauben.
	Falsche Nadelspitze.	> Nadelspitze der textilen Struktur des Stickprojekts anpassen.
Nahtfehler	Fadenreste zwischen den Fadenspannscheiben.	> Gefalteten, dünnen Stoff (keine Aussenkanten verwenden) mehrmals durch die Fadenspannscheiben ziehen.
	Falsch eingefädelt.	> Neu einfädeln.
	Fadenreste unter der Spulenkapselfeder.	> Fadenreste unter der Feder entfernen.

Störung	Ursache	Lösung
Maschine startet nicht	Unvorteilhafte Raumtemperatur.	<ul style="list-style-type: none"> > Maschine 1 Stunde vor Nähbeginn in einen Raum mit Zimmertemperatur stellen. > Maschine anschliessen und einschalten.
	Maschine defekt.	<ul style="list-style-type: none"> > BERNINA Fachhändler kontaktieren.
Licht der Taste «Start-/Stopp» leuchtet nicht	Licht defekt.	<ul style="list-style-type: none"> > BERNINA Fachhändler kontaktieren.
Nählicht und Freiarmlicht leuchten nicht	Nählicht ausgeschaltet.	<ul style="list-style-type: none"> > «Nählicht ein-/ausschalten» antippen.
	Einstellungen im Setup-Programm.	<ul style="list-style-type: none"> > Im Setup-Programm einschalten.
	Nählicht defekt.	<ul style="list-style-type: none"> > BERNINA Fachhändler kontaktieren.
Oberfadenüberwachung reagiert nicht	Einstellungen im Setup-Programm.	<ul style="list-style-type: none"> > Im Setup-Programm einschalten.
	Oberfadenwächter defekt.	<ul style="list-style-type: none"> > BERNINA Fachhändler kontaktieren.
Unterfadenüberwachung reagiert nicht	Einstellungen im Setup-Programm.	<ul style="list-style-type: none"> > Im Setup-Programm einschalten.
	Unterfadenwächter defekt.	<ul style="list-style-type: none"> > BERNINA Fachhändler kontaktieren.
Fehler beim Firmware-Update	USB-Stick wird nicht erkannt.	<ul style="list-style-type: none"> > BERNINA USB-Stick verwenden.
	Update-Prozess ist blockiert und Sanduhr auf dem Display bleibt stehen.	<ul style="list-style-type: none"> > USB-Stick entfernen. > Maschine ausschalten. > Maschine einschalten. > Anweisungen auf dem Display befolgen.
	Dateien des Firmware-Updates werden nicht gefunden.	<ul style="list-style-type: none"> > Komprimierte ZIP-Datei entpacken. > Daten für das Firmware-Update direkt auf dem Datenträger und nicht in einem Ordner auf dem USB-Stick ablegen.

9 Lagerung und Entsorgung

9.1 Maschine lagern

Es ist zu empfehlen, die Maschine in der Originalverpackung aufzubewahren. Wird die Maschine in einem kalten Raum aufbewahrt, diese ca. 1 Stunde vor Gebrauch in einen Raum mit Zimmertemperatur stellen.

- > Maschine ausschalten und vom Stromnetz trennen.
- > Maschine nicht im Freien lagern.
- > Maschine gegen Witterungseinflüsse schützen.

9.2 Maschine entsorgen

- > Maschine reinigen.
- > Bestandteile nach Werkstoffen sortieren und gemäss der örtlich geltenden Gesetze und Vorschriften entsorgen.



10 Technische Daten

Bezeichnung	Wert	Einheit
Maximale Stoffdicke	12,5 (0,49)	mm (in)
Nählicht	30	LED
Maximale Geschwindigkeit	1000	Stiche pro Minute
Masse ohne Garnrollenhalter (B × H × T)	522 × 358 × 214 (20,55 × 14,09 × 8,43)	mm (in)
Gewicht	13,5 (29,76)	kg (lb)
Energieverbrauch	140	W
Eingangsspannung	100 – 240	V
Schutzklasse (Elektrotechnik)	II	









11 Übersicht Muster

11.1 Übersicht Stickmuster

Stickmuster bearbeiten





































Lassen Sie Ihrer Kreativität freien Lauf. Es stehen Ihnen eine vielfältige Auswahl an Stickmustern zu Verfügung.

Steht unter der Stickmuster­nummer eines der folgenden Piktogramme, finden Sie unter <https://www.bernina.com/specialeffects> weitere Informationen.

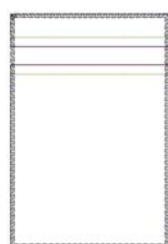
	Freistehende Spitze		PunchWork
	Lochstickerei		Kordelstickerei
	Fransenstickerei		Projekte im Rahmen
	Applikation		Puffy Schriften
	CutWork		Quilten
	PaintWork		Trapunto
	CrystalWork		

Projekte

Die ausführlichen Stick­anleitungen finden Sie unter www.bernina.com/7seriesdesigns.

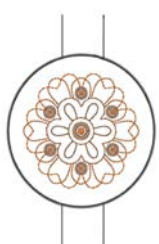













































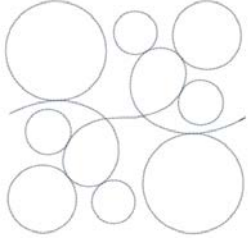

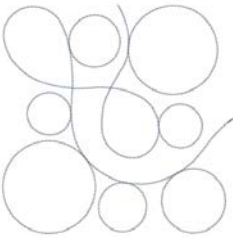







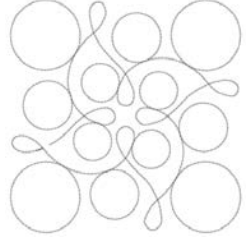

 BE700701	 209 x 202 mm 8.2 x 7.9 inch	 10.796	 12604-02	 45 x 153 mm 1.8 x 6 inch	 10.924
1.  Isacord 40 0660 2.  Isacord 40 5500 3.  Isacord 40 3102			1.  Isacord 40 4610 2.  Isacord 40 4610 3.  Isacord 40 4531 4.  Isacord 40 4610 5.  Isacord 40 4740 6.  Isacord 40 0015 7.  Isacord 40 0800 8.  Isacord 40 1310 9.  Isacord 40 4610 10.  Isacord 40 4610		
 12519-03	 108 x 161 mm 4.3 x 6.4 inch	 1.864	 19999-032	 90 x 143 mm 3.6 x 5.6 inch	 4.002
1.  Isacord 40 5832 2.  Isacord 40 1902 3.  Isacord 40 3355 4.  Isacord 40 0020			1.  Isacord 40 0020 2.  Isacord 40 0020 3.  Isacord 40 9302 4.  Isacord 40 1154 5.  Isacord 40 9302 6.  Isacord 40 0020		

Quiltmuster

 Bd289	 202 x 201 mm 7.9 x 7.9 inch	 6.190	 Bd285	 202 x 201 mm 7.9 x 7.9 inch	 6.531
<p>1.  Isacord 40 4625</p> 			<p>1.  Isacord 40 1305</p> 		
 Bd288	 202 x 201 mm 7.9 x 7.9 inch	 5.806	 Bd292	 95 x 95 mm 3.7 x 3.7 inch	 3.036
<p>1.  Isacord 40 0703</p> 			<p>1.  Isacord 40 3332</p> 		
 Bd299	 94 x 95 mm 3.7 x 3.7 inch	 3.133	 Bd308	 95 x 94 mm 3.7 x 3.7 inch	 3.763
<p>1.  Isacord 40 0700</p> 			<p>1.  Isacord 40 1311</p> 		
 Bd413_48	 97 x 97 mm 3.8 x 3.8 inch	 4.124	 Bd837_48	 123 x 123 mm 4.9 x 4.9 inch	 1.629
<p>1.  Isacord 40 5822</p> 			<p>1.  Isacord 40 0138</p> 		
 12380-43	 123 x 123 mm 4.9 x 4.9 inch	 8.248	 12380-30	 89 x 96 mm 3.5 x 3.8 inch	 4.442
<p>1.  Isacord 40 1543</p> 			<p>1.  Isacord 40 1543</p> 		



Übersicht Muster

<p> 12380-04</p>	<p> 83 x 90 mm 3.3 x 3.5 inch</p>	<p> 2.189</p>	<p> 12380-08</p>	<p> 89 x 89 mm 3.5 x 3.5 inch</p>	<p> 2.725</p>		
<p>1.  Isacord 40 1543</p>				<p>1.  Isacord 40 1543</p>			
<p> 12380-09</p>	<p> 112 x 62 mm 4.4 x 2.4 inch</p>	<p> 1.945</p>	<p> 12380-22</p>	<p> 110 x 61 mm 4.4 x 2.4 inch</p>	<p> 2.487</p>		
<p>1.  Isacord 40 1543</p>				<p>1.  Isacord 40 1543</p>			
<p> 12380-10</p>	<p> 152 x 357 mm 6 x 14 inch</p>	<p> 24.674</p>	<p> Bd796_48</p>	<p> 47 x 173 mm 1.9 x 6.8 inch</p>	<p> 521</p>		
<p>1.  Isacord 40 1543</p>				<p>1.  Isacord 40 3654</p>			
<p> Bd800_48</p>	<p> 126 x 122 mm 5 x 4.8 inch</p>	<p> 609</p>	<p> Bd801_48</p>	<p> 122 x 122 mm 4.8 x 4.8 inch</p>	<p> 594</p>		
<p>1.  Isacord 40 3654</p>				<p>1.  Isacord 40 3654</p>			
<p> Bd804_48</p>	<p> 123 x 124 mm 4.8 x 4.9 inch</p>	<p> 904</p>	<p> Bd394_48</p>	<p> 97 x 97 mm 3.8 x 3.8 inch</p>	<p> 4.586</p>		
<p>1.  Isacord 40 0111</p>				<p>1.  Isacord 40 3641</p>			
<p> Bd412_48</p>	<p> 89 x 53 mm 3.5 x 2.1 inch</p>	<p> 1.427</p>	<p> Bd513_48</p>	<p> 64 x 63 mm 2.5 x 2.5 inch</p>	<p> 950</p>		
<p>1.  Isacord 40 1335</p>				<p>1.  Isacord 40 1532</p>			

Bd514_48 64 x 63 mm 2.5 x 2.5 inch 926

1. Isacord 40 1352



Bd553_48 114 x 121 mm 4.5 x 4.8 inch 5.845

1. Isacord 40 2153

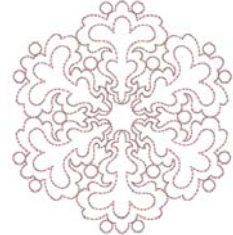

Bd567_48 108 x 108 mm 4.3 x 4.3 inch 4.359

1. Isacord 40 2530



Bd554_48 110 x 110 mm 4.3 x 4.3 inch 6.252

1. Isacord 40 2153

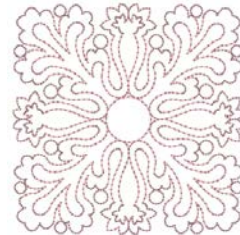

Bd659_48 66 x 219 mm 2.6 x 8.6 inch 2.378

1. Isacord 40 2910



Bd665_48 160 x 118 mm 6.3 x 4.6 inch 2.834

1. Isacord 40 2910

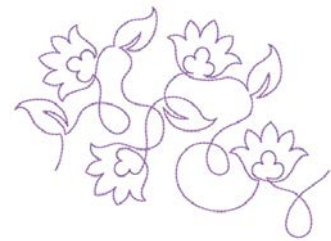

He959_48 121 x 121 mm 4.8 x 4.8 inch 2.473

1. Isacord 40 1902



Bordüren und Spitze

82011-30 107 x 130 mm 4.2 x 5.1 inch 17.281

1. Isacord 40 0660
2. Yenmet 7013











































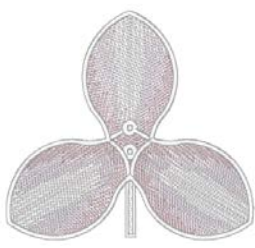











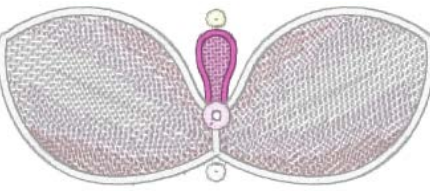













































































82011-28 134 x 99 mm 5.3 x 3.9 inch 23.505

1. Isacord 40 0660
2. Yenmet 7013



Übersicht Muster

Nb952_48	 108 x 119 mm 4.3 x 4.7 inch	 22.514	 Oc00303	 101 x 110 mm 4 x 4.4 inch	 35.018
<ol style="list-style-type: none"> 1.  Isacord 40 0020 2.  Isacord 40 4174 3.  Isacord 40 0020 4.  Isacord 40 4174 5.  Isacord 40 0761 		<ol style="list-style-type: none"> 1. Isacord 40 0015 			
 12410-08	 80 x 168 mm 3.2 x 6.6 inch	 22.500	 12410-07	 115 x 158 mm 4.5 x 6.2 inch	 30.450
<ol style="list-style-type: none"> 1.  Isacord 40 1874 		<ol style="list-style-type: none"> 1.  Isacord 40 1874 			
 12410-15	 29 x 133 mm 1.1 x 5.3 inch	 9.439	 12454-05	 117 x 108 mm 4.6 x 4.3 inch	 17.499
<ol style="list-style-type: none"> 1.  Isacord 40 4752 		<ol style="list-style-type: none"> 1. Isacord 40 0015 2.  Isacord 40 2650 3.  Isacord 40 2155 4. Isacord 40 0015 			
 12454-06	 117 x 48 mm 4.6 x 1.9 inch	 11.296	 12454-07	 48 x 57 mm 1.9 x 2.3 inch	 6.491
<ol style="list-style-type: none"> 1.  Isacord 40 0250 2.  Isacord 40 2508 3. Isacord 40 0015 4.  Isacord 40 2650 5.  Isacord 40 2155 6. Isacord 40 0015 7.  Isacord 40 2650 		<ol style="list-style-type: none"> 1. Isacord 40 0015 2.  Isacord 40 2650 3.  Isacord 40 2508 4.  Isacord 40 2155 5.  Isacord 40 2650 			
Fa981	 35 x 142 mm 1.4 x 5.6 inch	 3.709	Be790701	 114 x 230 mm 4.5 x 9.1 inch	 15.223
<ol style="list-style-type: none"> 1.  Isacord 40 1055 		<ol style="list-style-type: none"> 1.  Isacord 40 2300 			
Be790704	 72 x 218 mm 2.9 x 8.6 inch	 3.638	Be790703	 71 x 186 mm 2.8 x 7.3 inch	 11.125
<ol style="list-style-type: none"> 1.  Isacord 40 0501 2.  Isacord 40 5633 3.  Isacord 40 0020 		<ol style="list-style-type: none"> 1.  Isacord 40 1306 			

<p>Be790702  73 x 190 mm 2.9 x 7.5 inch  9.135</p>	<p>21013-29  40 x 152 mm 1.6 x 6 inch  7.569</p>
<p>1.  Isacord 40 0442</p> 	<p>1.  Isacord 40 4332</p> 
<p>21013-30  76 x 76 mm 3 x 3 inch  5.519</p>	<p> 12398-29  26 x 153 mm 1 x 6 inch  13.035</p>
<p>1.  Isacord 40 4332</p> 	<p>1.  Isacord 40 1351</p> 
<p> 12398-30  77 x 77 mm 3 x 3 inch  12.150</p>	<p> Oc33411  24 x 177 mm 0.9 x 7 inch  15.868</p>
<p>1.  Isacord 40 1351</p> 	<p>1. Isacord 40 0015</p> 
<p>Cm471_48  59 x 190 mm 2.3 x 7.5 inch  13.902</p>	<p>Fb403_48  52 x 208 mm 2.1 x 8.2 inch  3.077</p>
<p>1.  Isacord 40 0630 2.  Isacord 40 0932 3.  Isacord 40 3953 4.  Isacord 40 3730 5.  Isacord 40 3652 6.  Isacord 40 4174 7.  Isacord 40 0101</p> 	<p>1.  Isacord 40 1355 2.  Isacord 40 3953</p> 
<p>Fq785_48  92 x 342 mm 3.6 x 13.5 inch  11.130</p>	<p>Fq969_48  52 x 162 mm 2 x 6.4 inch  2.804</p>
<p>1.  Yenmet 7003 2.  Yenmet 7008 3.  Yenmet 7001</p> 	<p>1.  Isacord 40 0170 2.  Isacord 40 0873 3.  Isacord 40 1860</p> 
<p>Fq736_48  8 x 253 mm 0.3 x 10 inch  5.097</p>	<p>Bd582_48  48 x 171 mm 1.9 x 6.7 inch  4.177</p>
<p>1.  Isacord 40 1375 2.  Isacord 40 4111 3.  Isacord 40 3962</p> 	<p>1.  Isacord 40 0870</p> 

Übersicht Muster

Na912_48	115 x 16 mm 4.5 x 0.6 inch	2.285	Na914_48	19 x 120 mm 0.7 x 4.7 inch	4.691
-----------------	-------------------------------	-------	-----------------	-------------------------------	-------

1. Isacord 40 4230
2. Isacord 40 0853



1. Isacord 40 3151
2. Isacord 40 3251
3. Isacord 40 3150



Nb478_48	122 x 85 mm 4.8 x 3.4 inch	16.092	Fq945_48	94 x 95 mm 3.7 x 3.7 inch	8.798
-----------------	-------------------------------	--------	-----------------	------------------------------	-------

1. Isacord 40 0870
2. Isacord 40 0670
3. Isacord 40 0870
4. Isacord 40 0670



1. Isacord 40 0672
2. Isacord 40 0873



Fb422_48	52 x 34 mm 2.1 x 1.3 inch	4.665	Fb423_48	133 x 54 mm 5.2 x 2.1 inch	15.013
-----------------	------------------------------	-------	-----------------	-------------------------------	--------

1. Isacord 40 3151



1. Isacord 40 3150



Kinder

Be790305	118 x 145 mm 4.6 x 5.7 inch	13.118	12535-03	160 x 120 mm 6.3 x 4.7 inch	7.380
-----------------	--------------------------------	--------	-----------------	--------------------------------	-------

1. Isacord 40 0015
2. Applique 1
3. Applique 3
4. Isacord 40 3541
5. Applique 1
6. Applique 3
7. Isacord 40 0345
8. Applique 1
9. Applique 3
10. Isacord 40 1900
11. Isacord 40 0020
12. Isacord 40 0015



1. Isacord 40 4610
2. Isacord 40 4610
3. Isacord 40 1430
4. Isacord 40 1430
5. Isacord 40 0131
6. Isacord 40 0131
7. Isacord 40 4610
8. Isacord 40 2520
9. Isacord 40 2520



Be790302	68 x 66 mm 2.7 x 2.6 inch	6.242	Be790303	70 x 70 mm 2.7 x 2.8 inch	5.764
-----------------	------------------------------	-------	-----------------	------------------------------	-------

1. Isacord 40 1114
2. Isacord 40 1730
3. Isacord 40 2101
4. Isacord 40 1114
5. Isacord 40 0020
6. Isacord 40 0015
7. Isacord 40 4116
8. Isacord 40 1600



1. Isacord 40 0532
2. Isacord 40 1300
3. Isacord 40 0020
4. Isacord 40 0015



Be790304 127 x 66 mm
5 x 2.6 inch 6.593

1. Isacord 40 4033
2. Isacord 40 1061
3. Isacord 40 1900
4. Isacord 40 1114
5. Isacord 40 4952
6. Isacord 40 1753
7. Isacord 40 2912
8. Isacord 40 5730

Be790307 142 x 127 mm
5.6 x 5 inch 19.667

1. Applique 1
2. Applique 3
3. Isacord 40 3130
4. Applique 1
5. Applique 3
6. Isacord 40 0003
7. Isacord 40 1720
8. Isacord 40 0020
9. Isacord 40 0520
10. Isacord 40 3541

Be790308 155 x 178 mm
6.1 x 7 inch 25.448

1. Isacord 40 0020
2. Applique 1
3. Applique 2
4. Isacord 40 1720

12421-03 46 x 48 mm
1.8 x 1.9 inch 2.328

1. Isacord 40 0020
2. Isacord 40 0015
3. Isacord 40 0111

Nb193_48 113 x 96 mm
4.5 x 3.8 inch 8.079

1. Isacord 40 2363
2. Isacord 40 2650
3. Isacord 40 5912
4. Isacord 40 1600
5. Isacord 40 3920
6. Isacord 40 0821
7. Isacord 40 2830
8. Isacord 40 2153

Cm384 77 x 80 mm
3 x 3.2 inch 9.534

1. Isacord 40 3732
2. Isacord 40 3444
3. Isacord 40 3761
4. Isacord 40 3641
5. Isacord 40 5411
6. Isacord 40 3611
7. Isacord 40 0020

Cm226_48 63 x 63 mm
2.5 x 2.5 inch 6.214

1. Isacord 40 0101
2. Isacord 40 0131
3. Isacord 40 0152
4. Isacord 40 0020
5. Isacord 40 1755

Cm193 107 x 127 mm
4.2 x 5 inch 12.461

1. Isacord 40 2155
2. Isacord 40 2250
3. Isacord 40 2155
4. Isacord 40 2250
5. Isacord 40 2153
6. Isacord 40 3151
7. Isacord 40 2155
8. Isacord 40 0142
9. Isacord 40 2155
10. Isacord 40 2171





























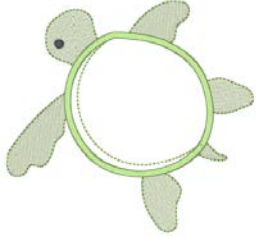

Cm220_48 71 x 72 mm
2.8 x 2.8 inch 7.571

1. Isacord 40 1755
2. Isacord 40 0101
3. Isacord 40 0142
4. Isacord 40 0101
5. Isacord 40 4071
6. Isacord 40 0142
7. Isacord 40 0934
8. Isacord 40 0020









Wp325 78 x 94 mm
3.1 x 3.7 inch 14.796

1. Isacord 40 0101
2. Isacord 40 1860
3. Isacord 40 0552
4. Isacord 40 0124
5. Isacord 40 0851
6. Isacord 40 0761
7. Isacord 40 0832
8. Isacord 40 0853
9. Isacord 40 0934
10. Isacord 40 0945
11. Isacord 40 1876
12. Isacord 40 0131
13. Isacord 40 0111
14. Isacord 40 0020

Übersicht Muster



<p>Cm428_48  78 x 106 mm 3.1 x 4.2 inch  15.875</p> <ol style="list-style-type: none"> 1. Isacord 40 0832 2. Isacord 40 0660 3. Isacord 40 0651 4. Isacord 40 0853 5. Isacord 40 0933 6. Isacord 40 3045 7. Isacord 40 2764 8. Isacord 40 2832 9. Isacord 40 0020 10. Isacord 40 0651 11. Isacord 40 0015 	<p>Cm404_48  47 x 165 mm 1.9 x 6.5 inch  7.630</p> <ol style="list-style-type: none"> 1. Isacord 40 3710 2. Isacord 40 3730 3. Isacord 40 2250 4. Isacord 40 2320 
<p>Cm368  70 x 140 mm 2.8 x 5.5 inch  4.392</p> <ol style="list-style-type: none"> 1. Isacord 40 2550 2. Isacord 40 3971 3. Isacord 40 3130 4. Isacord 40 0713 5. Isacord 40 0131 	<p>Cm147  55 x 100 mm 2.2 x 3.9 inch  6.170</p> <ol style="list-style-type: none"> 1. Isacord 40 1755 2. Isacord 40 0713 3. Isacord 40 0704 4. Isacord 40 6141 5. Isacord 40 3251 6. Isacord 40 1600 
<p>Cm022  89 x 97 mm 3.5 x 3.8 inch  10.323</p> <ol style="list-style-type: none"> 1. Isacord 40 0532 2. Isacord 40 5730 3. Isacord 40 1730 4. Isacord 40 0015 5. Isacord 40 1352 6. Isacord 40 2920 7. Isacord 40 5531 8. Isacord 40 3040 	<p>Cm442  46 x 47 mm 1.8 x 1.8 inch  4.720</p> <ol style="list-style-type: none"> 1. Isacord 40 0622 2. Isacord 40 1703 3. Isacord 40 1913 4. Isacord 40 3722 5. Isacord 40 3600 6. Isacord 40 0182 7. Isacord 40 0176 8. Isacord 40 0015 
<p>Cm362_48  120 x 113 mm 4.7 x 4.4 inch  6.792</p> <ol style="list-style-type: none"> 1. Isacord 40 6051 2. Isacord 40 5650 3. Isacord 40 6051 4. Isacord 40 5531 5. Isacord 40 4174 6. Isacord 40 5610 	<p>Wp201_48  76 x 92 mm 3 x 3.6 inch  12.651</p> <ol style="list-style-type: none"> 1. Isacord 40 2166 2. Isacord 40 6141 3. Isacord 40 0101 4. Isacord 40 0651 5. Isacord 40 0142 6. Isacord 40 0131 7. Isacord 40 4174 8. Isacord 40 3761 9. Isacord 40 3641 10. Isacord 40 3710 11. Isacord 40 0832 
<p>Cm286_48  98 x 82 mm 3.9 x 3.2 inch  10.564</p> <ol style="list-style-type: none"> 1. Isacord 40 0015 2. Isacord 40 3650 3. Isacord 40 0142 4. Isacord 40 2363 5. Isacord 40 0020 6. Isacord 40 5531 7. Isacord 40 2550 	<p>Ck970  85 x 82 mm 3.3 x 3.2 inch  16.571</p> <ol style="list-style-type: none"> 1. Isacord 40 0151 2. Isacord 40 0152 3. Isacord 40 0124 4. Isacord 40 0131 5. Isacord 40 3150 6. Isacord 40 2830 7. Isacord 40 3040 8. Isacord 40 3640 9. Isacord 40 3710 10. Isacord 40 2051 11. Isacord 40 1725 12. Isacord 40 3743 13. Isacord 40 0015 14. Isacord 40 3743 





Rc765  100 x 99 mm
3.9 x 3.9 inch  11.289

1.  Isacord 40 0853
2.  Isacord 40 1913
3.  Isacord 40 0015
4.  Isacord 40 3750
5.  Isacord 40 0131
6.  Isacord 40 1565
7.  Isacord 40 0824
8.  Isacord 40 1800
9.  Isacord 40 4230

















Blumen

80001-23  85 x 102 mm
3.4 x 4 inch  4.257



1.  Isacord 40 1102
2.  Isacord 40 1805
3.  Isacord 40 6011
4.  Isacord 40 4174











82006-02  128 x 205 mm
5.1 x 8.1 inch  34.459

1.  Isacord 40 4174
2.  Isacord 40 0108
3.  Isacord 40 0771
4.  Isacord 40 4421
5.  Isacord 40 0643
6.  Isacord 40 0660
7.  Isacord 40 0660
8.  Isacord 40 0660
9.  Isacord 40 0832
10.  Isacord 40 0643
11.  Isacord 40 4421
12.  Isacord 40 1526
13.  Isacord 40 4421
14.  Isacord 40 0660
15.  Isacord 40 4174











Be790404  202 x 226 mm
7.9 x 8.9 inch  41.537

1.  Isacord 40 5912
2.  Isacord 40 6031
3.  Isacord 40 2155
4.  Isacord 40 2500
5.  Isacord 40 3241
6.  Isacord 40 3211
7.  Isacord 40 6031
8.  Isacord 40 5912







12392-01  112 x 157 mm
4.4 x 6.2 inch  7.321

1.  Isacord 40 1030
2.  Applique 1
3.  Applique 3
4.  Isacord 40 1102
5.  Isacord 40 4240
6.  Isacord 40 4220
7.  Applique 1
8.  Applique 3
9.  Applique 1











12392-13  112 x 203 mm
4.4 x 8 inch  5.418

1.  Isacord 40 4240
2.  Isacord 40 4220
3.  Isacord 40 1030
4.  Isacord 40 1102











12457-13  113 x 130 mm
4.4 x 5.1 inch  6.676



1.  Isacord 40 6051
2.  Isacord 40 5730
3.  Isacord 40 5722
4.  Isacord 40 2905
5.  Isacord 40 0311
6.  Isacord 40 5115
7.  Isacord 40 5220
8.  Isacord 40 5100



12457-06  106 x 172 mm
4.2 x 6.8 inch  12.636

































































































1.  Isacord 40 3150
2.  Isacord 40 3210
3.  Isacord 40 0311
4.  Isacord 40 3331
5.  Isacord 40 3711
6.  Isacord 40 2250
7.  Isacord 40 2241
8.  Isacord 40 2051



Be790401  206 x 242 mm
8.1 x 9.5 inch  11.593

1.  Isacord 40 1900



Be790405  126 x 185 mm 4.9 x 7.3 inch  7.734	Fs142_48  69 x 144 mm 2.7 x 5.7 inch  8.554
1.  Isacord 40 3102 	1.  Isacord 40 3711 2.  Isacord 40 0020 
82004-34  199 x 281 mm 7.8 x 11.1 inch  37.787 1.  Isacord 40 5722 2.  Applique 1 3.  Isacord 40 5050 4.  Isacord 40 0015 5.  Applique 1 6.  Isacord 40 1220 7.  Applique 1 8.  Isacord 40 1900 9.  Isacord 40 0506 10.  Applique 1 11.  Isacord 40 0640 12.  Isacord 40 1730 13.  Isacord 40 0015 14.  Applique 1 15.  Isacord 40 5050 16.  Isacord 40 4111 17.  Isacord 40 0015 18.  Isacord 40 4111 19.  Isacord 40 5610 	Be790409  188 x 215 mm 7.4 x 8.5 inch  37.708 1.  Isacord 40 0142 2.  Isacord 40 0822 3.  Isacord 40 0345 4.  Isacord 40 4122 5.  Isacord 40 3554 6.  Isacord 40 1300 
Be790402  146 x 280 mm 5.8 x 11 inch  11.199 1.  Isacord 40 0933 	Fq061  75 x 93 mm 3 x 3.6 inch  12.122 1.  Isacord 40 1344 2.  Isacord 40 0250 3.  Isacord 40 0352 4.  Isacord 40 5833 5.  Isacord 40 3640 6.  Isacord 40 3641 7.  Isacord 40 1344 8.  Isacord 40 5643 
Fq801  46 x 112 mm 1.8 x 4.4 inch  8.687 1.  Isacord 40 5633 2.  Isacord 40 5730 3.  Isacord 40 1154 4.  Isacord 40 2011 5.  Isacord 40 1921 6.  Isacord 40 1753 7.  Isacord 40 2530 8.  Isacord 40 2560 9.  Isacord 40 2363 	Fq273  88 x 193 mm 3.5 x 7.6 inch  5.100 1.  Isacord 40 0465 2.  Isacord 40 0853 3.  Isacord 40 2550 4.  Isacord 40 0933 
Fq055  84 x 100 mm 3.3 x 3.9 inch  16.145 1.  Isacord 40 0546 2.  Isacord 40 0232 3.  Isacord 40 0520 4.  Isacord 40 0250 5.  Isacord 40 5833 6.  Isacord 40 6141 7.  Isacord 40 0941 8.  Isacord 40 5933 	Fq982_48  150 x 218 mm 5.9 x 8.6 inch  30.949 1.  Isacord 40 1860 2.  Isacord 40 0771 3.  Isacord 40 0873 4.  Isacord 40 0170 5.  Isacord 40 0870 6.  Isacord 40 2051 7.  Isacord 40 0862 8.  Isacord 40 2152 

Fb268 124 x 87 mm
4.9 x 3.4 inch 7.569

1. Isacord 40 3211
2. Isacord 40 1755
3. Isacord 40 3241
4. Isacord 40 0700
5. Isacord 40 0904
6. Isacord 40 2160
7. Isacord 40 1725
8. Isacord 40 0504
9. Isacord 40 5933
10. Isacord 40 5610
11. Isacord 40 5933
12. Isacord 40 1725

Fq934_48 119 x 192 mm
4.7 x 7.6 inch 26.468

1. Isacord 40 0873
2. Isacord 40 0776
3. Isacord 40 0020
4. Isacord 40 5650
5. Isacord 40 5531
6. Isacord 40 5513
7. Isacord 40 3130
8. Isacord 40 2920
9. Isacord 40 3350
10. Isacord 40 3210
11. Isacord 40 0015
12. Isacord 40 0230
13. Isacord 40 3541
14. Isacord 40 0873
15. Isacord 40 0776

Cm418 46 x 87 mm
1.8 x 3.4 inch 3.578

1. Isacord 40 5822
2. Isacord 40 5833
3. Isacord 40 2155
4. Isacord 40 3045
5. Isacord 40 3130
6. Isacord 40 3211
7. Isacord 40 0520
8. Isacord 40 0703

Fq972_48 111 x 73 mm
4.4 x 2.9 inch 8.487

1. Isacord 40 0873
2. Isacord 40 1860
3. Isacord 40 0170

Fq548_48 94 x 159 mm
3.7 x 6.3 inch 4.879

1. Isacord 40 2241
2. Isacord 40 1860
3. Isacord 40 2152
4. Isacord 40 0552
5. Isacord 40 6051
6. Isacord 40 5833
7. Isacord 40 5934
8. Isacord 40 0970

Nb513 104 x 112 mm
4.1 x 4.4 inch 5.912

1. Isacord 40 0131
2. Isacord 40 4174

Fq274 63 x 78 mm
2.5 x 3.1 inch 2.848

1. Isacord 40 0232
2. Isacord 40 0465
3. Isacord 40 2550
4. Isacord 40 0853
5. Isacord 40 0933

Nb668 114 x 165 mm
4.5 x 6.5 inch 4.600

1. Isacord 40 0020
2. Isacord 40 0824
3. Isacord 40 0542



Fq331 85 x 64 mm
3.3 x 2.5 inch 5.007

1. Isacord 40 1172
2. Isacord 40 6141
3. Isacord 40 5552
4. Isacord 40 3962
5. Isacord 40 4113



Fq738_48 51 x 101 mm
2 x 4 inch 3.777

1. Isacord 40 3962
2. Isacord 40 0670
3. Isacord 40 5822
4. Isacord 40 1375



Fq434	 100 x 162 mm 3.9 x 6.4 inch	 17.087	Fb419_48	 64 x 56 mm 2.5 x 2.2 inch	 1.829
--------------	--	--	-----------------	--	---



1.  Isacord 40 5050
2.  Isacord 40 5833
3.  Isacord 40 5610



1.  Isacord 40 6141
2.  Isacord 40 3151







Ws673	 68 x 170 mm 2.7 x 6.7 inch	 4.465
--------------	---	---

1.  Isacord 40 0842
2.  Isacord 40 1565





Jahreszeiten

12384-02	 133 x 203 mm 5.2 x 8 inch	 25.217	12384-11	 84 x 190 mm 3.3 x 7.5 inch	 12.632
-----------------	---	---	-----------------	--	---







1.  Isacord 40 0945
2.  Isacord 40 4220
3.  Isacord 40 4531
4.  Isacord 40 4752
5.  Isacord 40 0352
6.  Isacord 40 0454





1.  Isacord 40 6151
2.  Isacord 40 0352



12443-03	 120 x 161 mm 4.7 x 6.4 inch	 18.124	12443-11	 73 x 193 mm 2.9 x 7.6 inch	 11.300
-----------------	--	--	-----------------	---	--





1.  Isacord 40 0111
2.  Isacord 40 0182
3.  Isacord 40 3630
4.  Isacord 40 3722
5.  Isacord 40 0182
6.  Isacord 40 3630
7.  Isacord 40 3722





1.  Isacord 40 0176
2.  Isacord 40 3820















12427-01	 134 x 167 mm 5.3 x 6.6 inch	 25.591	12427-11	 82 x 126 mm 3.2 x 5 inch	 8.886
-----------------	--	--	-----------------	---	---

1.  Isacord 40 1055
2.  Isacord 40 1010
3.  Isacord 40 1335
4.  Isacord 40 1514
5.  Isacord 40 1362





1.  Isacord 40 0660
2.  Isacord 40 0532







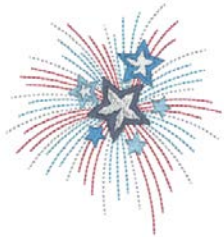

<p>12400-03</p>	<p>↗ 123 x 161 mm 4.9 x 6.3 inch</p>	<p>☞ 19.286</p>	<p>12400-11</p>	<p>↗ 74 x 212 mm 2.9 x 8.3 inch</p>	<p>☞ 12.372</p>
<p>1. Isacord 40 0853 2. Isacord 40 0250 3. Isacord 40 0352 4. Isacord 40 5833</p>			<p>1. Isacord 40 0250 2. Isacord 40 4430</p>		
<p>Hg319_48</p>			<p>↗ 89 x 151 mm 3.5 x 6 inch</p>		
<p>1. Isacord 40 5822</p>			<p>1. Isacord 40 2101</p>		
<p>Bd603_48</p>			<p>↗ 80 x 78 mm 3.2 x 3.1 inch</p>		
<p>1. Isacord 40 3600</p>			<p>1. Isacord 40 3650 2. Isacord 40 3840 3. Isacord 40 3641</p>		
<p>Hg053_48</p>			<p>↗ 122 x 122 mm 4.8 x 4.8 inch</p>		
<p>1. Isacord 40 5531 2. Isacord 40 5643 3. Isacord 40 1805</p>			<p>1. Isacord 40 0020 2. Isacord 40 0600 3. Isacord 40 0800 4. Isacord 40 0020</p>		
<p>Nb769_48</p>			<p>↗ 128 x 125 mm 5.1 x 4.9 inch</p>		
<p>1. Isacord 40 0651</p>			<p>1. Isacord 40 1703 2. Isacord 40 1906 3. Isacord 40 2113 4. Isacord 40 1430 5. Isacord 40 2363 6. Isacord 40 0453 7. Isacord 40 1154</p>		
<p>Nb039_48</p>			<p>↗ 97 x 127 mm 3.8 x 5 inch</p>		
<p>1. Isacord 40 1141 2. Isacord 40 0941 3. Isacord 40 5643</p>			<p>1. Isacord 40 1114 2. Isacord 40 1335 3. Isacord 40 5664</p>		



Übersicht Muster

Hg460_48	 92 x 98 mm 3.6 x 3.9 inch	 7.166
<ol style="list-style-type: none"> Isacord 40 3650 Isacord 40 0015 Isacord 40 1921 Isacord 40 3840 Isacord 40 3810 Isacord 40 4071 Isacord 40 3444 		



Verzierungen



Be790501	 199 x 276 mm 7.9 x 10.9 inch	 122.446
<ol style="list-style-type: none"> Isacord 40 0015 Isacord 40 2910 Isacord 40 0020 Isacord 40 3730 Isacord 40 3631 Isacord 40 3730 Isacord 40 0015 Isacord 40 2910 Isacord 40 0020 		



Wp428_48	 132 x 119 mm 5.2 x 4.7 inch	 9.580
<ol style="list-style-type: none"> Isacord 40 2920 Isacord 40 4101 Yenmet 7005 Isacord 40 5210 Isacord 40 5440 		

12576-05	 190 x 229 mm 7.5 x 9 inch	 39.218
<ol style="list-style-type: none"> Isacord 40 1332 Isacord 40 2022 Isacord 40 3444 		

12473-04	 94 x 184 mm 3.7 x 7.3 inch	 11.531
<ol style="list-style-type: none"> Isacord 40 5552 Isacord 40 5374 		

12620-12	 94 x 109 mm 3.7 x 4.3 inch	 9.673
<ol style="list-style-type: none"> Isacord 40 4114 		

















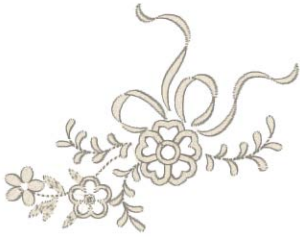











































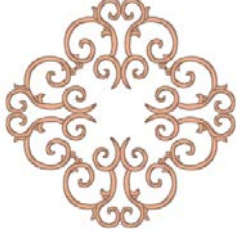











21008-15	 119 x 120 mm 4.7 x 4.7 inch	 14.999
<ol style="list-style-type: none"> Isacord 40 0504 Isacord 40 0542 Isacord 40 0132 		

82006-30	 100 x 174 mm 3.9 x 6.9 inch	 21.584
<ol style="list-style-type: none"> Isacord 40 0020 Isacord 40 4174 Isacord 40 0020 Isacord 40 4174 Isacord 40 0771 Isacord 40 0832 Isacord 40 0108 Isacord 40 4174 Isacord 40 0660 Isacord 40 1526 		

Be790503	 130 x 131 mm 5.1 x 5.1 inch	 8.816
<ol style="list-style-type: none"> Isacord 40 3541 		

<p>Be790504  121 x 121 mm 4.8 x 4.8 inch  4.900</p>	<p>Fb126  87 x 102 mm 3.4 x 4 inch  2.668</p>
<p>1.  Isacord 40 3611</p> 	<p>1.  Isacord 40 1220 2.  Isacord 40 1805</p> 
<p> 82005-01  176 x 109 mm 6.9 x 4.3 inch  13.171</p> <p>1.  Applique 1 2.  Applique 3 3.  Isacord 40 2830 4.  Isacord 40 0851 5.  Isacord 40 0870 6.  Isacord 40 5822 7.  Isacord 40 1753 8.  Isacord 40 2711 9.  Isacord 40 0851 10.  Applique 1 11.  Applique 3 12.  Isacord 40 2711 13.  Isacord 40 0851</p> 	<p> 21003-26  123 x 124 mm 4.8 x 4.9 inch  16.269</p> <p>1.  Isacord 40 0345 2.  Isacord 40 0442 3.  Isacord 40 0232</p> 
<p> 82006-36  122 x 123 mm 4.8 x 4.8 inch  21.745</p> <p>1.  Applique 1 2.  Applique 3 3.  Isacord 40 4421 4.  Isacord 40 0660 5.  Isacord 40 0832 6.  Isacord 40 4174 7.  Isacord 40 0108 8.  Isacord 40 4421</p> 	<p>Be790403  140 x 130 mm 5.5 x 5.1 inch  13.281</p> <p>1.  Isacord 40 0020 2.  Isacord 40 0731</p> 
<p>Nb018_48  90 x 97 mm 3.6 x 3.8 inch  11.158</p> <p>1.  Isacord 40 0945 2.  Isacord 40 1252 3.  Isacord 40 1161 4.  Isacord 40 4010 5.  Isacord 40 4122</p> 	<p>Nb728_48  97 x 112 mm 3.8 x 4.4 inch  4.836</p> <p>1.  Isacord 40 6051 2.  Isacord 40 2560</p> 
<p>Nb403_48  78 x 78 mm 3.1 x 3.1 inch  6.615</p> <p>1.  Isacord 40 0552 2.  Isacord 40 4032 3.  Isacord 40 4332</p> 	<p>Hg079_48  116 x 116 mm 4.6 x 4.6 inch  5.671</p> <p>1.  Isacord 40 5933 2.  Isacord 40 1913</p> 



























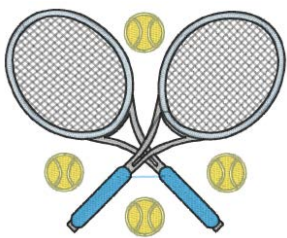

Übersicht Muster

Fb457_48  108 x 83 mm 4.2 x 3.3 inch  4.601	Fq881_48  129 x 129 mm 5.1 x 5.1 inch  7.877
1.  Isacord 40 0020 2.  Isacord 40 1172 	1.  Isacord 40 1061 2.  Isacord 40 0934 3.  Isacord 40 1172 4.  Isacord 40 5933 5.  Isacord 40 5610 6.  Isacord 40 2160 
Fb336_48  122 x 122 mm 4.8 x 4.8 inch  13.642	Fb377_48  121 x 92 mm 4.8 x 3.6 inch  6.220
1.  Isacord 40 0672 2.  Isacord 40 0776 3.  Isacord 40 2160 	1.  Isacord 40 4101 2.  Isacord 40 5613 3.  Isacord 40 4032 4.  Isacord 40 5613 
Fq870_48  122 x 105 mm 4.8 x 4.1 inch  7.485	Fb385_48  131 x 128 mm 5.1 x 5 inch  14.617
1.  Isacord 40 1061 2.  Isacord 40 0934 3.  Isacord 40 1172 4.  Isacord 40 1902 5.  Isacord 40 0506 6.  Isacord 40 0811 	1.  Isacord 40 3953 2.  Isacord 40 1355 3.  Isacord 40 5934 4.  Isacord 40 1355 5.  Isacord 40 3953 
Fq072_48  80 x 102 mm 3.1 x 4 inch  8.114	Nb101_48  99 x 99 mm 3.9 x 3.9 inch  10.455
1.  Isacord 40 1430 	1.  Isacord 40 1311 
Nb373_48  121 x 177 mm 4.8 x 7 inch  9.769	Ws649_48  125 x 248 mm 4.9 x 9.8 inch  22.270
1.  Isacord 40 4531 	1.  Isacord 40 3962 2.  Isacord 40 3910 3.  Isacord 40 3901 
Nb708_48  138 x 128 mm 5.4 x 5 inch  3.677	Fb433_48  121 x 121 mm 4.8 x 4.8 inch  16.809
1.  Isacord 40 0111 2.  Isacord 40 4174 	1.  Isacord 40 3130 2.  Isacord 40 3150 3.  Isacord 40 4240 

















































































Sport und Hobby





















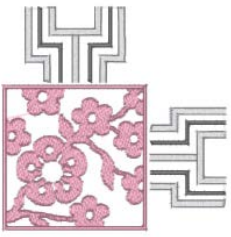











<p>Be790601  80 x 80 mm 3.2 x 3.1 inch  12.560</p>	<p>Be790602  80 x 75 mm 3.1 x 3 inch  10.169</p>
<p>1.  Isacord 40 4133 2.  Isacord 40 0800</p> 	<p>1.  Isacord 40 5643 2.  Isacord 40 5912 3.  Isacord 40 0015</p> 
<p> 12611-08  80 x 120 mm 3.1 x 4.7 inch  5.770</p>	<p> 12611-18  130 x 158 mm 5.1 x 6.2 inch  8.045</p>
<p>1.  Applique 1 2.  Applique 2 3.  Applique 1 4.  Applique 2 5.  Isacord 40 1154 6.  Isacord 40 5440 7.  Isacord 40 1902</p> 	<p>1.  Applique 1 2.  Applique 2 3.  Isacord 40 0151 4.  Isacord 40 5440</p> 
<p>Be790603  80 x 75 mm 3.2 x 2.9 inch  11.824</p>	<p>Be790604  80 x 80 mm 3.1 x 3.2 inch  20.838</p>
<p>1.  Isacord 40 0015 2.  Isacord 40 3654</p> 	<p>1.  Isacord 40 0660 2.  Isacord 40 1233 3.  Isacord 40 0660</p> 
<p>Be790605  80 x 80 mm 3.1 x 3.1 inch  14.136</p>	<p>Be790606  100 x 86 mm 3.9 x 3.4 inch  7.445</p>
<p>1.  Isacord 40 0015 2.  Isacord 40 3363 3.  Isacord 40 4116 4.  Isacord 40 0020</p> 	<p>1.  Isacord 40 0020 2.  Isacord 40 1306</p> 
<p>Be790607  80 x 74 mm 3.1 x 2.9 inch  6.046</p>	<p>Be790608  80 x 80 mm 3.2 x 3.1 inch  7.937</p>
<p>1.  Isacord 40 1115</p> 	<p>1.  Isacord 40 0020</p> 

Übersicht Muster

Sp980  63 x 64 mm 2.5 x 2.5 inch  11.286	Nb036  36 x 70 mm 1.4 x 2.8 inch  3.909
<ol style="list-style-type: none"> 1. Isacord 40 0015 2. Isacord 40 0142 3. Isacord 40 0020 	<ol style="list-style-type: none"> 1. Isacord 40 3770 2. Isacord 40 0131 3. Isacord 40 0622 4. Isacord 40 0015 
Rc244  88 x 53 mm 3.5 x 2.1 inch  12.558	Rc675  102 x 80 mm 4 x 3.1 inch  10.667
<ol style="list-style-type: none"> 1. Isacord 40 0020 2. Isacord 40 3600 3. Isacord 40 4230 4. Yenmet 7005 5. Isacord 40 3910 6. Isacord 40 1902 7. Isacord 40 1912 8. Isacord 40 0108 9. Isacord 40 0020 10. Isacord 40 0015 11. Isacord 40 0124 	<ol style="list-style-type: none"> 1. Isacord 40 0853 2. Isacord 40 4174 3. Isacord 40 0142 4. Isacord 40 1061 5. Isacord 40 1565 6. Isacord 40 0111 7. Isacord 40 3971 8. Isacord 40 1172 9. Isacord 40 0842 10. Isacord 40 0940 11. Isacord 40 0101 12. Isacord 40 3840 13. Isacord 40 0015 14. Isacord 40 3652 15. Isacord 40 4174 16. Isacord 40 0142 
Sp266  76 x 54 mm 3 x 2.1 inch  3.690	Sp989  102 x 82 mm 4 x 3.2 inch  10.827
<ol style="list-style-type: none"> 1. Isacord 40 1902 2. Isacord 40 3600 	<ol style="list-style-type: none"> 1. Isacord 40 4174 2. Isacord 40 0142 3. Isacord 40 3901 4. Isacord 40 3962 5. Isacord 40 0506 6. Isacord 40 0520 7. Isacord 40 0020 
Sr067  87 x 97 mm 3.4 x 3.8 inch  16.143	Lt870  97 x 57 mm 3.8 x 2.2 inch  10.380
<ol style="list-style-type: none"> 1. Isacord 40 3910 2. Isacord 40 0706 3. Isacord 40 4531 4. Isacord 40 4430 5. Isacord 40 1106 6. Isacord 40 0501 7. Isacord 40 5500 8. Isacord 40 0020 9. Isacord 40 4010  	<ol style="list-style-type: none"> 1. Isacord 40 3650 2. Isacord 40 0015 3. Isacord 40 0150 4. Isacord 40 1902 5. Isacord 40 0853 6. Isacord 40 1565 7. Isacord 40 0020 8. Isacord 40 0142 9. Isacord 40 2171 
Sr589  95 x 66 mm 3.7 x 2.6 inch  14.868	Fb158  39 x 53 mm 1.6 x 2.1 inch  2.889
<ol style="list-style-type: none"> 1. Isacord 40 0142 2. Isacord 40 1220 3. Isacord 40 1332 4. Isacord 40 1334 5. Isacord 40 3611 6. Isacord 40 1800 7. Isacord 40 0015 8. Isacord 40 4174 	<ol style="list-style-type: none"> 1. Isacord 40 1123 2. Isacord 40 0861 3. Isacord 40 2363 4. Isacord 40 1755 5. Isacord 40 0131 

































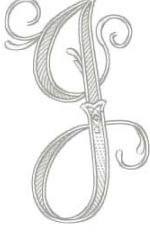







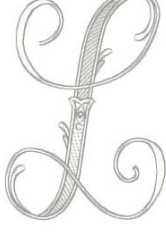



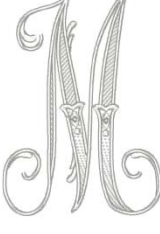

Asia

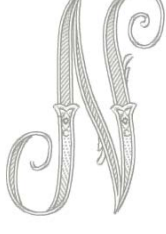





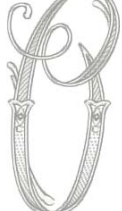

































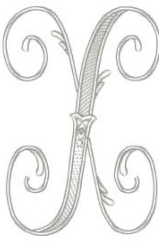





Nb124_48	 172 x 132 mm 6.8 x 5.2 inch	 46.607	BE790801	 129 x 131 mm 5.1 x 5.1 inch	 11.306
<ol style="list-style-type: none"> 1.  Isacord 40 0101 2.  Isacord 40 0640 3.  Isacord 40 6141 4.  Isacord 40 5833 5.  Isacord 40 0221 6.  Isacord 40 2022 7.  Isacord 40 1730 8.  Isacord 40 1114 9.  Isacord 40 2022 		<ol style="list-style-type: none"> 1.  Isacord 40 0851 			
BE790802	 36 x 117 mm 1.4 x 4.6 inch	 9.166	BE790803	 36 x 350 mm 1.4 x 13.8 inch	 17.193
<ol style="list-style-type: none"> 1.  Isacord 40 0851 		<ol style="list-style-type: none"> 1.  Isacord 40 0851 			
Fq212_48	 62 x 62 mm 2.4 x 2.4 inch	 5.308	Fb492_48	 87 x 293 mm 3.4 x 11.5 inch	 28.865
<ol style="list-style-type: none"> 1.  Isacord 40 0941 2.  Isacord 40 0940 3.  Isacord 40 1725 4.  Isacord 40 1913 5.  Yenmet 7011 		<ol style="list-style-type: none"> 1.  Isacord 40 0132 2.  Isacord 40 0015 3.  Isacord 40 2250 4.  Isacord 40 2363 5.  Isacord 40 2560 6.  Isacord 40 2155 7.  Isacord 40 2153 8.  Isacord 40 0713 9.  Isacord 40 0142 10.  Isacord 40 0643 	<ol style="list-style-type: none"> 11.  Isacord 40 2152 		
Fq194_48	 120 x 118 mm 4.7 x 4.7 inch	 21.749	Fq217_48	 85 x 59 mm 3.3 x 2.3 inch	 7.250
<ol style="list-style-type: none"> 1.  Isacord 40 1600 2.  Isacord 40 0940 3.  Isacord 40 0622 4.  Isacord 40 0941 5.  Isacord 40 1725 6.  Isacord 40 1913 7.  Yenmet 7011 		<ol style="list-style-type: none"> 1.  Isacord 40 0941 2.  Isacord 40 0622 3.  Isacord 40 1725 4.  Isacord 40 1913 5.  Yenmet 7011 6.  Isacord 40 1600 			
Fa427	 112 x 66 mm 4.4 x 2.6 inch	 13.208	Fb276_48	 125 x 112 mm 4.9 x 4.4 inch	 5.521
<ol style="list-style-type: none"> 1.  Isacord 40 1134 2.  Isacord 40 0670 3.  Isacord 40 0861 4.  Isacord 40 0873 5.  Isacord 40 1134 6.  Isacord 40 1355 7.  Isacord 40 1800 		<ol style="list-style-type: none"> 1.  Isacord 40 3622 2.  Isacord 40 3652 			

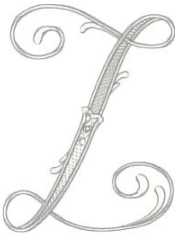















Fb283_48  102 x 109 mm 4 x 4.3 inch  3.721	Fb490_48  68 x 68 mm 2.7 x 2.7 inch  8.023
1.  Isacord 40 3622 2.  Isacord 40 3711 	1.  Isacord 40 2152 2.  Isacord 40 0142 3.  Isacord 40 0112 
Fb491_48  32 x 166 mm 1.2 x 6.5 inch  10.632	Nb491_48  79 x 168 mm 3.1 x 6.6 inch  5.286
1.  Isacord 40 2152 2.  Isacord 40 0142 3.  Isacord 40 0112 	1.  Isacord 40 1900 
Fb484_48  67 x 59 mm 2.6 x 2.3 inch  3.836	Wp423_48  90 x 158 mm 3.6 x 6.2 inch  12.132
1.  Isacord 40 0643 	1.  Isacord 40 0131 2.  Isacord 40 0020 3.  Isacord 40 1102 4.  Isacord 40 1301 

Bezaubernde Monogramme

























12587-01  59 x 90 mm 2.3 x 3.5 inch  6.471	12587-02  52 x 90 mm 2.1 x 3.5 inch  6.938
1.  Isacord 40 0101 	1.  Isacord 40 0101 
12587-03  45 x 90 mm 1.8 x 3.5 inch  4.591	12587-04  57 x 90 mm 2.2 x 3.6 inch  6.580
1.  Isacord 40 0101 	1.  Isacord 40 0101 

12587-05  50 x 90 mm 2 x 3.6 inch  5.643	12587-06  57 x 90 mm 2.2 x 3.5 inch  5.439
1.  Isacord 40 0101 	1.  Isacord 40 0101 
12587-07  39 x 90 mm 1.5 x 3.6 inch  5.200	12587-08  62 x 90 mm 2.4 x 3.6 inch  7.850
1.  Isacord 40 0101 	1.  Isacord 40 0101 
12587-09  49 x 89 mm 1.9 x 3.5 inch  4.990	12587-10  57 x 89 mm 2.2 x 3.5 inch  6.021
1.  Isacord 40 0101 	1.  Isacord 40 0101 
12587-11  62 x 91 mm 2.4 x 3.6 inch  7.067	12587-12  63 x 90 mm 2.5 x 3.5 inch  5.116
1.  Isacord 40 0101 	1.  Isacord 40 0101 
12587-13  64 x 92 mm 2.5 x 3.6 inch  7.776	12587-14  63 x 90 mm 2.5 x 3.6 inch  7.400
1.  Isacord 40 0101 	1.  Isacord 40 0101 
12587-15  44 x 90 mm 1.7 x 3.5 inch  5.783	12587-16  63 x 89 mm 2.5 x 3.5 inch  7.336
1.  Isacord 40 0101 	1.  Isacord 40 0101 





































































































<p>12587-17  54 x 89 mm 2.1 x 3.5 inch  6.583</p>	<p>12587-18  64 x 90 mm 2.5 x 3.6 inch  7.491</p>
<p>1.  Isacord 40 0101</p> 	<p>1.  Isacord 40 0101</p> 
<p>12587-19  56 x 90 mm 2.2 x 3.6 inch  5.705</p>	<p>12587-20  57 x 90 mm 2.2 x 3.6 inch  5.318</p>
<p>1.  Isacord 40 0101</p> 	<p>1.  Isacord 40 0101</p> 
<p>12587-21  62 x 91 mm 2.4 x 3.6 inch  6.137</p>	<p>12587-22  64 x 91 mm 2.5 x 3.6 inch  5.277</p>
<p>1.  Isacord 40 0101</p> 	<p>1.  Isacord 40 0101</p> 
<p>12587-23  64 x 90 mm 2.5 x 3.6 inch  7.519</p>	<p>12587-24  62 x 91 mm 2.4 x 3.6 inch  5.684</p>
<p>1.  Isacord 40 0101</p> 	<p>1.  Isacord 40 0101</p> 
<p>12587-25  52 x 91 mm 2 x 3.6 inch  5.979</p>	<p>12587-26  68 x 89 mm 2.7 x 3.5 inch  5.047</p>
<p>1.  Isacord 40 0101</p> 	<p>1.  Isacord 40 0101</p> 
<p>12587-53  67 x 23 mm 2.6 x 0.9 inch  994</p>	<p>12587-54  50 x 107 mm 2 x 4.2 inch  3.910</p>
<p>1.  Isacord 40 0101</p> 	<p>1.  Isacord 40 0101</p> 

12587-55  70 x 144 mm 2.8 x 5.7 inch  7.108	12587-56  49 x 100 mm 1.9 x 3.9 inch  3.819
1.  Isacord 40 0101 	1.  Isacord 40 0101 
12587-57  57 x 20 mm 2.3 x 0.8 inch  1.459	12587-58  53 x 116 mm 2.1 x 4.6 inch  3.614
1.  Isacord 40 0101 	1.  Isacord 40 0101 
12587-59  33 x 94 mm 1.3 x 3.7 inch  2.321	12587-60  126 x 126 mm 5 x 5 inch  5.003
1.  Isacord 40 0101 	1.  Isacord 40 0101 
12587-61  36 x 29 mm 1.4 x 1.1 inch  2.091	12587-62  35 x 34 mm 1.4 x 1.3 inch  2.284
1.  Isacord 40 0101 	1.  Isacord 40 0101 

Tiere

Cm140_48  88 x 98 mm 3.5 x 3.8 inch  14.589	Cm142  56 x 66 mm 2.2 x 2.6 inch  4.588
1.  Isacord 40 6051 2.  Isacord 40 0453 3.  Isacord 40 5552 4.  Isacord 40 5822 5.  Isacord 40 0015 6.  Isacord 40 1902 7.  Isacord 40 1521 8.  Isacord 40 2022 9.  Isacord 40 2123 10.  Isacord 40 4174 11.  Isacord 40 0108 	1. Isacord 40 0015 2.  Isacord 40 0020 3.  Isacord 40 3953 4.  Isacord 40 2500 5.  Isacord 40 3040 6.  Isacord 40 0180 7.  Isacord 40 2830 8.  Isacord 40 3211 

Übersicht Muster

Fb258_48  83 x 184 mm 3.3 x 7.2 inch  14.817	Fq106  109 x 109 mm 4.3 x 4.3 inch  5.947
<ol style="list-style-type: none"> 1.  Isacord 40 5722 2.  Isacord 40 0532 3.  Isacord 40 0853 4.  Isacord 40 3951 5.  Isacord 40 6051 6.  Isacord 40 3762 7.  Isacord 40 0622 8.  Isacord 40 4174 9.  Isacord 40 3711 	<ol style="list-style-type: none"> 1.  Isacord 40 1911 2.  Isacord 40 1600 3.  Isacord 40 0822 
Fq617  118 x 198 mm 4.6 x 7.8 inch  29.928	Fq624  64 x 144 mm 2.5 x 5.7 inch  4.429
<ol style="list-style-type: none"> 1.  Isacord 40 3640 2.  Isacord 40 0015 3.  Isacord 40 0970 4.  Isacord 40 0640 5.  Isacord 40 0520 6.  Isacord 40 0731 7.  Isacord 40 1332 8.  Isacord 40 1311 9.  Isacord 40 3962 10.  Isacord 40 3820 11.  Isacord 40 3710 12.  Isacord 40 3902 13.  Isacord 40 4174 14.  Isacord 40 2920 15.  Isacord 40 2155 16.  Isacord 40 0600 17.  Isacord 40 2171 18.  Isacord 40 2155 19.  Isacord 40 2530 20.  Isacord 40 0232 21.  Isacord 40 5531 	<ol style="list-style-type: none"> 1.  Yenmet 7029 2.  Isacord 40 3820 3.  Isacord 40 2530 4.  Isacord 40 1102 5.  Isacord 40 4410 6.  Isacord 40 5610 7.  Isacord 40 5822 8.  Isacord 40 2152 9.  Isacord 40 0713 
Mt022_48  123 x 125 mm 4.9 x 4.9 inch  35.446	Mt028  103 x 93 mm 4.1 x 3.7 inch  14.192
<ol style="list-style-type: none"> 1.  Isacord 40 2810 2.  Isacord 40 2715 3.  Isacord 40 2101 4.  Isacord 40 3906 5.  Isacord 40 0015 6.  Isacord 40 1102 7.  Isacord 40 3962 8.  Isacord 40 0506 9.  Isacord 40 5722 10.  Isacord 40 2550 11.  Isacord 40 5912 12.  Isacord 40 0660 	<ol style="list-style-type: none"> 1.  Isacord 40 5722 2.  Isacord 40 0704 3.  Isacord 40 5912 4.  Isacord 40 3906 5.  Isacord 40 2550 6.  Isacord 40 2912 7.  Isacord 40 1703 8.  Isacord 40 0506 9.  Isacord 40 3962 10.  Isacord 40 2504 11.  Isacord 40 1102 
Wm785  85 x 103 mm 3.3 x 4.1 inch  11.450	Wp217  94 x 78 mm 3.7 x 3.1 inch  7.444
<ol style="list-style-type: none"> 1.  Isacord 40 0020 	<ol style="list-style-type: none"> 1.  Isacord 40 0101 2.  Isacord 40 4174 3.  Isacord 40 0020 4.  Isacord 40 0651 5.  Isacord 40 0152 6.  Isacord 40 0873 7.  Isacord 40 0861 8.  Isacord 40 0660 9.  Isacord 40 0934 10.  Isacord 40 5822 11.  Isacord 40 1725 

Wp244 137 x 172 mm 5.4 x 6.8 inch 20.653



1. Isacord 40 0142
2. Isacord 40 0108
3. Isacord 40 0221
4. Isacord 40 0101
5. Isacord 40 1010
6. Isacord 40 0811
7. Isacord 40 1311
8. Isacord 40 4174
9. Isacord 40 0124
10. Isacord 40 0132
11. Isacord 40 0722
12. Isacord 40 0761
13. Isacord 40 5822
14. Isacord 40 5633
15. Isacord 40 0132

Ws610_48 127 x 111 mm 5 x 4.4 inch 4.658



1. Isacord 40 1874

DesignWorks

Dw11 70 x 71 mm 2.8 x 2.8 inch 110

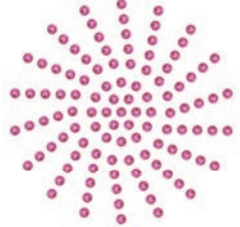

1. Swarovski 0502

Be790901 182 x 252 mm 7.1 x 9.9 inch 38.392



1. Edding 34
2. Edding 9
3. Edding 33
4. Edding 68
5. Edding 1

Be790903 181 x 293 mm 7.1 x 11.5 inch 11.366



1. Edding 19

Be790905 104 x 227 mm 4.1 x 8.9 inch 21.349



1. Edding 34
2. Edding 12
3. Edding 16
4. Edding 10
5. Edding 1

Be790906 192 x 196 mm 7.6 x 7.7 inch 21.054



1. Edding 8
2. Edding 3
3. Edding 5
4. Edding 34
5. Edding 69
6. Edding 10
7. Edding 5
8. Edding 9
9. Edding 11
10. Edding 65
11. Edding 12

Be790909 167 x 322 mm 6.6 x 12.7 inch 20.162



1. Edding 7

Dw07 114 x 152 mm 4.5 x 6 inch 198



1. Swarovski 0237

Dw05 105 x 94 mm 4.1 x 3.7 inch 13.334

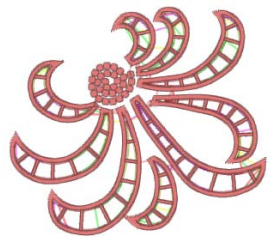

1. Isacord 40 2022
2. Cut 0001
3. Cut 0002
4. Cut 0003
5. Cut 0004
6. Isacord 40 2022

Dw10 119 x 119 mm 4.7 x 4.7 inch 5.939

1. Cut 0001
2. Cut 0002
3. Cut 0003
4. Cut 0004



Dw08 206 x 100 mm 8.1 x 3.9 inch 424

1. Swarovski 0501



Be700121 196 x 197 mm 7.7 x 7.8 inch 2.183

1. Isacord 40 3600
2. Isacord 40 1703



Be700122 119 x 37 mm 4.7 x 1.5 inch 4.124

1. Isacord 40 5833



Be700123 113 x 206 mm 4.4 x 8.1 inch 6.090

1. Punch 0004
2. Punch 0007



Be700124 141 x 134 mm 5.6 x 5.3 inch 6.184

1. Isacord 40 2300
2. Isacord 40 3901



Monogramme rosa

Be790101 75 x 89 mm 2.9 x 3.5 inch 4.971

1. Isacord 40 2320
2. Isacord 40 4620
3. Isacord 40 2152
4. Isacord 40 0111
5. Isacord 40 0352
6. Isacord 40 2220
7. Isacord 40 1903



Be790102 73 x 89 mm 2.9 x 3.5 inch 5.741

1. Isacord 40 2320
2. Isacord 40 4620
3. Isacord 40 2152
4. Isacord 40 0111
5. Isacord 40 0352
6. Isacord 40 2220
7. Isacord 40 1903



Be790103 64 x 93 mm 2.5 x 3.6 inch 4.800



1. Isacord 40 2320
2. Isacord 40 4620
3. Isacord 40 2152
4. Isacord 40 0111
5. Isacord 40 0352
6. Isacord 40 2220
7. Isacord 40 1903











Be790104 90 x 98 mm 3.6 x 3.8 inch 5.856



1. Isacord 40 2320
2. Isacord 40 4620
3. Isacord 40 2152
4. Isacord 40 0111
5. Isacord 40 0352
6. Isacord 40 2220
7. Isacord 40 1903











Be790105  61 x 90 mm
2.4 x 3.5 inch  5.361



1.  Isacord 40 2320
2.  Isacord 40 4620
3.  Isacord 40 2152
4.  Isacord 40 0111
5.  Isacord 40 0352
6.  Isacord 40 2220
7.  Isacord 40 1903











Be790106  64 x 90 mm
2.5 x 3.5 inch  4.953



1.  Isacord 40 2320
2.  Isacord 40 4620
3.  Isacord 40 2152
4.  Isacord 40 0111
5.  Isacord 40 0352
6.  Isacord 40 2220
7.  Isacord 40 1903











Be790107  80 x 90 mm
3.1 x 3.5 inch  5.290



1.  Isacord 40 2320
2.  Isacord 40 4620
3.  Isacord 40 2152
4.  Isacord 40 0111
5.  Isacord 40 0352
6.  Isacord 40 2220
7.  Isacord 40 1903











Be790108  71 x 90 mm
2.8 x 3.5 inch  5.936



1.  Isacord 40 2320
2.  Isacord 40 4620
3.  Isacord 40 2152
4.  Isacord 40 0111
5.  Isacord 40 0352
6.  Isacord 40 2220
7.  Isacord 40 1903









Be790109  32 x 101 mm
1.3 x 4 inch  4.429



1.  Isacord 40 2320
2.  Isacord 40 4620
3.  Isacord 40 2152
4.  Isacord 40 0111
5.  Isacord 40 0352
6.  Isacord 40 2220
7.  Isacord 40 1903





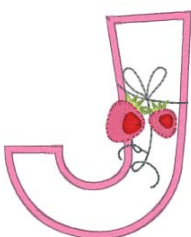



Be790110  73 x 89 mm
2.9 x 3.5 inch  4.782



1.  Isacord 40 2320
2.  Isacord 40 4620
3.  Isacord 40 2152
4.  Isacord 40 0111
5.  Isacord 40 0352
6.  Isacord 40 2220
7.  Isacord 40 1903





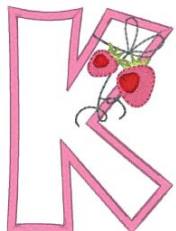



Be790111  65 x 89 mm
2.6 x 3.5 inch  5.957



1.  Isacord 40 2320
2.  Isacord 40 4620
3.  Isacord 40 2152
4.  Isacord 40 0111
5.  Isacord 40 0352
6.  Isacord 40 2220
7.  Isacord 40 1903





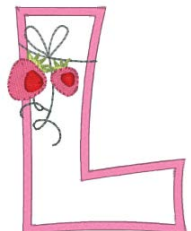





Be790112  70 x 90 mm
2.8 x 3.5 inch  4.725



1.  Isacord 40 2320
2.  Isacord 40 4620
3.  Isacord 40 2152
4.  Isacord 40 0111
5.  Isacord 40 0352
6.  Isacord 40 2220
7.  Isacord 40 1903









Be790113  89 x 90 mm
3.5 x 3.6 inch  5.534



1.  Isacord 40 2320
2.  Isacord 40 4620
3.  Isacord 40 2152
4.  Isacord 40 0111
5.  Isacord 40 0352
6.  Isacord 40 2220
7.  Isacord 40 1903





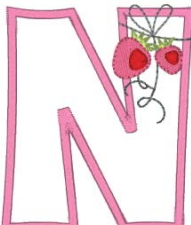



Be790114  76 x 91 mm
3 x 3.6 inch  6.341



1.  Isacord 40 2320
2.  Isacord 40 4620
3.  Isacord 40 2152
4.  Isacord 40 0111
5.  Isacord 40 0352
6.  Isacord 40 2220
7.  Isacord 40 1903





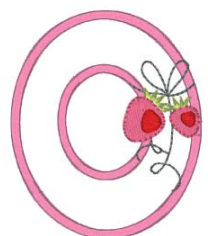





Be790115  75 x 90 mm
2.9 x 3.5 inch  5.494



1.  Isacord 40 2320
2.  Isacord 40 4620
3.  Isacord 40 2152
4.  Isacord 40 0111
5.  Isacord 40 0352
6.  Isacord 40 2220
7.  Isacord 40 1903



Be790116  71 x 103 mm
2.8 x 4.1 inch  5.408



1.  Isacord 40 2320
2.  Isacord 40 4620
3.  Isacord 40 2152
4.  Isacord 40 0111
5.  Isacord 40 0352
6.  Isacord 40 2220
7.  Isacord 40 1903



Be790117  82 x 101 mm
3.2 x 4 inch  6.212

1. Isacord 40 2320
2. Isacord 40 4620
3. Isacord 40 2152
4. Isacord 40 0111
5. Isacord 40 0352
6. Isacord 40 2220
7. Isacord 40 1903



Be790118  74 x 104 mm
2.9 x 4.1 inch  5.931



1. Isacord 40 2320
2. Isacord 40 4620
3. Isacord 40 2152
4. Isacord 40 0111
5. Isacord 40 0352
6. Isacord 40 2220
7. Isacord 40 1903



Be790119  60 x 89 mm
2.4 x 3.5 inch  5.256



1. Isacord 40 2320
2. Isacord 40 4620
3. Isacord 40 2152
4. Isacord 40 0111
5. Isacord 40 0352
6. Isacord 40 2220
7. Isacord 40 1903



Be790120  72 x 100 mm
2.8 x 3.9 inch  5.327

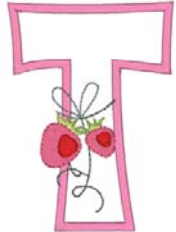

1. Isacord 40 2320
2. Isacord 40 4620
3. Isacord 40 2152
4. Isacord 40 0111
5. Isacord 40 0352
6. Isacord 40 2220
7. Isacord 40 1903



Be790121  78 x 90 mm
3.1 x 3.5 inch  5.588



1. Isacord 40 2320
2. Isacord 40 4620
3. Isacord 40 2152
4. Isacord 40 0111
5. Isacord 40 0352
6. Isacord 40 2220
7. Isacord 40 1903



Be790122  87 x 89 mm
3.4 x 3.5 inch  5.302

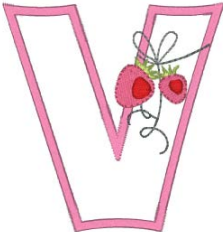

1. Isacord 40 2320
2. Isacord 40 4620
3. Isacord 40 2152
4. Isacord 40 0111
5. Isacord 40 0352
6. Isacord 40 2220
7. Isacord 40 1903



Be790123  105 x 89 mm
4.1 x 3.5 inch  5.930



1. Isacord 40 2320
2. Isacord 40 4620
3. Isacord 40 2152
4. Isacord 40 0111
5. Isacord 40 0352
6. Isacord 40 2220
7. Isacord 40 1903



Be790124  91 x 92 mm
3.6 x 3.6 inch  5.721

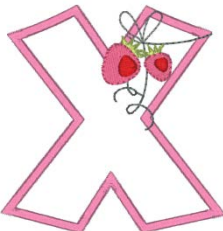

1. Isacord 40 2320
2. Isacord 40 4620
3. Isacord 40 2152
4. Isacord 40 0111
5. Isacord 40 0352
6. Isacord 40 2220
7. Isacord 40 1903

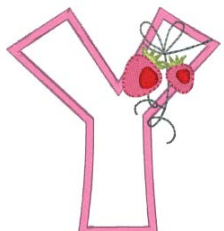

Be790125  84 x 89 mm
3.3 x 3.5 inch  4.866

1. Isacord 40 2320
2. Isacord 40 4620
3. Isacord 40 2152
4. Isacord 40 0111
5. Isacord 40 0352
6. Isacord 40 2220
7. Isacord 40 1903















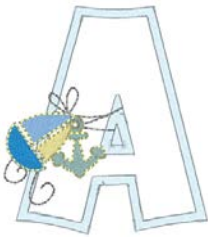











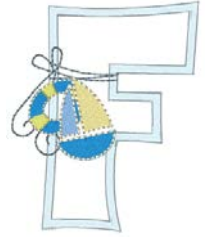





Be790126  56 x 89 mm
2.2 x 3.5 inch  5.386

1. Isacord 40 2320
2. Isacord 40 4620
3. Isacord 40 2152
4. Isacord 40 0111
5. Isacord 40 0352
6. Isacord 40 2220
7. Isacord 40 1903



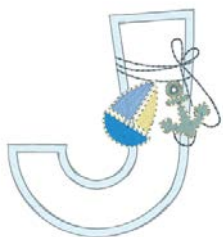

Monogramme blau

<p>Be790201  85 x 95 mm 3.3 x 3.8 inch  7.079</p>	<p>Be790202  80 x 96 mm 3.1 x 3.8 inch  7.644</p>
<p>1. Applique 1 2. Applique 2 3. Isacord 40 3963 4. Isacord 40 0111 5. Isacord 40 4752 6. Isacord 40 3900 7. Isacord 40 3630 8. Isacord 40 0232 9. Isacord 40 0630</p> 	<p>1. Applique 1 2. Applique 2 3. Isacord 40 3963 4. Isacord 40 3852 5. Isacord 40 3900 6. Isacord 40 0221 7. Isacord 40 3900 8. Isacord 40 3630 9. Isacord 40 0232 10. Isacord 40 0640</p> 
<p>Be790203  78 x 95 mm 3.1 x 3.8 inch  6.533</p>	<p>Be790204  104 x 96 mm 4.1 x 3.8 inch  7.274</p>
<p>1. Applique 1 2. Applique 2 3. Isacord 40 3963 4. Isacord 40 3852 5. Isacord 40 4752 6. Isacord 40 3900 7. Isacord 40 3630 8. Isacord 40 0232 9. Isacord 40 0630</p> 	<p>1. Applique 1 2. Applique 2 3. Isacord 40 3963 4. Isacord 40 3852 5. Isacord 40 4752 6. Isacord 40 3900 7. Isacord 40 3630 8. Isacord 40 0232 9. Isacord 40 0660</p> 
<p>Be790205  84 x 95 mm 3.3 x 3.8 inch  7.001</p>	<p>Be790206  78 x 96 mm 3.1 x 3.8 inch  7.088</p>
<p>1. Applique 1 2. Applique 2 3. Isacord 40 3963 4. Isacord 40 3852 5. Isacord 40 4752 6. Isacord 40 3900 7. Isacord 40 3630 8. Isacord 40 0232 9. Isacord 40 0660</p> 	<p>1. Applique 1 2. Applique 2 3. Isacord 40 3963 4. Isacord 40 3852 5. Isacord 40 3900 6. Isacord 40 0221 7. Isacord 40 3900 8. Isacord 40 3630 9. Isacord 40 0232 10. Isacord 40 0640</p> 
<p>Be790207  93 x 95 mm 3.6 x 3.8 inch  6.688</p>	<p>Be790208  88 x 95 mm 3.4 x 3.8 inch  7.845</p>
<p>1. Applique 1 2. Applique 2 3. Isacord 40 3963 4. Isacord 40 3852 5. Isacord 40 4752 6. Isacord 40 3900 7. Isacord 40 3630 8. Isacord 40 0232 9. Isacord 40 0660</p> 	<p>1. Applique 1 2. Applique 2 3. Isacord 40 3963 4. Isacord 40 3852 5. Isacord 40 3900 6. Isacord 40 0221 7. Isacord 40 3900 8. Isacord 40 3630 9. Isacord 40 0232 10. Isacord 40 0640</p> 
<p>Be790209  51 x 111 mm 2 x 4.4 inch  5.966</p>	<p>Be790210  89 x 96 mm 3.5 x 3.8 inch  5.977</p>
<p>1. Applique 1 2. Applique 2 3. Applique 1 4. Applique 2 5. Isacord 40 3963 6. Isacord 40 3852 7. Isacord 40 4752 8. Isacord 40 3900 9. Isacord 40 3630 10. Isacord 40 0232</p> 	<p>1. Applique 1 2. Applique 2 3. Isacord 40 3963 4. Isacord 40 3852 5. Isacord 40 4752 6. Isacord 40 3900 7. Isacord 40 3630 8. Isacord 40 0232 9. Isacord 40 0660</p> 

Be790211  75 x 95 mm
3 x 3.8 inch  6.908

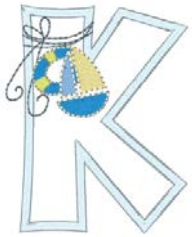

1. Applique 1
2. Applique 2
3. Isacord 40 3963
4. Isacord 40 3852
5. Isacord 40 3900
6. Isacord 40 0221
7. Isacord 40 3900
8. Isacord 40 3630
9. Isacord 40 0232
10. Isacord 40 0640



Be790212  83 x 95 mm
3.3 x 3.8 inch  6.145

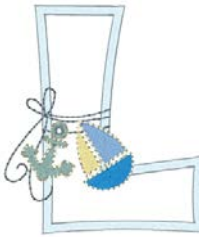

1. Applique 1
2. Applique 2
3. Isacord 40 3963
4. Isacord 40 3852
5. Isacord 40 4752
6. Isacord 40 3900
7. Isacord 40 3630
8. Isacord 40 0232
9. Isacord 40 0660



Be790213  100 x 101 mm
3.9 x 4 inch  7.211



1. Applique 1
2. Applique 2
3. Isacord 40 3963
4. Isacord 40 3852
5. Isacord 40 4752
6. Isacord 40 3900
7. Isacord 40 3630
8. Isacord 40 0232
9. Isacord 40 0660



Be790214  90 x 95 mm
3.5 x 3.7 inch  8.224



1. Applique 1
2. Applique 2
3. Isacord 40 3963
4. Isacord 40 3852
5. Isacord 40 3900
6. Isacord 40 0221
7. Isacord 40 3900
8. Isacord 40 3630
9. Isacord 40 0232
10. Isacord 40 0640



Be790215  88 x 95 mm
3.5 x 3.8 inch  6.684

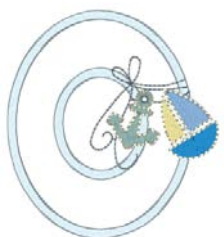

1. Applique 1
2. Applique 2
3. Isacord 40 3963
4. Isacord 40 3852
5. Isacord 40 4752
6. Isacord 40 3900
7. Isacord 40 3630
8. Isacord 40 0232
9. Isacord 40 0660



Be790216  72 x 95 mm
2.8 x 3.7 inch  5.906

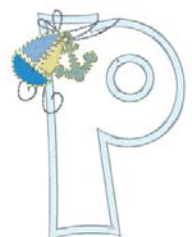

1. Applique 1
2. Applique 2
3. Isacord 40 3963
4. Isacord 40 3852
5. Isacord 40 4752
6. Isacord 40 3900
7. Isacord 40 3630
8. Isacord 40 0232
9. Isacord 40 0630



Be790217  86 x 102 mm
3.4 x 4 inch  7.327



1. Applique 1
2. Applique 2
3. Isacord 40 3963
4. Isacord 40 3852
5. Isacord 40 3900
6. Isacord 40 0221
7. Isacord 40 3900
8. Isacord 40 3630
9. Isacord 40 0232
10. Isacord 40 0640



Be790218  83 x 95 mm
3.3 x 3.7 inch  7.299



1. Applique 1
2. Applique 2
3. Isacord 40 3963
4. Isacord 40 3852
5. Isacord 40 4752
6. Isacord 40 3900
7. Isacord 40 3630
8. Isacord 40 0232
9. Isacord 40 0630



Be790219  79 x 95 mm
3.1 x 3.8 inch  6.541



1. Applique 1
2. Applique 2
3. Isacord 40 3963
4. Isacord 40 3852
5. Isacord 40 4752
6. Isacord 40 3900
7. Isacord 40 3630
8. Isacord 40 0232
9. Isacord 40 0660











Be790220  69 x 95 mm
2.7 x 3.8 inch  6.635



1. Applique 1
2. Applique 2
3. Isacord 40 3963
4. Isacord 40 3852
5. Isacord 40 3900
6. Isacord 40 0221
7. Isacord 40 3900
8. Isacord 40 3630
9. Isacord 40 0232
10. Isacord 40 0640





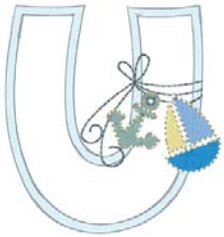





Be790221  90 x 96 mm
3.5 x 3.8 inch  7.297



1.  Applique 1
2.  Applique 2
3.  Isacord 40 3963
4.  Isacord 40 3852
5.  Isacord 40 4752
6.  Isacord 40 3900
7.  Isacord 40 3630
8.  Isacord 40 0232
9.  Isacord 40 0660





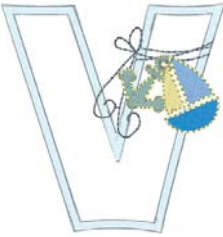







Be790222  93 x 96 mm
3.7 x 3.8 inch  7.259



1.  Applique 1
2.  Applique 2
3.  Isacord 40 3963
4.  Isacord 40 3852
5.  Isacord 40 4752
6.  Isacord 40 3900
7.  Isacord 40 3630
8.  Isacord 40 0232
9.  Isacord 40 0630











Be790223  115 x 95 mm
4.5 x 3.8 inch  7.640



1.  Applique 1
2.  Applique 2
3.  Isacord 40 3963
4.  Isacord 40 3852
5.  Isacord 40 3900
6.  Isacord 40 0221
7.  Isacord 40 3900
8.  Isacord 40 3630
9.  Isacord 40 0232
10.  Isacord 40 0640





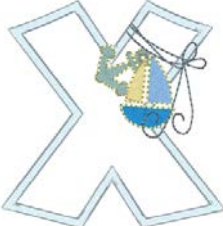







Be790224  93 x 95 mm
3.7 x 3.8 inch  7.340



1.  Applique 1
2.  Applique 2
3.  Isacord 40 3963
4.  Isacord 40 4752
5.  Isacord 40 3900
6.  Isacord 40 3630
7.  Isacord 40 0232
8.  Isacord 40 0630
9.  Isacord 40 3852













Be790225  89 x 95 mm
3.5 x 3.8 inch  5.793

1.  Applique 1
2.  Applique 2
3.  Isacord 40 3963
4.  Isacord 40 3852
5.  Isacord 40 4752
6.  Isacord 40 3900
7.  Isacord 40 3630
8.  Isacord 40 0232
9.  Isacord 40 0660



Be790226  59 x 96 mm
2.3 x 3.8 inch  6.774

1.  Applique 1
2.  Applique 2
3.  Isacord 40 3963
4.  Isacord 40 3852
5.  Isacord 40 3900
6.  Isacord 40 0221
7.  Isacord 40 3900
8.  Isacord 40 3630
9.  Isacord 40 0232
10.  Isacord 40 0640

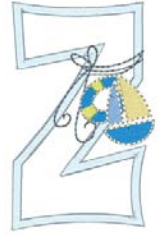

Index

D

Daten wiederherstellen	84
Display kalibrieren.....	55
Displayhelligkeit einstellen.....	54

E

eco-Modus verwenden	58
Eigene Einstellungen wählen.....	53

F

Fadenablaufscheibe einsetzen	34
Fadenrückstände unter der Stichplatte entfernen	85
Fehlermeldungen	89
Firmware	
Funktion aktivieren/deaktivieren	23
Navigation	23
Werte anpassen	24
Firmware aktualisieren	84
Firmwareversion prüfen	84
Freie Punktepositionierung	69
Funktion aktivieren/deaktivieren	23
Fussanlasser anschliessen	31

G

Geschwindigkeit regulieren	59
Greifer ölen	86
Greifer reinigen.....	85
Grundeinstellungen wiederherstellen	55

H

Händlerdaten eintragen	56
Hilfe aufrufen	58

K

Kindersicherung.....	58
Kombinationsmodus.....	70

M

Maschine entsorgen.....	96
Maschine lagern	96

N

Nadel nach oben/unten stellen.....	33
Nadel, Faden, Stoff	25
Nadel-Faden-Verhältnis	26
Nählicht einschalten.....	32

Nählicht einstellen	55
Navigation	23
Netzkabel	31
USA/Kanada.....	31

O

Oberfaden einfädeln	37
Oberfadenwächter einstellen	53

P

Pflege und Reinigung.....	85
---------------------------	----

R

Rasterpunktpositionierung	68
---------------------------------	----

S

Schriftzug bearbeiten.....	73
Schriftzug erstellen	73
Servicedaten speichern	57
Sicherheitshinweise.....	7
Sparmodus	58
Sprache wählen	54
Spulennetz verwenden	34
Stichplatte montieren	37
Stickberater aufrufen	58
Stickdateiformat	27
Stickdichte ändern	63
Stickmodul anschliessen.....	43
Stickmuster kombinieren	70
Stickmuster wählen	44
Stickmustergrösse proportional ändern	62
Stickmustergrösse unproportional ändern	62
Sticknadel montieren	35
Stickprobe	28
Stickrahmen justieren	50
Stickrahmen montieren.....	47
Stickrahmen virtuell positionieren	49
Störungsbehebung	93
Symbolerklärung.....	10

T

Technische Daten	97
Ton einstellen	54
Tutorial aufrufen.....	58

U

Übersicht Nadeln	25
Übersicht Stickmodul	21
Übersicht Stickmuster	98
Umweltschutz	9
Unterfaden einfädeln	41
Unterfadenwächter einstellen	53

W

Werte anpassen	24
----------------------	----



BERNINA empfiehlt Fäden von *Mettler*[®]

BERNINA International AG | CH-8266 Steckborn Switzerland | www.bernina.com | © Copyright by BERNINA International AG

0371485.20A.01
2023-01 DE

made to create **BERNINA**