

Dear «aurora» Customer

BERNINA has added another great sewing and embroidery computer to the very successful aurora product line. The new aurora 450 has a new hook system which enables you dear BERNINA customer to make wider stitches.

Now BERNINA offers three different aurora models – the BERNINA customer can choose their perfect sewing and embroidery computer according to her needs and wishes. All aurora models have the capability to add the world famous BERNINA Stitch Regulator. The aurora 440 QE has this great presser foot included in the standard accessories.

The aurora 430 / 440 QE / 450 are designed to give you the best sewing features possible. If you choose to expand your creative possibilities by exploring the world of embroidery, you can connect your sewing computer to your home PC and purchase an embroidery module from your BERNINA Dealer, and you can become an embroidery virtuoso.

I wish you great satisfaction and a wonderful experience with your new aurora sewing and embroidery computer.



H.P. Ueltschi
President

H. P. Ueltschi

BERNINA International AG
CH - 8266 Steckborn
www.bernina.com

BERNINA⁺

IMPORTANT SAFETY INSTRUCTIONS !



When using an electrical appliance, basic safety precautions should always be followed, including the following:

Read all instructions before using this sewing computer. When the sewing computer is not in use, it should be disconnected from the electricity supply by removing the plug from the outlet.

DANGER

To reduce the risk of electrical shock:

1. An appliance should never be left unattended when plugged in.
2. Always unplug this sewing computer from the electrical outlet immediately after using and before cleaning.

WARNING

To reduce the risk of burns, fire, electrical shock or injury to persons:

1. Do not allow to be used as a toy. Close attention is necessary when this sewing computer is used by or near children and infirm persons. This sewing computer is not intended for use by persons (including children) with reduced physical, sensory or mental capabilities, or lack of experience and knowledge, unless they have been given supervision or instruction concerning use of the sewing computer by a person responsible for their safety. Children should be supervised to ensure that they do not play with the sewing computer.
2. Use this sewing computer only for its intended use as described in this manual. Use only attachments recommended by the manufacturer as contained in this manual.
3. Never operate this sewing computer if:
 - it has a damaged cord or plug,
 - it is not working properly
 - it has been dropped or damaged,
 - it has fallen into water
 Return the sewing computer to the nearest authorized BERNINA dealer or service center for examination, repair, electrical or mechanical adjustment.
4. Never operate the sewing computer with any air vents blocked. Keep ventilation openings of the sewing computer and foot controller free from accumulation of lint, dust and fabric remnants and the like.

5. Keep fingers away from all moving parts. Special care is required around the sewing needle.
6. Always use the BERNINA original stitch plate. The wrong plate can cause needle breakage.
7. Do not use bent needles.
8. Do not pull or push fabric while stitching, this may deflect the needle, causing it to break.
9. Turn power switch to «0» (off) when making any adjustments in the needle area, such as threading or changing the needle, threading the bobbin or changing the presser foot etc.
10. Always unplug the sewing computer from the electrical outlet when removing covers, lubricating or when making any other user servicing adjustments mentioned in this instruction manual.
11. Never drop or insert any object into any openings on the sewing computer.
12. Do not use the sewing computer outdoors.
13. Do not operate where aerosol (spray) products are being used or where oxygen is being administered.
14. To disconnect, turn all controls to the off («0») position then remove the plug from the outlet.
15. Do not unplug by pulling on the cord, instead, grasp the plug before pulling.
16. No responsibility will be taken on behalf of **BERNINA** for any possible damage as the result of misuse of the sewing computer.
17. Under no circumstances should the sewing computer be left unattended when using the embroidery module.
18. This sewing computer is provided with double insulation (except USA / Canada). Use only identical replacement parts. See instructions for servicing of double-insulated machines.

SERVICING DOUBLE-INSULATED PRODUCTS

In a double-insulated product, two systems of insulation are provided instead of grounding. No grounding means is provided on a double-insulated product nor should a means for grounding be added to the product. Servicing a double-insulated product requires extreme care and knowledge of the system and should only be done by qualified service personnel. Replacement parts for a double-insulated product must be identical to those parts in the product. A double insulated product is marked with the words «DOUBLE INSULATION» or «DOUBLE INSULATED».

The symbol  may also be marked on the product.

This sewing and embroidery computer is intended for household use only.

SAVE THESE INSTRUCTIONS!

Your sewing computer 4 - 22

Accessories	4-7
Details aurora 430 / 440 QE / 450	8-9
Setting up the sewing computer	10-17
Thread tension	17
Important facts on threads and needles	18-19
Stitch plate, Feed dog and Fabric feed	20-21
Presser foot pressure, Balance	22
Cleaning / Trouble shooting	57-58

Display 23 - 29

Display	23
Function buttons	24-25
Memory	26-29

Applications 30 - 56

Stitch selection 430 / 440 QE / 450	30-32
Temporary altered stitch memory	33
Application of practical stitches, Quilt stitches, Decorative stitches	34-47
Buttonholes - Important information	48
Application of buttonholes / Eyelets / Button sew - on	49-56

All about embroidery 59 - 80

Details	59
Accessories	60-62
Setting up the embroidery computer	63-67
Important embroidery information	67-69
Embroidery operating requirements	70
Bernina embroidery software	70-71
Software - EC on PC	72-77
Starting to embroider	78
Mega-Hoop	79-80
Stitch summary	81-83

Index 84 - 85

Key to signs



Supplementary information!



Additional information on the corresponding subject you will find on the relevant page.



Helpful tips!



Please refer to the safety instructions! Risk of injury!



**Very important!
Risk of damage!**

All rights reserved.
In order to improve the product, and for our customers' benefit, all of the sewing and embroidery computer's features, parts, and accessories are subject to unannounced changes and alterations at any time.

Text

Herbert Stolz

Drawings

Müller-Melzer ID, Kreuzlingen

Design concept

Susanne Ribl

Copyright

2008 BERNINA International AG, Steckborn

Accessories

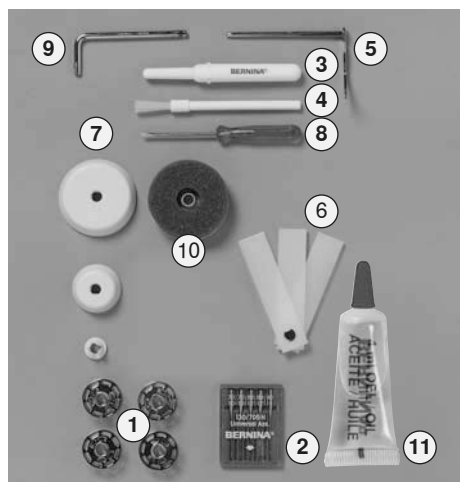

Standard accessories:

- 1 5 bobbins (one in bobbin case)
- 2 Needle selection 130/705H
- 3 Seam ripper
- 4 Brush
- 5 Seam guide
- 6 Height compensating tool
- 7 3 spool discs
- 8 Small screwdriver
- 9 Angular torx key
- 10 Foam pad
- 11 Oiler filled

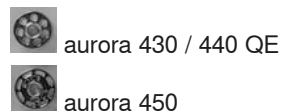

Accessories

- foot control
- instruction manual
- power cable
- warranty card
- Free Hand System presser foot lifter
- slide-on table
- seam guide for slide-on table
- Instructional presentation CD-ROM

Presser feet*



- 1_{430/440}, 1C₄₅₀**
Reverse pattern foot
 Straight stitch
 Practical and decorative stitch
 Quilt stitch
 • Eyelets
 • Securing



- 2₄₃₀, 2A₄₅₀**
Overlock foot
 Overlock seam,
 Overlock hem,
 Narrow satin stitch
 • For knits and wovens
 • Edge finishing



- 3A**
Automatic buttonhole foot with slide
 Buttonholes on smooth fabrics,
 Darning



- 4**
Zipper foot
 Sewing in zippers,
 Straight stitch



- 5**
Blindstitch foot
 Blind hem,
 Edge stitching,
 Straight stitch
 Blindstitch
 • for hems and blindstitch applique



- 9**
Darning foot
 Darning, Mono-grams or freehand embroidery
 Straight stitch,
 Basting stitch
 • Darning
 • sewing on buttons



- 20₄₄₀, 20C₄₅₀**
Open embroidery foot
 Embroidery,
 Appliqué, Satin stitch seams,
 Monograms



- 37₄₄₀**
Patchwork foot
 1/4" / 6mm
 Patchwork with 1/4" or 1/8" (6mm/3mm) seam allowance



- 42₄₄₀**
BSR foot
 Straight stitch, Freehand quilting

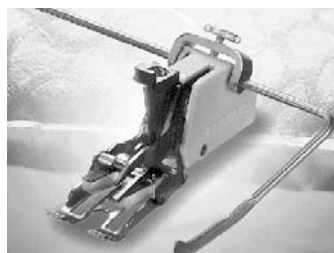

- 50₄₄₀**
Walking foot
 For fabrics which stick or tend to slip; Quilting,
 Straight stitch, Quilt stitch
 Decorative stitch
 • sewing difficult fabrics, e.g. velvets, matching plaids, squares, etc.



- Compensation plate for sewing buttonholes****
 Improves the fabric feed when sewing buttonholes in difficult fabrics

* can vary from country to country

** Optional accessories

Accessory box 430 / 440 QE Accessory box 450

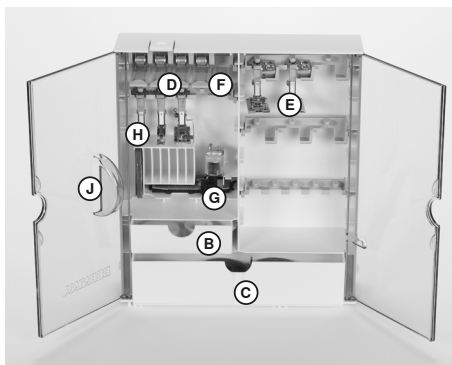
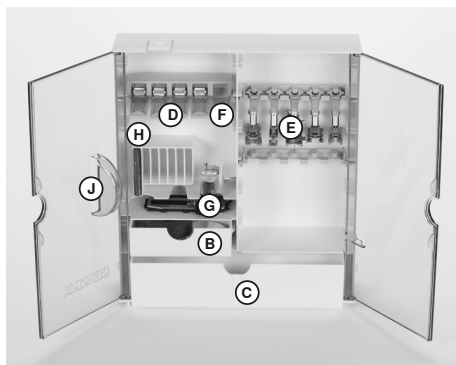

Free standing accessory box

- On the back of the box, pull both feet out until they click into place
- stand box in desired position

Storing accessories

Standard accessories are supplied in a plastic bag. The box is equipped with one small and one large drawer (**B** and **C**) as well as compartments for bobbin holders **D** and presser feet **E**. (Additional compartments and drawers are available as optional extras).

- push the bobbins into the compartments provided
- to remove a bobbin, press the compartment holder **F** lightly
- insert presser foot into holder **E**
- Buttonhole foot with slide no. 3A can be stored in compartment **G**
- the needle selection box can be stored in compartment **H**

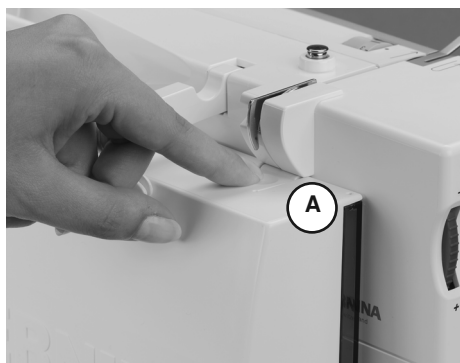

Attaching the accessory box to the sewing computer

- close the doors
- push feet back into position
- attach the box to the sewing computer (catch **A** must engage); inserting the presser foot lifter into the opening **J**

Removing the accessory box

- press catch **A** on the top of the box
- remove box to the rear



First lower the presser foot lifter!

Reinforced soft cover



- protects from dust and dirt
- protects sewing computer when transporting
- compartments for accessories



The cover and accessory box come with the sewing computer. The cover should be used to protect the sewing computer when it is not in use. The foot control, power cable, sewing table and instruction manual can be stored in the cover.

Optional accessories

BERNINA Specialty Presser Feet

The standard selection of presser feet covers most normal sewing requirements, but we recommend the use of BERNINA specialty presser feet for specific sewing tasks such as quilting, heirloom sewing, home decorating, tailoring, etc. They are available from your BERNINA dealer.



3
Buttonhole foot
Buttonholes

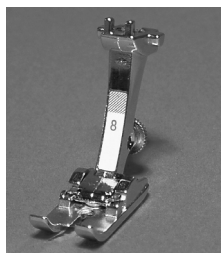

8
Jeans foot
Straight stitching in thick, firm fabrics



10C/10
Edge stitch foot
Straight stitch
• *Stitching edges*

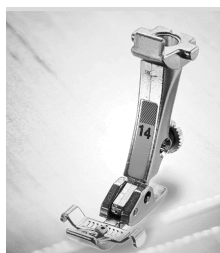

14
Zipper foot with guide
Sewing in zippers, Straight stitch



18
Button sew-on foot
Sewing on buttons, hooks and eyes



21
Braiding foot
Zig-zag stitch
• *Couching with wool to 3mm or light cord*



32
Pintuck foot
Straight stitch
• *Sewing pintucks in fine fabrics*



35
Invisible zipper foot
Sewing in zippers, Straight stitch



39
Embroidery foot
Zig-zag stitch, Decorative stitches
• *Buttonhole seams*
• *sewing decorative stitches*



43
Freemotion couching foot
Straight stitch
• *Attaching cords in a curved effect*



57
Patchwork foot with guide 1/4" / 6mm
Patchwork with 1/4" or 1/8" (6mm/3mm) seam allowance



Punching-Kit only 430/440 QE
Straight stitch
• *felting*



Lens set
We recommend to use the BERNINA lens set for more sewing comfort (better view of needle area).

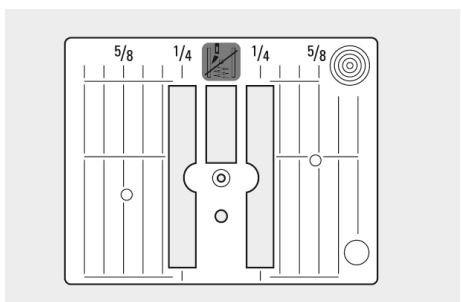

Straight Stitch Plate 450

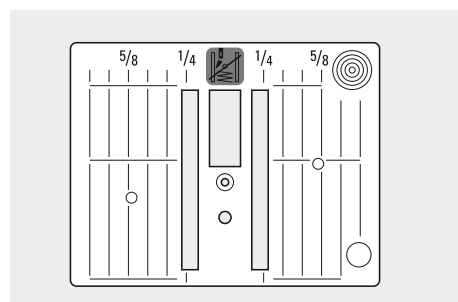

Straight Stitch Plate 430 / 440 QE

Details

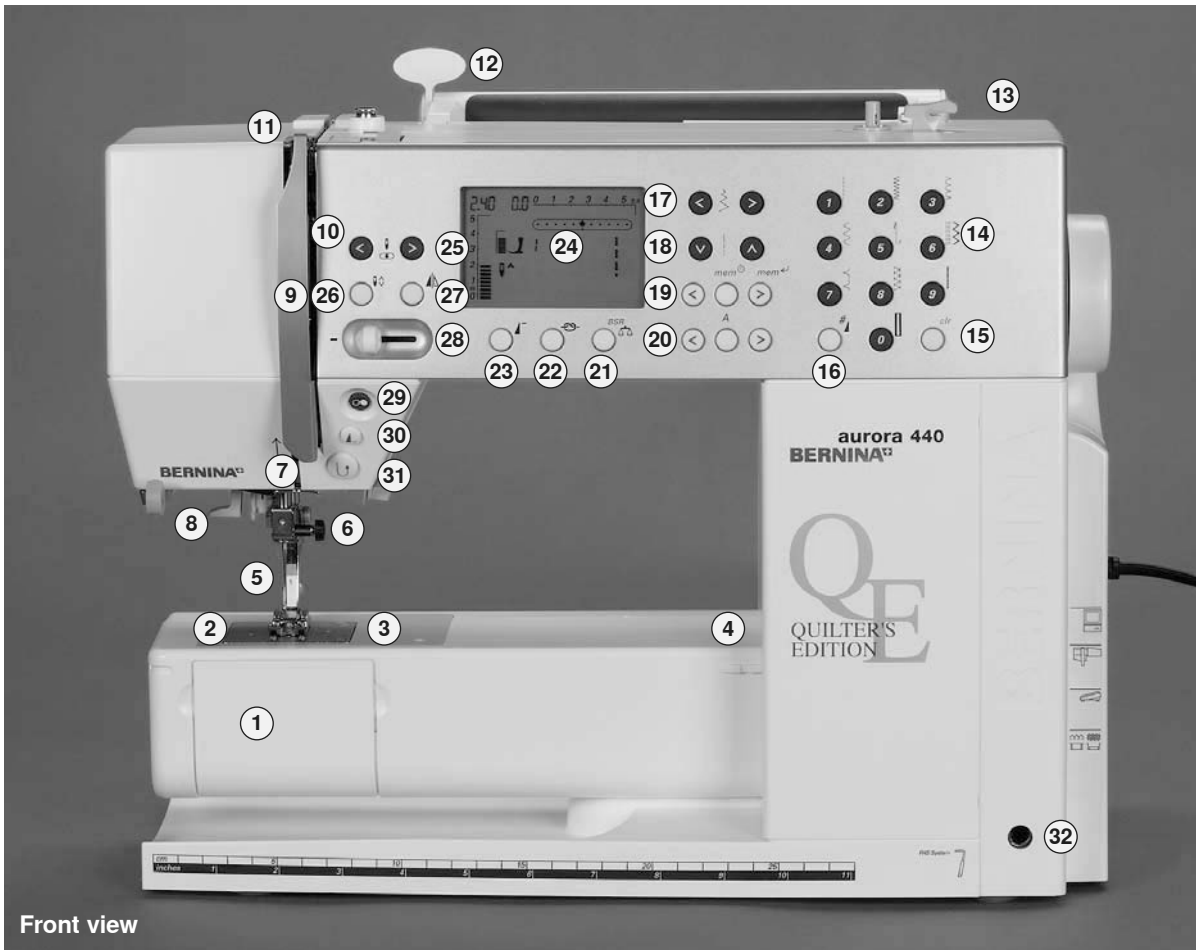

Front view

- 1 Bobbin cover
- 2 Stitch plate
- 3 Attachment base for special accessories
- 4 Darning hoop connection
- 5 Presser foot
- 6 Needle clamp
- 7 Thread guide
- 8 Needle threader
- 9 Thread take-up cover
- 10 Thread path
- 11 Thread take-up
- 12 Holder for stitch card
- 13 Bobbin winder with on/off switch and thread cutter
- 14 Stitch selection buttons
- 15 «clr» (clear) button
- 16 #-button (hash)
- 17 Stitch width buttons
- 18 Stitch length buttons
- 19 «mem» (Memory / Operating buttons)
- 20 Alphabet / Motif scroll buttons
- 21 Balance / BSR button
- 22 Securing function button
- 23 Pattern begin button
- 24 Display
- 25 Needle position buttons
- 26 Needle stop up/down button
- 27 Mirror image button
- 28 Slide speed control
- 29 Start / Stop - button
- 30 Pattern end button
- 31 Quick reverse button
- 32 FHS (Free Hand System) connection

Back view

- 33 Horizontal spool pin
- 34 Carrying handle
- 35 Rear thread guideng
- 36 CFL sewing light
- 37 Slide-on table socket
- 38 Bobbin pre-tension

Side view (Head frame)

- 39 Tension adjustment wheel
- 40 Presser foot pressure
- 41 Presser foot lifter
- 42 Thread cutter on head frame
- 43 Magnifying glass holder

Side view (handwheel)

- 44 Handwheel
- 45 Spool pin (vertical, collapsible)
- 46 Power switch on/off («0»)
- 47 Power plug socket
- 48 PC connection
- 49 Embroidery module connection (optional accessory)
- 50 Foot control socket
- 51 Drop feed dog

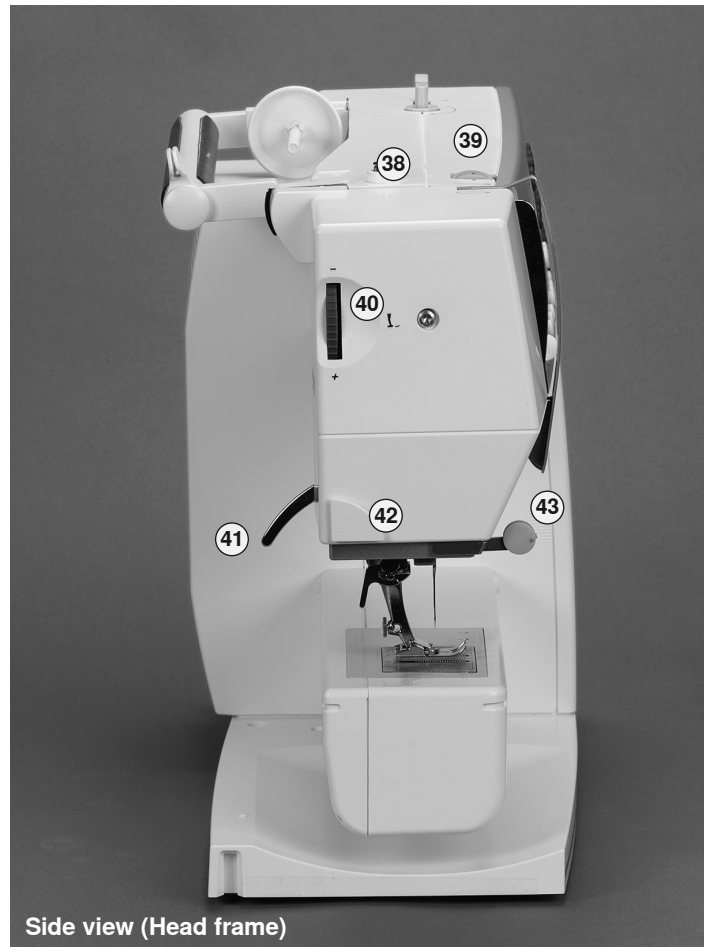

Side view (Head frame)

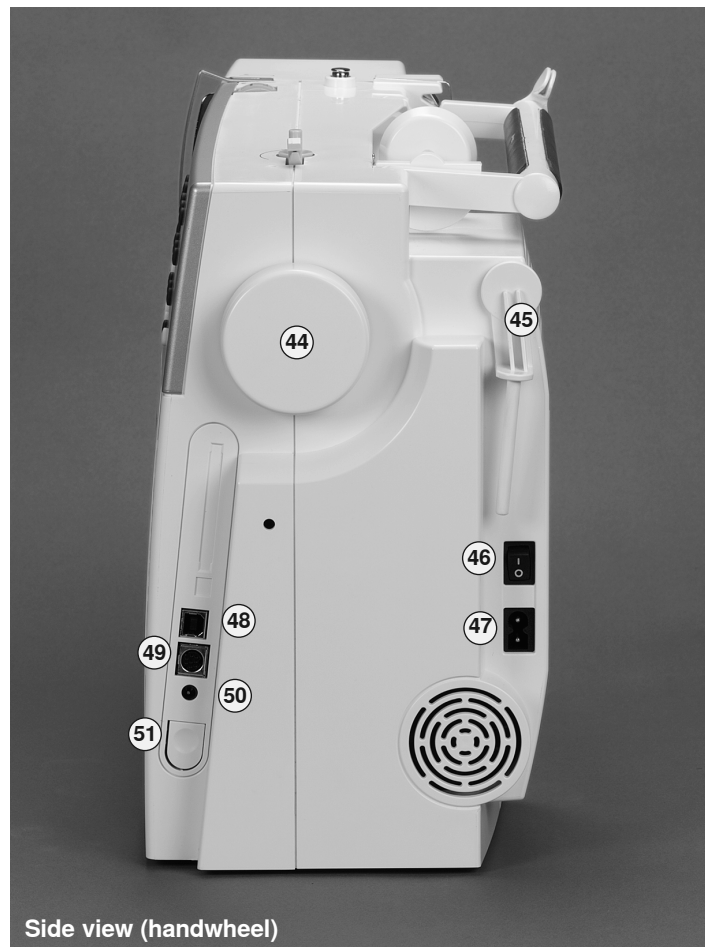

Side view (handwheel)

Power switch / Power cable

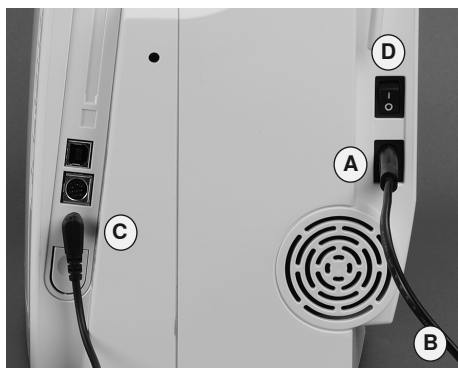

The power cable

- plug **A** into sewing computer
- plug **B** into wall socket

Foot control cable

- plug **C** into sewing computer

The power switch (D)

The switch is on the handwheel side

- I** the sewing computer is switched on («I»)
- 0** the sewing computer is switched off («0»)

The sewing light is switched on and off with the power switch.



Refer to the safety instructions



Important! (USA/Canada only)

This sewing computer has a polarized plug (one blade wider than the other). To reduce the risk of electrical shock, this plug is intended to fit in a polarized outlet only one way. If the plug does not fit fully in the outlet, reverse the plug. If it still does not fit, contact a qualified electrician to install the proper outlet. Do not modify the plug in any way!

Foot control

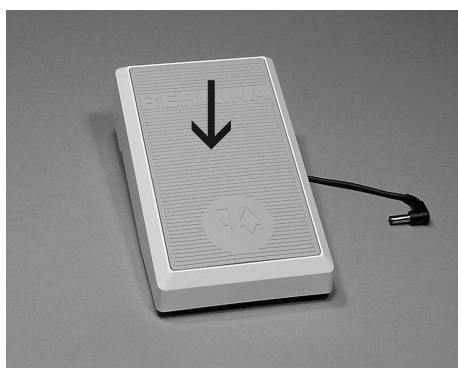

Sewing speed

- control the sewing speed by depressing the foot control
- raise or lower the needle by tapping on the foot control with your heel



Cable tidy

- wind the cable around the spool
- insert the plug into **A**

When sewing

- unwind the cable to the desired length and slip into **B** or **C**



Important! (USA/Canada only)

Use only foot controller type LV1 with sewing computer model aurora 430 / 440 QE / 450.

CFL Sewing Light



Contrary to an ordinary bulb, the CFL sewing light has a better illumination and a longer life.



Please note that a defective CFL sewing light must **ONLY** be replaced by an authorized technician. The sewing computer must be brought to an authorized BERNINA dealer!

Free Hand System (FHS) presser foot lifter



Your dealer can adjust the FHS if necessary.

Raising and lowering the presser foot

- knee-operated presser foot lever to raise and lower the presser foot - your hands remain free to guide the fabric
- with your knee push lever to the right
- the feed dog is lowered simultaneously
- the feed dog is raised as soon as the first stitch is sewn

Attaching the presser foot lifter

- insert the lever into respective opening - you should be able to operate the FHS with your knee in your normal sitting position

Slide-on table



Larger sewing surface

- the slide-on table increases the sewing surface

To attach

- raise needle and presser foot
- slide over free-arm to the right until it engages



Always raise needle and presser foot when attaching or removing the slide-on table!

To remove

- raise needle and presser foot
- use slight pressure - with your thumb against the housing and the index against the table - to slide it off to the left

Seam guide

- slide into extension table guides from left or right
- can be moved over full table length

Scale

- «0» corresponds to the center needle position

Threading the upper thread

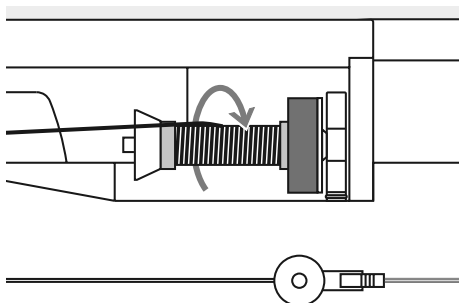
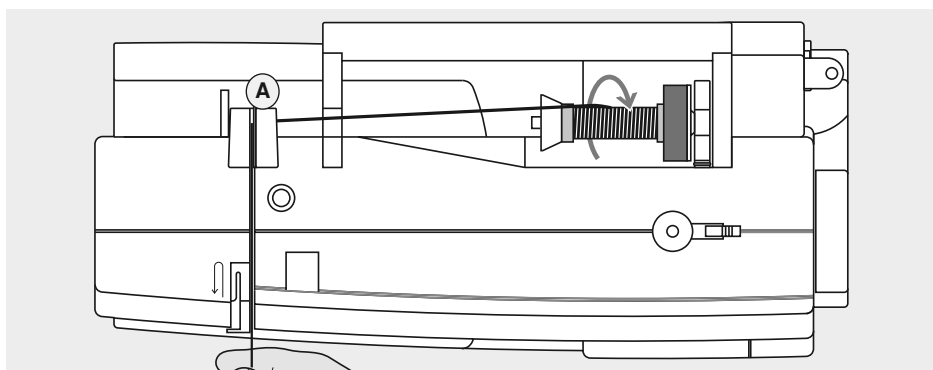

- attach the appropriate spool disc; diameter of spool determines disc size. There must be no clearance between the disc and the spool
- take thread through rear guide **A**
- then into slit of upper thread tension
- pull thread down to the right of the take-up cover to **B**
- take thread up to the left of the cover to **C** in the direction of the arrow, placing it in the take-up lever
- take thread down and through guides **D** and **E**

Attaching the thread spool

- raise the needle and presser foot
- turn the power switch to «0» (off)
- attach the foam pad
- place thread spool on spool holder in such way that the thread unwinds clockwise

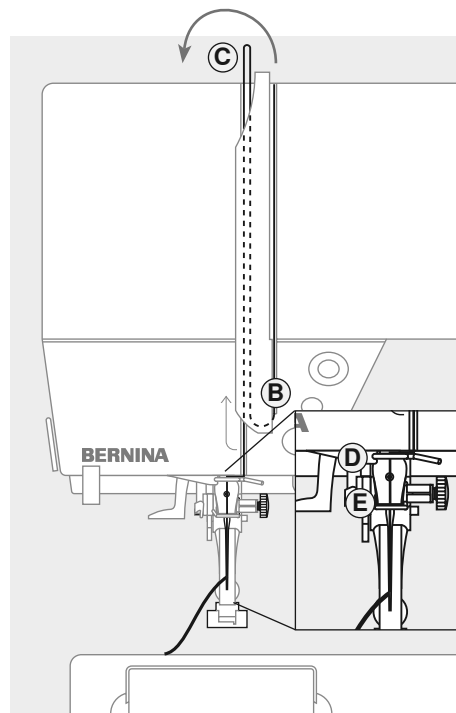

! Refer to the safety instructions!

Threading the Double Needle

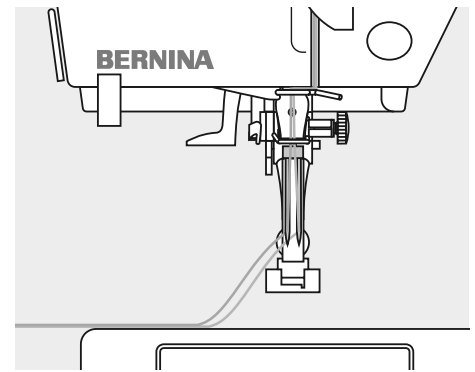
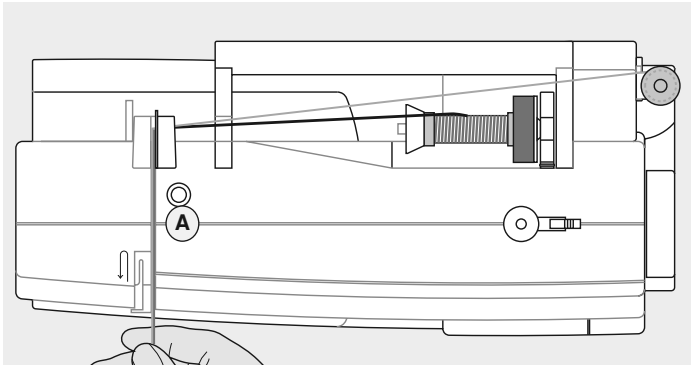

Threading the First Thread

- place thread spool on horizontal spool pin and thread
- guide the thread to the front in the slit and past the tension disc **A** on the right side
- thread sewing computer as usual and thread the right needle

Threading the Second Thread

- when using the supplementary spool pin (vertical) always attach the foam pad (prevents the thread from getting caught on the spool pin)
- place thread spool on the additional spool pin and thread
- guide the thread to the front in the slit and past the tension disc **A** on the left side
- thread the left needle
- threads must not be twisted together

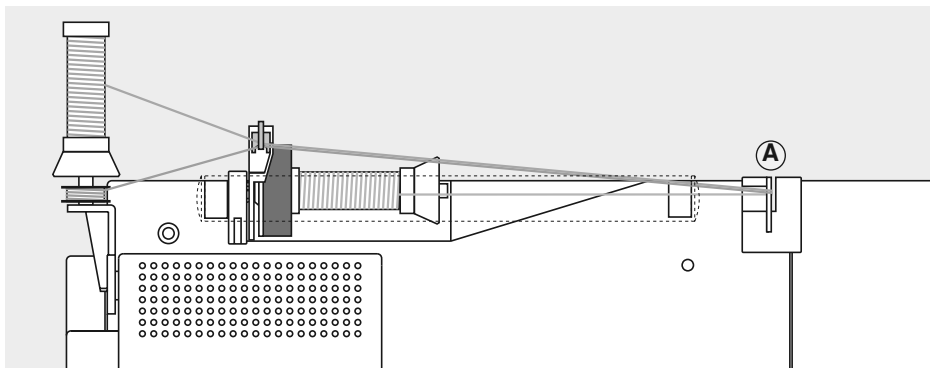

By using the Supplementary thread guide (special accessories), thread winds off the spool much easier.

Threading the Triple Needle

- two thread spools and one full bobbin are needed
- place one thread spool on horizontal spool pin
- place second thread spool and the bobbin, separated by a spool disc, on additional spool pin (both spools have to turn in the same direction)
- thread as usual by guiding two threads on the left side of the tension disc **A** and one thread on the right side of the disc

Needle threader

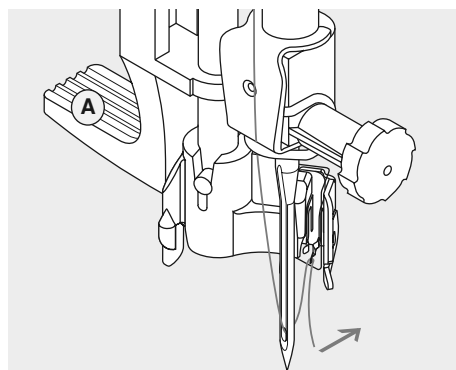
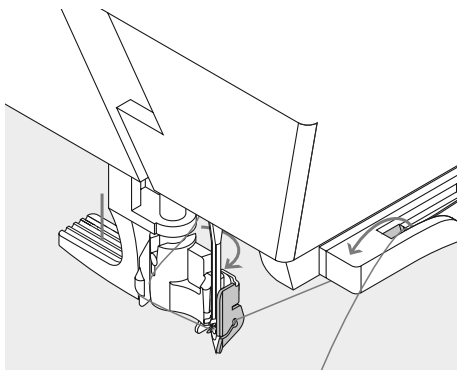
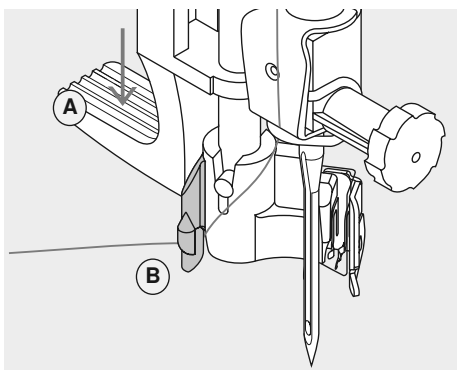

Press lever down

- Raise needle
- Lower presser foot
- Hold thread to the left and back
- Press down lever **A**, guiding the thread around hook **B** to the right, to the needle

Guide thread in front of the needle

- Pull thread from the front into the thread guide until it catches (wire hook) and pull from the back forwards over the thread cutter on the right side of the CFL sewing light
- The thread is cut and at the same time held in place

Release lever

- Release lever **A**
- Put the thread under the foot and pull the thread backwards or
- Put the thread under the foot, then pull it from front to back over the thread cutter on left side of the head frame



Double and triple needles must be threaded by hand.

Thread cutter

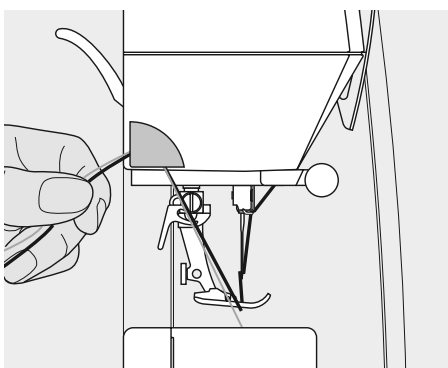

Thread cutter on head frame

- pull both threads from front to back over the cutter
- the threads release automatically as soon as the first stitch is sewn

Supplementary spool pin

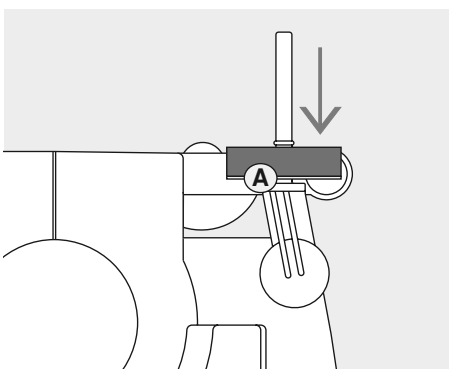
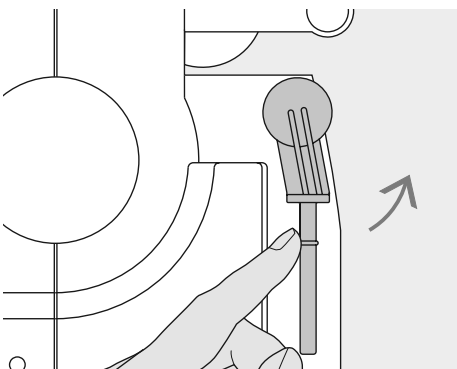

Collapsible vertical spool pin

- essential aid for sewing with more than one thread, i.e. double needle work
- turn pin up to stop when sewing

- we recommend to use foam pad **A** for better stabilizing of the spool and even unwinding of the thread

Winding the bobbin

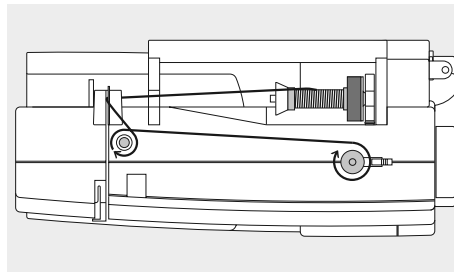
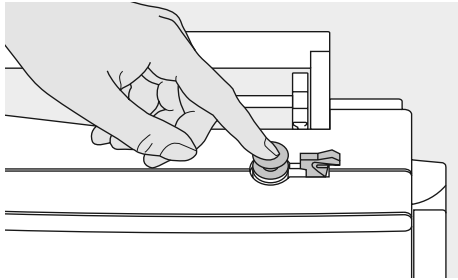

Winding the bobbin

- turn power switch to «I» (on)
- place empty bobbin on spindle

Threading the bobbin

- place thread on spool pin

- attach appropriate spool disc - diameter of thread spool determines disc size
- following the direction of the arrow, take thread through the rear guide and around the pre-tension stud

- wind the thread two to three times around the empty bobbin and cut off any excess thread on the thread cutter
- push engaging lever against bobbin, the winder works automatically
- the motor will stop automatically when the bobbin is full

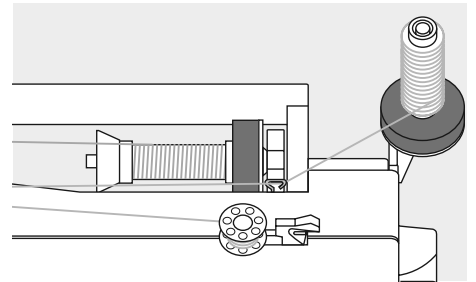
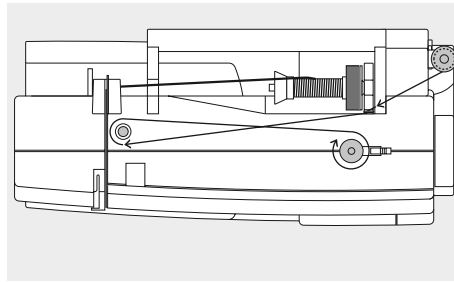
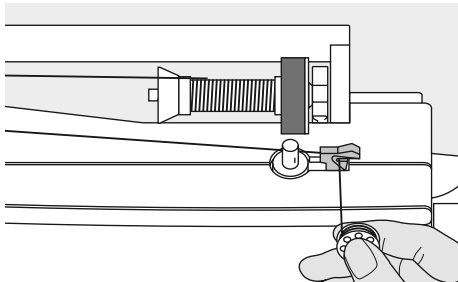

Thread cutter

- pull thread over thread cutter when removing the bobbin

Winding the bobbin while sewing or embroidering

- place thread spool on vertical spool then, following the direction of the arrow, take thread through the thread guide and around the pre-tension stud

- then proceed as mentioned above

Inserting the bobbin

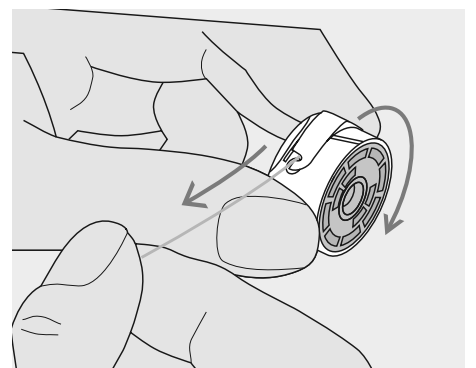
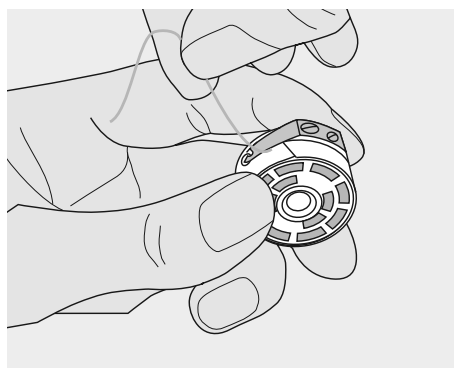
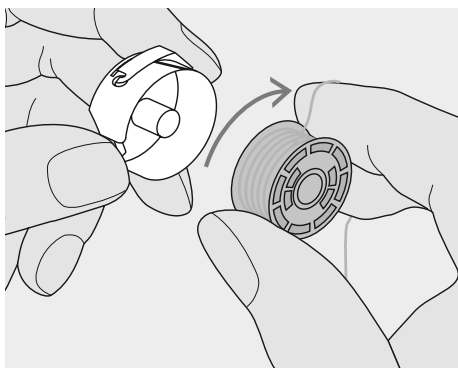

Inserting the bobbin

Insert the bobbin so that the thread winds clockwise.

Pulling the thread under the spring

Pull the thread into the slit, then to the left under the spring.

Clockwise turning of the bobbin

The bobbin must turn clockwise.



The bobbins are inserted and threaded in the same way in the aurora models 430, 440 QE and 450.

Bobbin case*

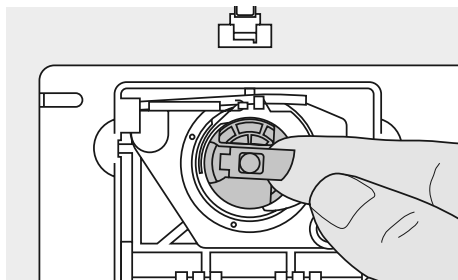

To remove the bobbin case

- raise the needle
- turn power switch to «0» (off)
- open the bobbin cover
- grasp the latch of the bobbin case
- remove case

* pictures = aurora 450

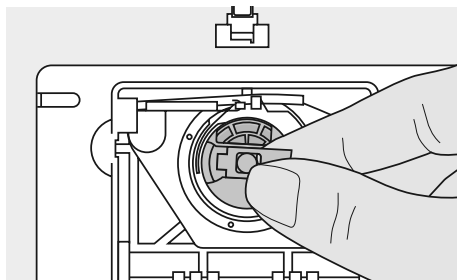

To insert the bobbin case

- hold the bobbin case latch
- **aurora 430 / 440 QE:** the finger on the case should point upwards
- **aurora 450:** bobbin case opening points up
- insert so that it clicks into place
- close the bobbin cover

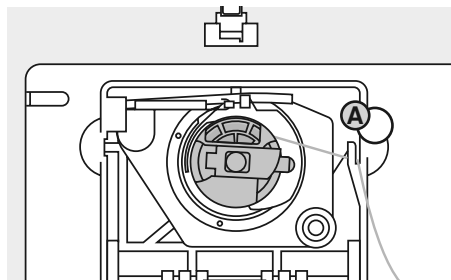

Bobbin thread cutter

- insert the bobbin case
- take the thread over cutter **A** and cut it
- the bobbin thread does not have to be brought up as the loose end is just the right length to start sewing

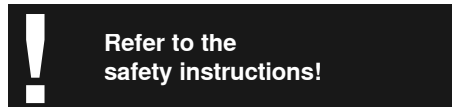

Refer to the safety instructions!

Changing the needle

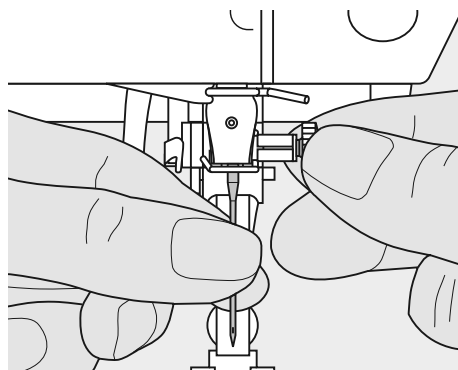

Removing the needle

- raise the needle
- turn power switch to «0» (off)
- lower the presser foot
- loosen the needle clamp screw
- pull the needle down to remove

Inserting the needle

- flat side of needle to the back
- insert the needle as far as it will go
- tighten the needle clamp screw

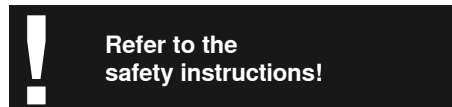

Refer to the safety instructions!

Changing the presser foot

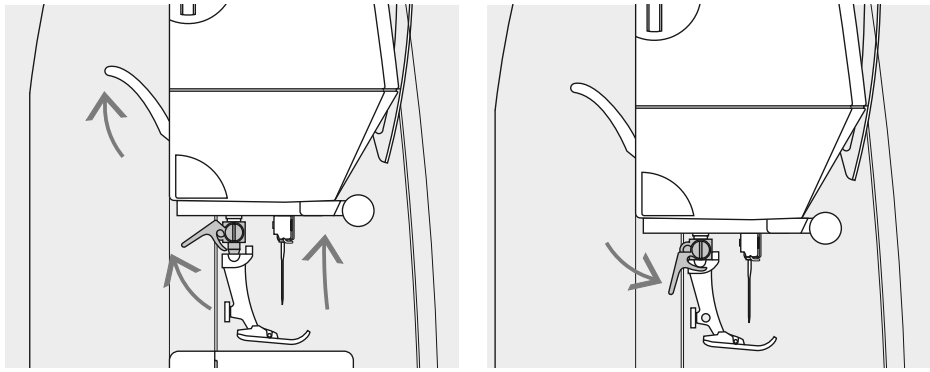

Changing the presser foot

- raise the needle and presser foot
- turn power switch to «0» (off)
- raise the clamping lever
- remove the presser foot

Attaching the presser foot

- guide the foot upwards over the cone
- press the clamping lever down

Thread tension

For example:

	Tension	Needle
Metallic thread	ca. 3	90
Monofilament	ca. 2-4	80



For special sewing work, the thread tension can be adjusted to suit the selected fabric and stitch pattern.

The basic setting

- is indicated when the red line on the tension adjustment wheel is in line with the marking **A**
- the tension does not need adjusting for normal sewing work

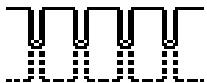

Thread tension settings

Perfect stitch formation

- the stitch formation is in the fabric

Upper thread tension too tight

- the lower thread is pulled more to the right side of the fabric
- to reduce the upper thread tension turn tension adjustment wheel to 3 - 1

Upper thread tension too loose

- the upper thread is pulled more to the wrong side of the fabric
- to increase the upper thread tension turn tension adjustment wheel to 5 - 10

Important facts about thread and needle

With the right combination of thread and needle optimum sewing results are achieved. The following are the guidelines: replace needle when starting a new sewing project.

Thread

The thread is chosen according to use. For a perfect sewing result, thread and material quality play an important role. It is recommended to use quality brand threads.

Cotton thread

- cotton threads are particularly suitable for cotton fabrics
- mercerized cotton threads have a slight sheen

Polyester thread

- polyester thread is suitable for practically all sewing needs
- it has a high tensile strength and is particularly colorfast
- polyester thread is more flexible and is recommended where a strong and elastic seam is required

Needle, thread and fabric

The correct needle size depends on the selected thread and fabric. Fabric type and structure determine which thread weight, needle size and needle tip should be used.

Needle summary

BERNINA requires needle system 130/705 H. This system number refers to shank shape as well as to length and form of the needle point.

Checking the needle condition

The needle condition should be checked and the needle replaced regularly. A defective needle not only damages the fabric but also the sewing computer.

Guidelines	Needle No.
fine fabrics: fine thread (darning thread, embroidery thread)	70–75
mediumweight fabrics: normal thread	80–90
heavyweight fabrics: heavier thread	100, 110, 120

130 / 705 H S 70

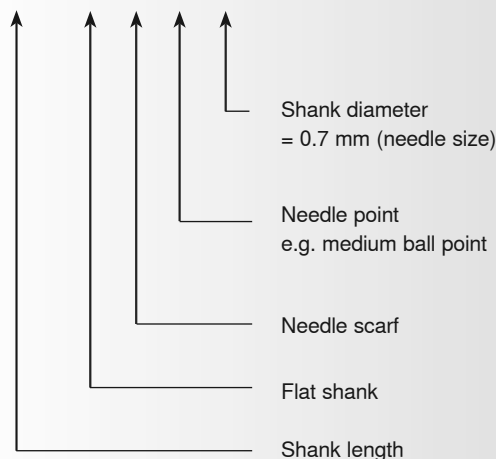

Needle/thread combination

In order to check the needle/thread compatibility, the correct size thread must correspond with the correct size needle.

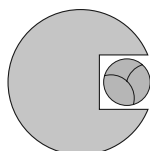

Correct needle/thread combination

When sewing, the thread should travel smoothly down the long groove on the front of the needle.

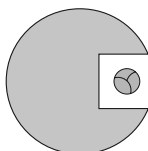

Too thin thread or too thick needle

The sewing thread has too much play in the groove. This could lead to skipped stitches and damage to the thread.

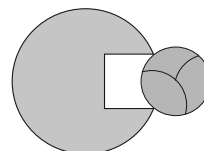







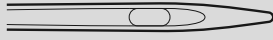

Too thick thread or too fine needle

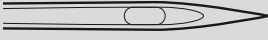
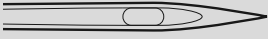
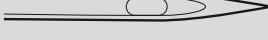
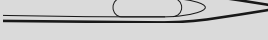
The thread rubs on the edges of the groove and can get jammed. This can break the thread.

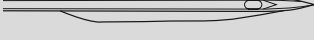
Needle summary

Many materials are easier to sew if the appropriate needle is used.

Type of needle	Model	Suitable for	Needle size
Universal 130/705 H	 Normal point, slightly rounded	For nearly all natural and synthetic fabrics (woven and knitted)	60–100
Jersey/Stretch 130/705 H-S 130/705 H-SES 130/705 H-SUK	 Ball point	Jersey, stretch fabrics	70–90
Leather 130/705 H-LL 130/705 H-LR	 Cutting point	Natural and synthetic leather and plastic	90–100
Jeans 130/705 H-J	 Very fine point	Heavyweight fabrics such as denim, canvas, overalls	80–110
Microtex 130/705 H-M	 Especially fine point	Micro fiber fabrics and silk	60–90
Quilting 130/705 H-Q	 Fine point	Straight and topstitching	75–90
Embroidery 130/705 H-E	 Large eye, slight ball point	Embroidery on all natural and synthetic fabrics	75–90
Metafil 130/705 H-MET	 Large eye	Sewing with metallic threads	75-90
Cordonnet/ Topstitching 130/705 H-N	 Small ball point, long eye	Topstitching with thick thread	80–100
Wing needle 130/705 HO	 Wide needle (wing)	Hemstitching	100–120
Double wing needle 130/705 H-ZWI-HO		Special effects with hemstitch embroidery	100
Double needle 130/705 H-ZWI	 Needle distances for 430 / 440 QE / 450: 1,0 / 1,6 / 2,0 / 2,5 / 3,0 / 4,0; plus 6,0 / 8,0 for 450	Visible hems in stretch fabrics, pintucks, decorative sewing	70–100
Triple needle 130/705 H-DRI	 Needle distance 3.0	Decorative sewing	80

Special needles are available at your **BERNINA** dealer.

Stitch plate

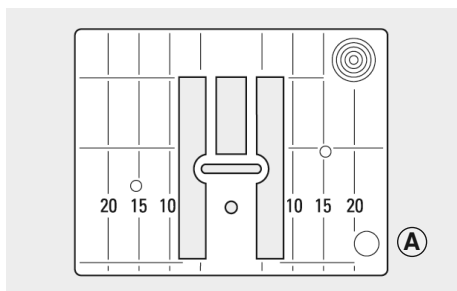

9mm (inch- or mm-measurements) just aurora 450

Stitch plate markings

- the stitch plates are marked with vertical lines in millimeters or inches
- mm measurements are at the front
- inch measurements are at the back
- the measurements correspond to the distance from the needle to the line

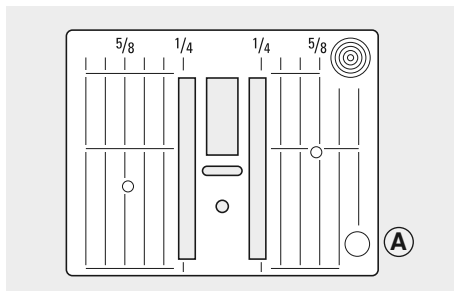

5,5mm (inch- or mm-measurements)

- needle insertion point is position 0 (center needle position)
- the mm/inch measurements are marked to the right and left
- the lines help to guide the fabric for sewing seams and for topstitching
- the horizontal markings are helpful for sewing corners and buttonholes, etc.

Removing the stitch plate

- turn power switch off («0»)
- raise the presser foot and needle
- lower the feed dog
- press the stitch plate down at the  back right corner until it flips up
- remove the stitch plate

Replacing the stitch plate

- place the stitch plate over the opening **A** and press down until it clicks into place

Feed dog

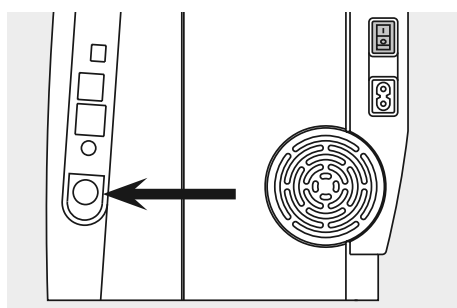

Button on handwheel side



Button flush with housing = Sewing position

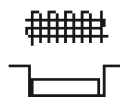

Button depressed = Darning position

- for freehand sewing, e.g. darning, freehand embroidery, freehand quilting
- for embroidery with the embroidery module

Feed dog and fabric feed



Let the fabric feed evenly.



Pulling, pushing or holding back the fabric will result in uneven stitches.

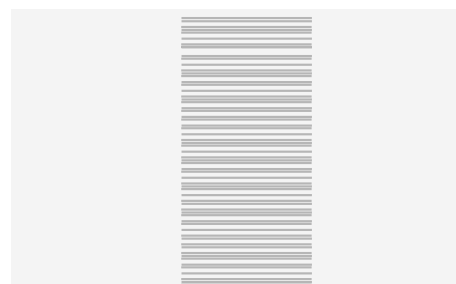

Feed dog and stitch length

With each stitch the feed dog moves forward by one step. The length of this step is determined by the stitch length selected.

With an extremely short stitch length, the steps are also very short. The fabric moves under the foot quite slowly, even at full sewing speed.

Buttonholes, satin stitch and decorative stitches are all sewn with a very short stitch length.

Feed dog and fabric feed with height compensating tool

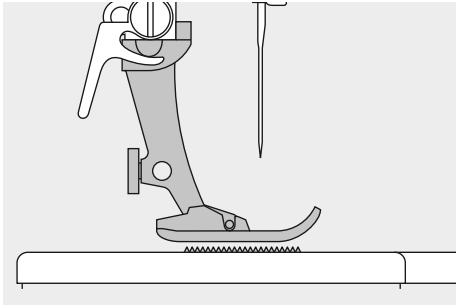

The feed dog works accurately when the foot is level.

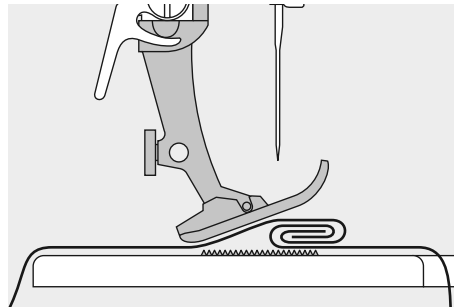

If the foot is at an angle, e.g. when sewing over thick to thin or vice-versa, the feed dog cannot grip and feed the fabric and the fabric might jam.

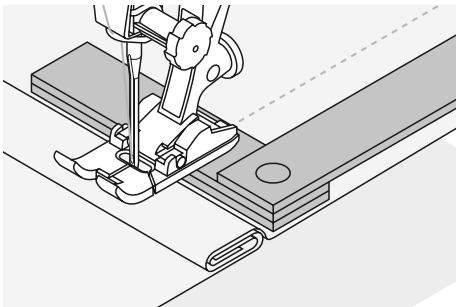

Uneven layers

To solve this problem, place one, two or three compensating plates as required **behind** the needle under the presser foot to level it.

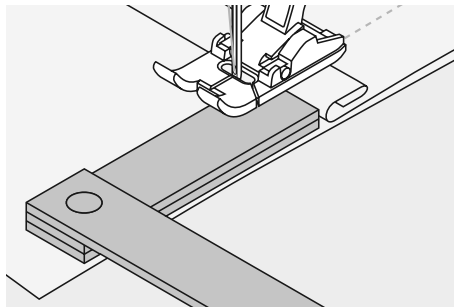

To correct the height **in front** of the foot, place one or more plates to the right of the foot close to the needle. Sew until the foot is level again and remove the plates.

Feed dog and sewing corners

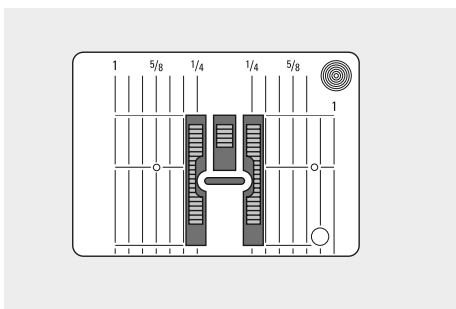

The space between the two rows of the feed dog is relatively large due to the width of the stitch plate hole.

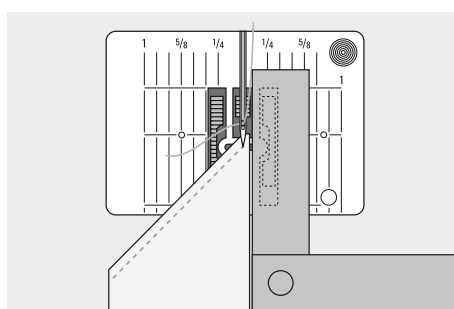

Place one or more plates as close as possible to the edge of the fabric on the right side of the presser foot. This allows for better feeding of the fabric when sewing corners.

Presser foot pressure

Dial on head frame

- the pressure is adjusted at the left side of the head frame

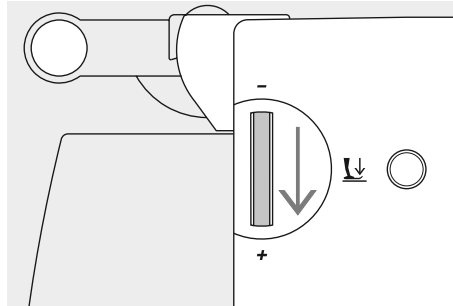

Increased pressure

- for firm fabrics
- improves fabric feed

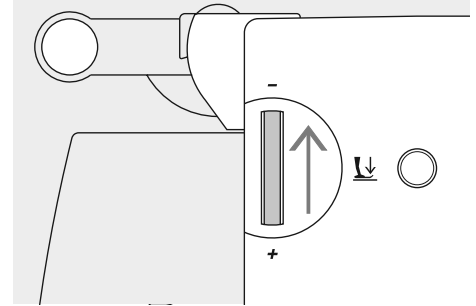

Reduced pressure

- for jerseys and loose knits
- to prevent fabric from stretching
- adjust pressure so that the fabric still feeds correctly



Standard pressure

- for normal sewing work
- default = 47
- the default setting is always visible, it blinks

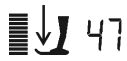

Balance

Different fabrics, threads, stabilizers and interfacings can affect programmed stitches so, that sometimes they might not join or might overlap, i.e. the stitches that make up the pattern are too close together or too far apart. These effects can be corrected with the Balance so that the stitch formation can be adjusted where necessary to suit the fabric.

 **Do not forget to reset the balance by pressing the balance or clr button after sewing with adjusted balance values.**

Balance for practical and decorative stitches

When sewing soft fabrics such as jersey or tricot, the fabric tends to stretch under the presser foot which also stretches the stitch being sewn. For example, the Honeycomb stitch opens up and is too long. Thicker fabrics might cause the stitch to overlap, making it too short. Correcting with the Balance is very easy. Test-sew first!

Stitch formation too long



Stitch formation too close



Desired stitch formation



- press the Balance button
- press the left Needle position button = shorter stitch length (maximum 9 steps)



- press the Balance button
- press the right Needle position button = longer stitch length (maximum 9 steps)

Display

aurora 430 / 440 QE

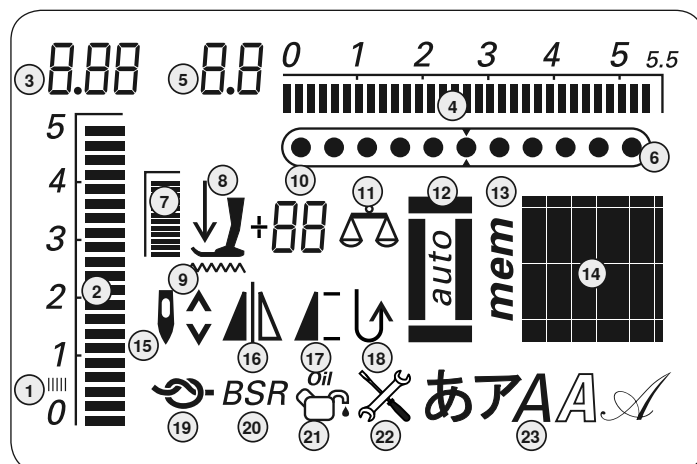

aurora 450

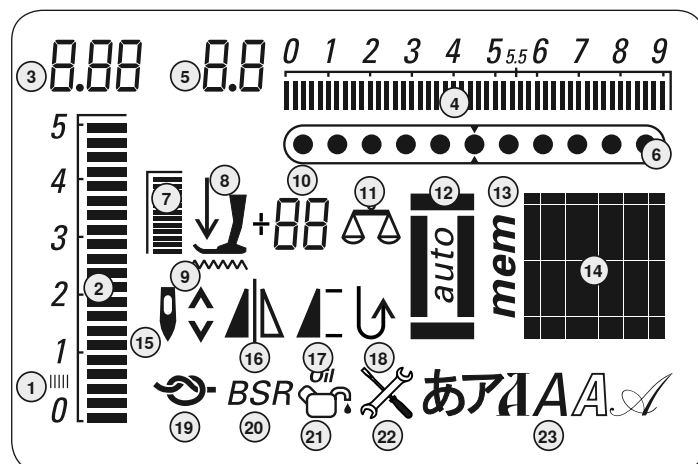

- | | | |
|--|---|--|
| <p>1 Satin stitch: dense, short zig-zag stitch</p> <p>2 Stitch length: basic setting blinks constantly</p> <p>3 Stitch length: actual value</p> <p>4 Stitch width: basic setting blinks constantly</p> <p>5 Stitch width: actual value</p> <p>6 Needle position: 11 positions</p> <p>7 Presser foot pressure: basic setting blinks</p> <p>8 Arrow and presser foot symbol: blink when presser foot is raised and the sewing computer is started</p> <p>9 Feed dog symbol: blinks when feed dog is not lowered in the BSR mode and embroidery mode</p> | <p>10 Triple digital display</p> <p>a. Presser foot indicator: displays matching foot for selected stitch</p> <p>b. Presser foot pressure: displays presserfoot pressure during adjusting</p> <p>c. Balance: displays the balance steps during balancing</p> <p>11 Balance: visible when the Balance button is pressed</p> <p>12 Buttonhole: visible when buttonhole is selected</p> <p>13 «mem»: visible when Memory is open</p> <p>14 Stitch: graphic or numeric</p> <p>15 Needle stop up / down: default stop up/ in BSR mode down</p> | <p>16 Mirror image: left / right</p> <p>17 Pattern begin/Pattern end</p> <p>18 Continuous reverse sewing</p> <p>19 Securing function</p> <p>20 BSR: Bernina Stitch Regulator</p> <p>21 Cleaning notification: visible when the sewing computer must be cleaned/oiled</p> <p>22 Service notification: visible when the sewing computer must be taken for a service to the BERNINA dealer</p> <p>23 Alphabet</p> |
|--|---|--|

Function buttons



Stitch width

- left button = narrows the stitch width
- right button = widens the stitch width
- keep button pressed = quick steps
- the basic setting of the selected stitch blinks constantly



Stitch length

- left button = shortens the length
- right button = elongates the length
- keep button pressed = quick steps
- the basic setting of the selected stitch blinks constantly



Needle position

- left button = needle to the left
- right button = needle to the right
- keep button pressed = quick steps
- total of 11 needle positions: 5 left, 5 right and 1 center



Pattern begin

- press the button
- the needle moves to the beginning of a stitch or stitch program



Mirror image (left/right)

- press the button
- mirror image of selected stitch will be sewn



«clr» (clear)

- press the button
- stitch length, stitch width, needle positions are returned to basic settings
- active functions are deleted

Exception:

needle stop down



Securing function (with 4 stitches)

- press the button before starting to sew = individual stitches or stitch combination will be secured at the beginning
- press the button during an individual stitch = the stitch will be secured at the end
- the sewing computer stops
- press the button during stitching a stitch combination = the stitch combination will be secured at the end
- the sewing computer stops



Needle up/down

In the basic setting the arrow points up.

- press the button briefly:
 - the needle will go up or down (same as tapping on the foot control)
- press the button longer:
 - the needle will go down
 - the arrow on the display points down
 - the sewing computer stops with the needle down
- press the button longer again:
 - the needle will go up
 - the arrow on the display points up
 - the sewing computer stops with the needle up



Balance / BSR

Balance

- press the button
- the balance symbol on the display is active
- press the left arrow of the needle position = subtracts space between stitches
- press the right arrow of the needle position = adds space between stitches
- press the button again = the balance is turned off, the altered stitch returns to the basic settings
- altered needle position settings remain during the balance process

BSR

- with the attached BSR foot the BSR function is switched on and off by pressing the button

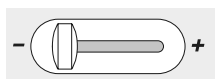

Slide speed control

- the motor speed can be freely adjusted from minimum to maximum with the slide control
- when winding the bobbin thread the speed of the winder can be regulated, when the sewing computer is not sewing



mem (Memory)

- press the *mem* button
- «mem» will appear on the display
- the empty memory spaces (90) or (60) and the cursor blink
- use the left arrow and the *mem* button to scroll and program stitches, letters and numbers



Reverse sewing

quick reverse:

- press the button
- sews in reverse until the button is released
- programs buttonholes
- programs darning length
- seam end in securing program no. 5
- manual securing at beginning and end of seam

continuous reverse:

- press button until a beep is heard before sewing and the symbol is visible on the display
- the sewing computer sews the chosen stitch in reverse
- to cancel: press button until a beep is heard before sewing and the symbol goes off



Pattern end / Pattern repeat

press the button while sewing

- the sewing computer stops at the end of the active single stitch or the active stitch in a stitch combination (in Memory)

press and release button before sewing

- the Pattern end symbol appears on the display
- a single stitch or the first stitch of a stitch combination in the Memory will be sewn 1x, the sewing computer will stop
- when continuing to sew the Pattern end function is turned off again and the Pattern end symbol disappears

press button until a beep is heard before sewing

- the Pattern end symbol appears on the display
- a stitch or stitch combination in the Memory will be sewn 1x
- the Pattern end function is active as long as the button is pressed again until a beep is heard before sewing
- the Pattern end symbol on the display disappears



Start-Stop button

- starts and stops the sewing computer when operating it **without** foot control
- starts and stops the sewing / embroidery computer in the embroidery mode with attached embroidery module
- starts and stops the BSR function when BSR foot is attached and plugged in; **without** foot control

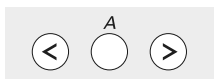

Stitches

- in single mode, press the arrow buttons to scroll through all stitch patterns

Alphabets, numbers

- press the center-button
- one of the existing fonts will appear on the display
- press the Alphabet button to select the font
- press the right button to scroll letters, numbers and special characters forwards (A B C...)
- press the left button to scroll special characters backwards () [] ...)



#-button

Standard = graphic display

- press button and enter desired stitch number
- the stitch will be displayed graphically (image)

Alternative = numeric display

- press button until a short beep is heard
- the display of the active stitch will change from graphic (image) to numeric (number)
- further stitches will now be displayed numerically (number)

switch again to standard display in the same manner

Entering 3 digit stitch numbers:

- press button until the number «1» appears
- now enter the other two numbers

Letters/numbers/special characters

A B C D E F G H I J K L M N
 O P Q R S T U V W X Y Z Ä Ö Ü
 Å Æ Ç Ø Ñ Ê Ë Ä Å
 1 2 3 4 5 6 7 8 9 0
 _ . ' ! + = & ÷ ? % ç @ () []

Memory

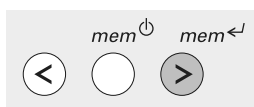

Memory buttons

- use the left button to scroll the contents backwards
- use the center button to open and close the Memory
- use the *mem*←-button to save and forward scroll

Any combination of 90 (aurora 440 QE) or 60 (aurora 430 / 450) stitches, letters or numbers can be saved in Memory, which is long term-memory. They remain saved until deleted by the user. Power failures or disconnection from the electricity supply do

not affect the Memory. Alterations to the stitch length, width or needle position can be made at any time. Individual stitches, letters or numbers can be deleted or overwritten.

Programming practical and decorative stitches

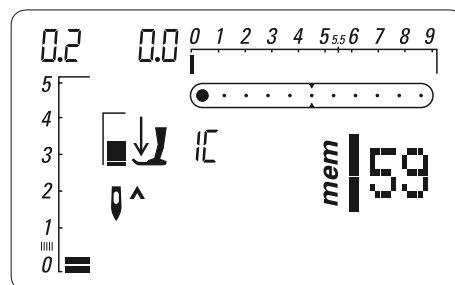
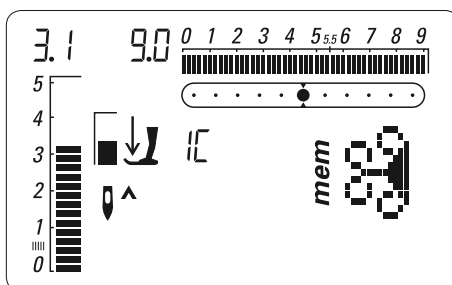
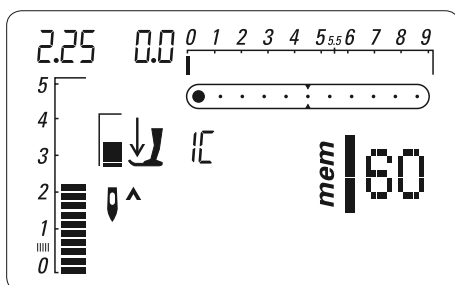

Open Memory

- press the *mem*⏏-button
- the cursor on the left and the available number of empty memory spaces (e.g. 60) start to blink, and «mem» appears
- select desired stitch
- stitch image appears on the display
- press the *mem*←-button
- the stitch is programmed
- the number of available Memory spaces appears
- select the next stitch
- press the *mem*←-button to save, continue in the same manner



These stitch patterns and programs can not be programmed:

Buttonholes / securing stitch No. 5, No. 61 (450)
 Eyelets No. 20, 21 (450), No. 18, 19 (440), No. 17 (430)
 Button sew-on program No. 19 (450), No. 17 (440), No. 16 (430)
 Darning program No. 22 (450), No. 20 (440), No. 18 (430)
 Large fly stitch No. 23 (450)
 Basting stitch No. 24 (450), No. 21 (440), No. 19 (430)



Sew begin

When the foot control or the Start - Stop - button is pressed, the sewing computer automatically starts sewing the stitch combination from the beginning.

aurora 430 / 440 QE

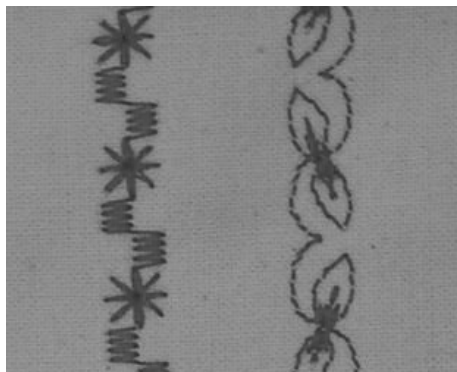

A

B

**Example A:
Sewing a stitch combination continuously**

- press the *mem*[Ⓞ]-button
- select stitch, e.g. No. 155 (440) or 126 (430)
- press the *mem*[↵]-button, select new stitch, e.g. stitch No. 92 (440) or 69 (430), press the *mem*[↵]-button, etc.
- sew the stitch combination
- press the *mem*[Ⓞ]-button = the stitch combination will be saved
- during the process of saving an hourglass is visible on the display

aurora 450

**Example A:
Sewing a stitch combination continuously**

- press the *mem*[Ⓞ]-button
- select stitch, e.g. No. 143
- press the *mem*[↵]-button, select new stitch, e.g. stitch No. 95, press the *mem*[↵]-button, etc.
- sew the stitch combination
- press the *mem*[Ⓞ]-button = the stitch combination will be saved
- during the process of saving an hourglass is visible on the display

**Example B:
Combining stitch and function (Mirror image) and sewing continuously**

- program desired stitch, e.g. No. 159 (440) or 130 (430)
- activate Mirror image, program mirrored stitch No. 159 (440) or 130 (430)



- sew stitch combination, the stitches alternate (original and mirror image)

**Example B:
Combining stitch and function (Mirror image) and sewing continuously**

- program desired stitch, e.g. No. 152
- activate Mirror image, program mirrored stitch No. 152



- sew stitch combination, the stitches alternate (original and mirror image)



Decorative stitch combinations with embroidery thread

- gives stitches a fuller appearance

Stitch combinations on double fabric

- bottom layer does not pucker

Stitch combinations on single fabric

- always use an appropriate stabilizer as a backing
- remove after sewing
- thread the lower thread in the finger of the bobbin case for best results (430 / 440 QE)

Programming alphabets and numbers

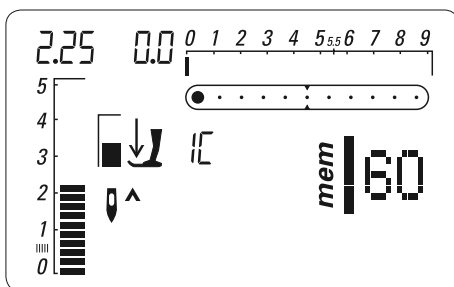

Open Memory

- press the *mem* ϕ -button
- the cursor on the left and the available number of empty memory spaces (e.g. 60) start to blink, and «mem» appears

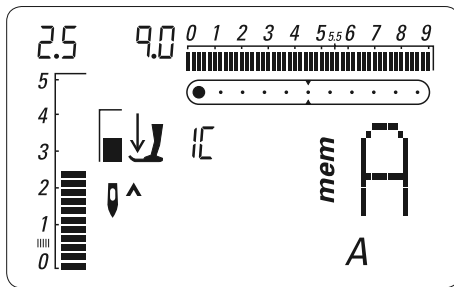

Select alphabet

- press the Alphabet button to select the alphabet of your choice
- the letter A in the alphabet of your choice appears on the display

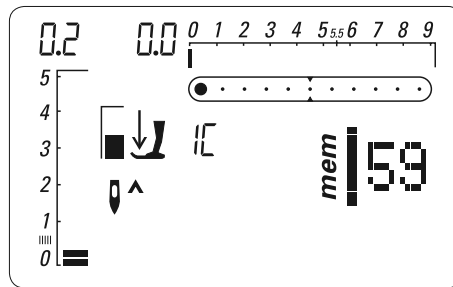

Programming letters/numbers

- select letter/number
- press *mem* \leftarrow (save) button = letter/number is programmed
- the number of empty Memory spaces is indicated
- select the next letter/number
- program, using *mem* \leftarrow etc.
- programming several words
- to insert a space, select (_)
- program, using *mem* \leftarrow
- program the next word
- if adjustments are made to the stitch length or width, all programmed letters and/or numbers will be affected
- if only single letters or numbers are to be altered, each letter must be altered individually

Example: Programming letters and numbers

- open Memory, select font
- enter letters and/or numbers
- the entered letter or number appears on the display
- activate the Securing function \rightarrow
- the sewing computer secures at the beginning of the entered combination
- to save the combination press the *mem* ϕ -button
- during the process of saving an hourglass is visible on the display
- trim connecting threads

Block capitals	A
Double block capitals	A
Script (Italics)	A
Kyrillic capitals (450)	A

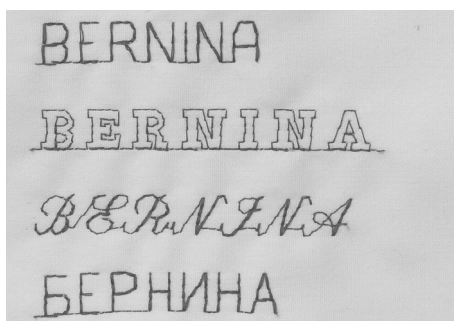

Corrections in Memory

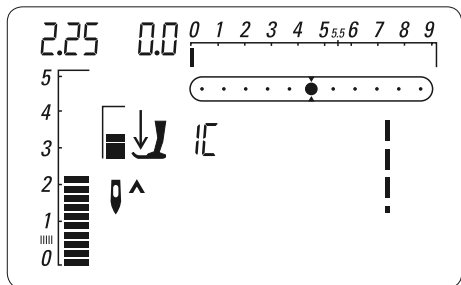

The contents of the Memory remain saved even when the sewing computer is disconnected from the electrical supply. They can be recalled at any time.

The contents of the Memory will be lost if the sewing computer is switched off without pressing the *mem*[⏏]-button before closing the Memory, as they were not saved.

Balance in Memory

- the contents of the Memory as a whole can be balanced as follows:
 - close Memory *mem*[⏏]
 - touch the Balance button 
 - open Memory, now balance *mem*[⏏] the entire contents of the Memory with both needle position buttons

Overwriting individual stitches, letters or numbers

- press the *mem*[⏏] or left button and scroll to the stitch you wish to overwrite

- select new stitch number / letter / number, new stitch length/width or needle position
- press *mem*[⏏]-button (to save)
- the original stitch is corrected (overwritten)

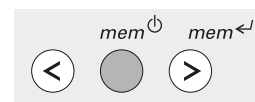
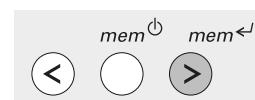
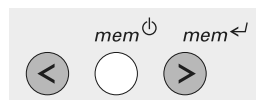

Deleting individual stitches, letters or numbers

- press the *mem*[↵]-button or left button and scroll until the stitch you wish to delete appears on the display
- press the «clr»-button
- the desired stitch/letter/number is deleted

Delete complete Memory contents

- press the «clr»-button, keep depressed and press the *mem*[⏏]
- release both buttons
- leave Memory by pressing *mem*[⏏] again

Leaving Memory

- press the *mem*[⏏]-button
- during the process of saving an hourglass is visible on the display
- all entries are saved
- Memory closes
- the word «mem» disappears from the display

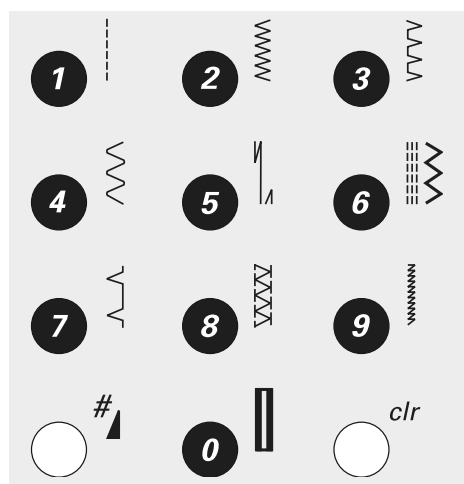

Stitch selection

- stitches 1–10:** press the appropriate button; stitch graphic and basic width and length settings appear on the display
- stitches 11–99:** press the #-button and the appropriate number
- stitches from 100: press the #-button longer until a «1» appears in display, then enter the last two digits of the stitch

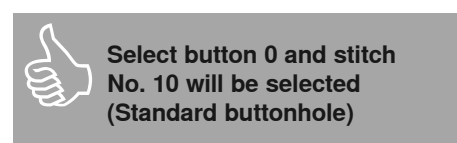

Stitch selection

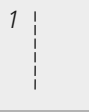

Straight stitch
All non-stretch fabrics. All straight stitch work



Zig-zag
Most fabric types. All simple zig-zag such as clean finishing fine fabrics. Sewing on elastic and lace



Vari-overlock
Primarily for fine jerseys, stretch overlock seams and hems



Running stitch
Most types of fabric. Mending, patching, reinforcing seams, etc.



Securing stitch
All types of fabric. Secures the beginning and end of seams sewn with straight stitch



Triple straight and triple zig-zag
Reinforced seams in tough, heavy fabrics, topstitching



Blindstitch
Most types of fabric. Blind hems, scallop edging effect on soft jerseys and fine fabrics, decorative seams



Double overlock
All types of knit. Overlock = sew and neaten in one operation, decorative seams

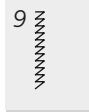

Super stretch
Open seam for all super-stretch fabrics



Standard buttonhole
Fine to mediumweight fabrics. Blouses, shirts, trousers, bedlinens, etc.



Narrow buttonhole
Light- to mediumweight fabrics. Blouses, dresses, trousers, children's and baby clothes, crafts



Stretch buttonhole
All stretch fabrics made from cotton, wool, silk and synthetic fibers

aurora 430



Keyhole buttonhole
Heavyweight, non-stretch fabrics. Jackets, coats, trousers, leisure wear



Darning program
Automatic darning for fine and mediumweight fabrics

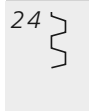

Universal stitch
Firm fabrics such as felt and leather. Flat joining seams, visible seams, sewing on elastic, decorative seams



Straight stitch buttonhole
For reinforcing buttonholes, pocket edges, especially for stitching buttonholes in leather or imitation leather

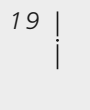

Basting stitch
Basting seams, hems, quilts, etc.

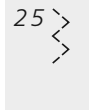

Sewn-out zig-zag
Clean finishing woven fabrics, reinforcing edges, attaching elastic, decorative seaming



Hand-look buttonhole
Light- to mediumweight woven fabrics. Blouses, dresses, leisure wear, bedding



Reinforced overlock
Medium-to heavyweight knits and toweling, overlock seams, flat joining seams

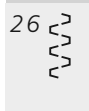

Lycra stitch
All two-way stretch fabrics, flat joining seams and hems, reinforced seaming on underwear



Button sew-on program
For buttons with 2 and 4 holes



Jersey stitch
Natural, blended or synthetic fabrics and delicate knits. Visible seams and hems. Mending jersey/interlock

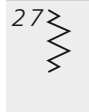

Stretch stitch
All stretch fabrics, open seam in sportswear



Straight stitch eyelet
Opening for cords and narrow ribbons, decorative work



Honeycomb stitch
Most types of interlock and woven fabrics. Visible seams and hems, etc.



Knit overlock
All knits, machine or handmade, overlock seam. Sews and finishes edges in one operation

aurora 440 QE

13

**Round buttonhole**

For medium- to heavyweight fabrics of all types. Clothing, jackets, coats, rainwear

14

**Keyhole buttonhole**

Heavyweight, non-stretch fabrics. Jackets, coats, trousers, leisure wear

15

**Straight stitch buttonhole**

For reinforcing buttonholes, pocket edges, especially for stitching buttonholes in leather or imitation leather

16

**Hand-look buttonhole**

Light- to mediumweight woven fabrics. Blouses, dresses, leisure wear, bedding

17

**Button sew-on program**

For buttons with 2 and 4 holes

18

**Narrow zig-zag eyelet**

Opening for cords and narrow ribbons, decorative work

19

**Straight stitch eyelet**

Opening for cords and narrow ribbons, decorative work

20

**Darning program**

Automatic darning for fine and mediumweight fabrics

21

**Basting stitch**

Basting seams, hems, quilts, etc.

22

**Gathering stitch**

Most types of fabric. Gathering with shirring elastic. Butted seams = butting two pressed edges and sewing together

23

**Stretch overlock**

Mediumweight knits, toweling and firm wovens. Overlock seams, flat joining seams

24

**Jersey stitch**

Natural, blended or synthetic fabrics and delicate knits. Visible seams and hems. Mending jersey/interlock

25

**Honeycomb stitch**

Most types of interlock and woven fabrics. Visible seams and hems, etc.

26

**Universal stitch**

Firm fabrics such as felt and leather. Flat joining seams, visible seams, sewing on elastic, decorative seams

27

**Sewn-out zig-zag**

Clean finishing woven fabrics, reinforcing edges, attaching elastic, decorative seaming

28

**Lycra stitch**

All two-way stretch fabrics, flat joining seams and hems, reinforced seaming on underwear

29

**Stretch stitch**

All stretch fabrics, open seam in sportswear

30

**Reinforced overlock**







Medium-to heavyweight knits and toweling, overlock seams, flat joining seams







31







**Knit overlock**

All knits, machine or handmade, overlock seam. Sews and finishes edges in one operation

aurora 450

- 13  **Round buttonhole**
For medium- to heavyweight fabrics of all types. Clothing, jackets, coats, rainwear
- 14  **Round buttonhole with a square end**
For medium- to heavy-weight fabrics: clothing, jackets, coats, rain clothing
- 15  **Keyhole buttonhole**
Heavyweight, non-stretch fabrics. Jackets, coats, trousers, leisure wear
- 16  **Keyhole buttonhole with a tapered end**
For firm, non-stretchable fabrics: jackets, coats, leisure-wear
- 17  **Hand-look buttonhole**
Light- to mediumweight woven fabrics. Blouses, dresses, leisure wear, bedding
- 18  **Straight stitch buttonhole**
For reinforcing buttonholes, pocket edges, especially for stitching buttonholes in leather or imitation leather
- 19  **Button sew-on program**
For buttons with 2 and 4 holes

- 20  **Narrow zig-zag eyelet**
Opening for cords and narrow ribbons, decorative work
- 21  **Straight stitch eyelet**
Opening for cords and narrow ribbons, decorative work
- 22  **Darning program**
Automatic darning for fine and mediumweight fabrics
- 23  **Large fly stitch**
For medium- to heavy-weight fabrics. To reinforce pocket openings, zippers and plackets
- 24  **Basting stitch**
Basting seams, hems, quilts, etc
- 25  **Gathering stitch**
Most types of fabric. Gathering with shirring elastic. Butted seams = butting two pressed edges and sewing together
- 26  **Stretch overlock**
Mediumweight knits, toweling and firm wovens. Overlock seams, flat joining seams

- 27  **Jersey stitch**
Natural, blended or synthetic fabrics and delicate knits. Visible seams and hems. Mending jersey/interlock
- 28  **Honeycomb stitch**
Most types of interlock and woven fabrics. Visible seams and hems, etc.
- 29  **Universal stitch**
Firm fabrics such as felt and leather. Flat joining seams, visible seams, sewing on elastic, decorative seams
- 30  **Sewn-out zig-zag**
Clean finishing woven fabrics, reinforcing edges, attaching elastic, decorative seaming
- 31  **Lycra stitch**
All two-way stretch fabrics, flat joining seams and hems, reinforced seaming on underwear
- 32  **Stretch stitch**
All stretch fabrics, open seam in sportswear
- 33  **Reinforced overlock**
Medium-to heavyweight knits and toweling, overlock seams, flat joining seams

Temporary altered stitch Memory

Temporary altered stitch Memory

- for all types of stitches and materials
- altered stitch length, stitch width and needle position will be saved automatically
- sewing of an altered stitch (e.g. zig-zag)
- selecting and sewing another stitch (e.g. straight stitch)
- when returning to the individually altered zig-zag the alterations will remain
- the Altered stitch Memory can contain as many stitches as needed

Reset to basic settings

- individual stitches can be reverted to basic settings manually
- press the «clr» button
- when turning the sewing computer off all altered stitch settings in the Altered stitch Memory will be deleted

Application:

- especially valuable when using two alternating applications such as finishing edges, zig-zag, adjusting vari-overlock to suit the material
- straight stitch seam: use altered stitch length
- blindstitch: altering stitch width and stitch length to suit material



The temporary altered stitch memory can hold as many stitch alterations as needed (these are stitch length, stitch width, needle position, mirror image and balance).

Straight Stitch



Stitch: **Straight stitch No. 1**
 Needle: **size and type suitable for the fabric selected**
 Thread: **cotton or polyester**
 Feed dog: **up**
 Presser foot: **430 / 440 QE: Reverse pattern foot No. 1**
450: Reverse pattern foot No. 1C

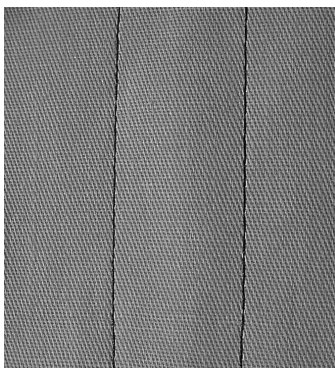

Straight Stitch

- after turning the sewing computer on, the Practical Stitch appears

Application

- suitable presser foot to be selected according to the technique, e.g. manual darning
- suitable for all fabrics



Adjust the stitch length to suit the fabric

For example use a longer stitch length (approximately 3 - 4mm) with denim, a shorter length (2 - 2.5mm) with batiste.

Adjust the stitch length to suit the thread

For example use a longer stitch length (approximately 3 - 5mm) when sewing with cordonnet thread for topstitching.

Activate needle stop down

Prevents the fabric from slipping when you stop to adjust stitch or pivot.

Triple Straight Stitch Seam



Stitch: **Triple straight stitch No. 6**
 Needle: **Jeans or 80-90 universal**
 Thread: **cotton or polyester**
 Feed dog: **up**
 Presser foot: **430 / 440 QE: Reverse pattern foot No. 1**
450: Reverse pattern foot No. 1C,
Jeans foot No. 8 (optional accessory)



Open Seam

- durable seam for firm and densely woven fabrics such as denim and corduroy
- reinforced seam subject to hard wear



For heavy layers or very densely woven fabrics:

A Jeans needle or Jeans foot No. 8 will help when sewing very heavy fabrics, such as denim or canvas.

Decorative top stitch

Lengthen out stitch and use as a decorative top stitch with denim.

Edge stitching



Stitch: **Straight stitch No. 1**
 Needle: **size and type suitable for the fabric selected**
 Thread: **cotton, polyester or cordonnet (topstitching)**
 Feed dog: **up**
 Presser foot: **Blindstitch foot No. 5**
430 / 440 QE: Reverse pattern foot No. 1
450: Reverse pattern foot No. 1C
Edge stitch foot No. 10 (optional accessory)

Narrow edgestitching

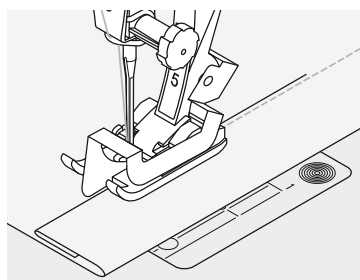
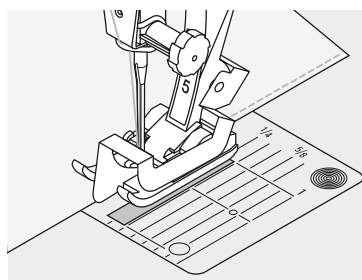

Foot No. 5:
use any left or far right
needle position
Foot No. 10:
all needle position

Outer edges

- place edge of fold against the guide on the Blindstitch foot
- select needle position at desired distance from the folded edge

Hem edges

- place edge of fold against the guide on the Blindstitch foot (inside upper edge of hem)
- select needle position right to sew along the upper edge

Needle position

- left for outer edge
- right for inner edge (hem edges)

Presser foot

- Blindstitch foot No. 5

Wide edgestitching

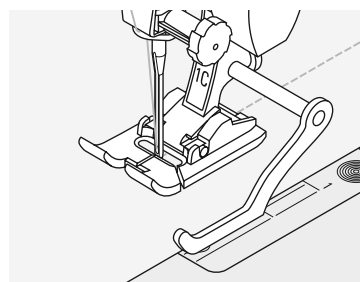
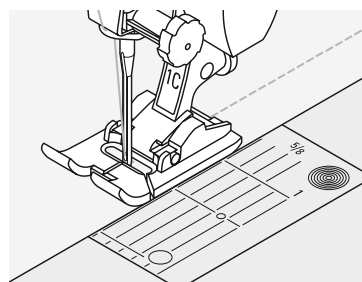

Edgestitching with seam guide
 • a big help when sewing parallel lines, grids, etc.

Guiding the fabric

Presser foot as a guide:

- guide the folded edge along the edge of the presser foot

Stitch plate as a guide:

- guide the folded edge along the marks on the stitch plate (for stitching 3/8" to 1 1/8" (1 to 2.5cm) from the edge)

Seam guide as a guiding aid:

- insert the seam guide into the hole on the back of the presser foot shaft
- adjust as desired
- tighten the screw
- guide the folded edge along the seam guide
- to sew parallel lines, guide the seam guide along a previously sewn line of stitches

Needle position

- adjust the needle position to select desired distance between rows of topstitching or from fabric edge

Presser foot

- **430 / 440 QE:** Reverse pattern foot No. 1
- **450:** Reverse pattern foot No. 1C

Securing stitch (straight stitch)



Stitch: **Securing stitch No. 5**
 Needle: **size and type suitable for the fabric selected**
 Thread: **cotton or polyester**
 Feed dog: **up**
 Presser foot: **430 / 440 QE: Reverse pattern foot No. 1**
450: Reverse pattern foot No. 1C

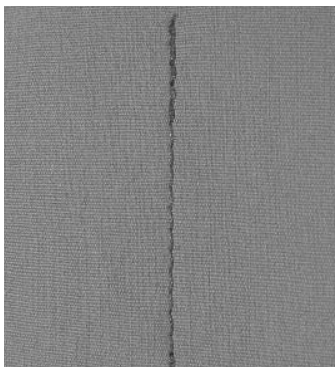

Securing stitch

- for all fabrics
- secures beginning and end of seam

Sewing long seams

- quicker securing at beginning and end of seam
- exact, regular and safe securing in all fabrics

Seam begin

- the sewing computer secures seam automatically (5 stitches forward, 5 stitches reverse)
- continue with straight stitch forward

Seam end

- press the Quick reverse button on head frame; the sewing computer secures automatically (5 stitches reverse, 5 stitches forward)
- the sewing computer stops automatically when securing is complete



Darning program



Stitch: **430: Darning program No. 18**
440 QE: Darning program No. 20
450: Darning program No. 22
 Needle: **size and type suitable for the fabric selected**
 Thread: **darning thread**
 Feed dog: **up**
 Presser foot: **Automatic buttonhole foot No. 3A**
430 / 440 QE: Reverse pattern foot No. 1
450: Reverse pattern foot No. 1C

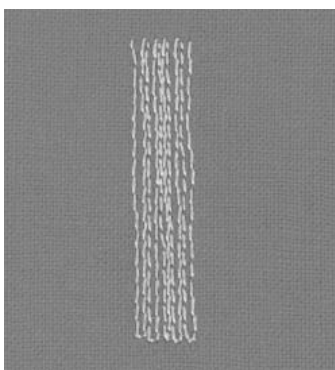

Quick darning of holes or worn areas

Replaces threads with the grain in all fabrics.

Preparation

- stretch fabric into darning hoop; prevents puckering

Move project accordingly for a wider and/or longer darning area.

Darning with Reverse pattern foot No. 1C, No. 1 (automatic stitch count)

- insert the needle in the top left of the worn area
- sew the first vertical row and stop the sewing computer
- press the quick reverse button on head frame (length is programmed)
- complete the Darning program, the sewing computer stops automatically
- clear the program by pressing the «clr» button



Reinforcement

- use fine fabric or interlining as a backing

Darning with the Automatic buttonhole foot with slide No. 3A

- only for small tears and worn areas for a darn of maximum 1 1/2" (3cm) in length
- same procedure as with foot No. 1C, No.1

Corrections of the automatic darning area

- if the darning becomes distorted, correct with the Balance (see page 22 for more information on the Balance function)

Manual darning



Stitch: **Straight stitch No. 1**
 Needle: **size and type suitable for the fabric selected**
 Thread: **darning thread**
 Feed dog: **down**
 Presser foot: **Darning foot No. 9**

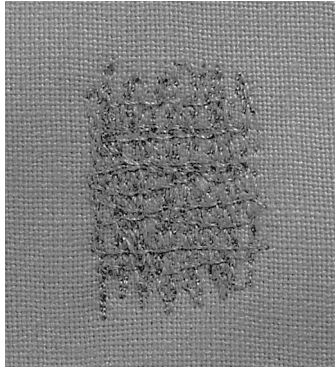

Darning holes or worn areas

Replaces both lengthways and crossways threads in all fabrics.

Preparation

- stretch fabric into darning hoop (optional accessory) to prevent distortion
- use the slide-on table



Poor stitch formation

- if the thread is lying on the right side of the fabric, the hoop is being moved too quickly
- if there are knots on the wrong side of the fabric, the hoop is being moved too slowly

Thread breaks

- if thread breakage is a problem, it could be that the hoop is not being moved smoothly

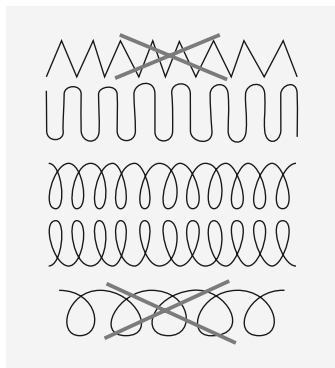

Sewing

- move the darning hoop smoothly by hand
- work from left to right without using pressure
- when changing direction on top and on bottom, move in curves (avoid points as this prevents holes and thread breakage)
- work in different lengths so that the thread is «lost» in the fabric

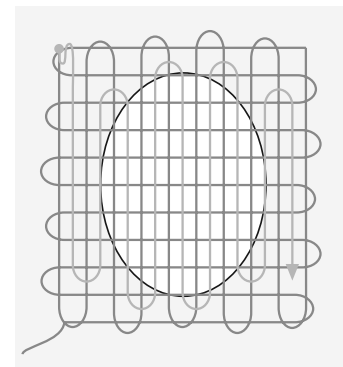
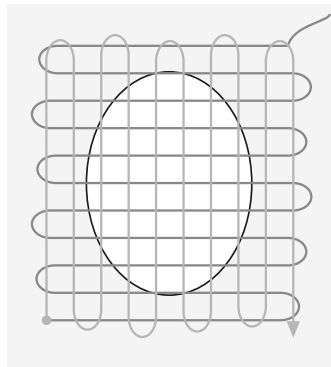
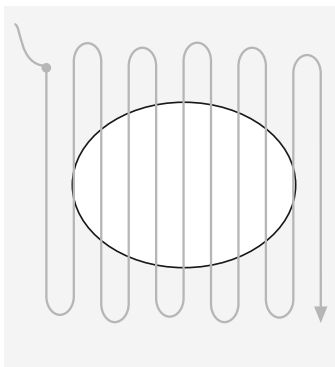

1. Stitch over the hole

- sew the first rows to cover the hole (not too close, sewing beyond the worn area)
- work the rows in irregular lengths
- turn work by a quarter turn - 90°

2. Cover the first rows

- sew over the first rows - not too close for a soft finish
- turn work by a half turn - 180°

3. Complete darning

- sew loosely and in same direction as 2nd rows

Zig-zag Stitch



Stitch: **Zig-zag stitch No. 2**
 Needle: **size and type suitable for the fabric selected**
 Thread: **cotton or polyester**
 Feed dog: **up**
 Presser foot: **430 / 440 QE: Reverse pattern foot No. 1**
450: Reverse pattern foot No. 1C

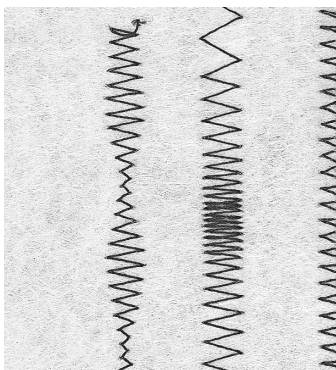

Zig-zag Stitch

- suitable for all fabrics
- overcasting
- elastic seams
- decorative sewing

Oversewing Edges

- guide edge of fabric into the center of the presser foot
- do not select too wide a width or too long a stitch – the edge should lie flat and not roll
- needle goes into fabric on one side and over the edge into the air on the other side
- use a fine darning thread for lightweight fabric



Oversewing edges

If edges roll, use the Vari-overlock stitch and foot No. 2A (450) / No. 2 (430 / 440 QE).

Embroidery with satin stitch

Experiment with adjusting the stitch width for new decorative effects.

Satin Stitch



- dense stitch used for appliqué, embroidery, etc.
- shorten stitch length, satin stitch setting will be indicated by parallel lines on stitch length bar

Sewing on Elastic, Shirring Elastic/Cord



Stitch: **430: Universal stitch No. 24**
440 QE: Universal stitch No. 26
450: Universal stitch No. 29
 Stitch width: **depends on width of elastic**
 Needle: **type and size to suit the fabric selected**
 Thread: **cotton or polyester**
 Feed dog: **up**
 Presser foot: **430 / 440 QE: Reverse pattern foot No. 1**
450: Reverse pattern foot No. 1C
Embroidery foot No. 6 (optional accessory)

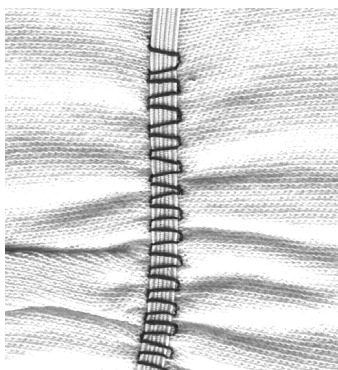

Sewing on Elastic

- for gathering long lengths of fabric
- for ruffles and flounces in fine fabrics, outer garments, sportswear, children's and doll clothing, crafts, etc.
- works well for gathered sleeve edges and neck openings

Preparation

- cut elastic to length required

Sewing

- oversew the elastic, adjusting the stitch width to be slightly wider than the elastic
- needle must not pierce the elastic
- after sewing, adjust the gathers evenly



Secure the beginning and end of elastic

Sew a few straight stitches backwards and forwards to secure the elastic.

Quick hem finish

- for children's or doll clothing
- sew sleeve edges with elastic before sewing seams

Stretch Overlock Seam



Stitch: **440 QE: Stretch overlock No. 23**
450: Stretch overlock No. 26
 Needle: **universal, ballpoint or stretch**
 Thread: **cotton or polyester**
 Feed dog: **up**
 Presser foot: **430 / 440 QE: Overlock foot No. 2, Reverse pattern foot No. 1**
450: Overlock foot No. 2A, Reverse pattern foot No. 1C

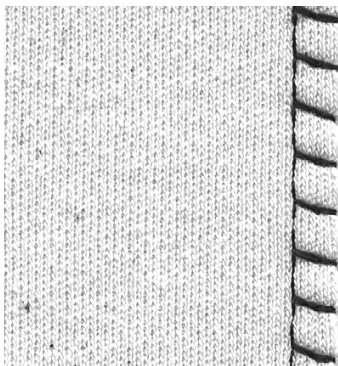

Closed Seam

- overlock seam in coarse or loose knits

Sewing

- sew stretch overlock along the fabric edge
- the stitch should sew over the edge of the fabric on the right swing of the needle

Vari-overlock seam



Stitch: **Vari-overlock No. 3**
 Needle: **size and type suitable for the fabric selected**
 Thread: **cotton or polyester**
 Feed dog: **up**
 Presser foot: **430 / 440 QE: Overlock foot No. 2, Reverse pattern foot No. 1**
450: Overlock foot No. 2A, Reverse pattern foot No. 1C



Overlock foot No. 2A, No. 2 is specially designed for overlock stitches. The pin on the foot allows for more thread in each stitch so that the elasticity of the seam is maintained.

Closed seam

Stretchy seam in fine, soft knits such as silk jersey and interlock.

Sewing

- guide the raw edge along the pin on the overlock foot
- the stitch will form over the pin and over the edge of the fabric

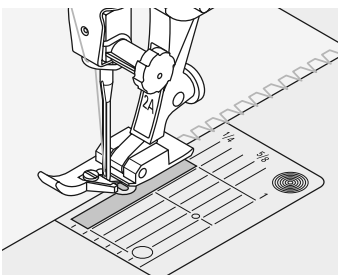

Double overlock seam



Stitch: **Double overlock No. 8**
 Needle: **size and type suitable for the fabric selected**
 Thread: **cotton or polyester**
 Feed dog: **up**
 Presser foot: **430 / 440 QE: Reverse pattern foot No. 1**
450: Reverse pattern foot No. 1C

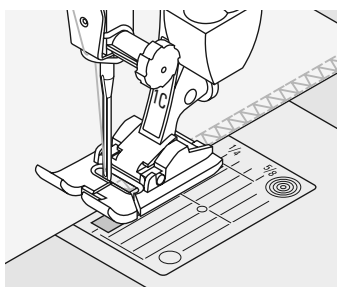
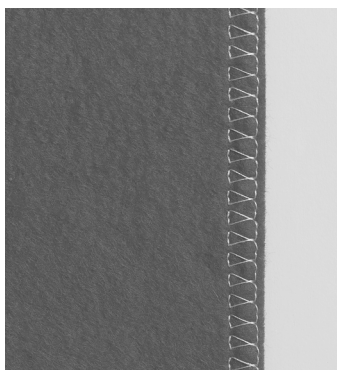

Closed seam

Overlock seam in loose knits and cross seams in knits and jerseys.

Sewing

- guide the raw edge along the pin on the overlock foot



Knits and jersey

- use a new Jersey needle to prevent damaging the loops

Sewing stretch fabrics

- if necessary use a stretch needle (130/705H-S) = needle point slides between the fibers

Flat Joining Seam



Stitch: **440 QE: Stretch overlock No. 23**
450: Stretch overlock No. 26
 Needle: **universal, ballpoint or stretch**
 Thread: **cotton or polyester**
 Feed dog: **oben**
 Presser foot: **430 / 440 QE: Reverse pattern foot No. 1**
450: Reverse pattern foot No. 1C

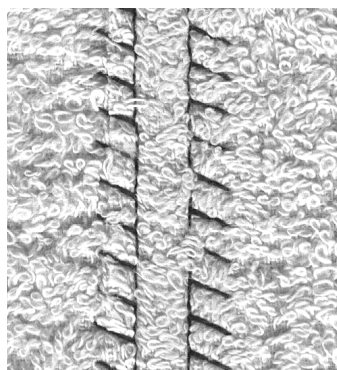

Flat Joining Seam

- fabric edges are overlapped and the stitch is placed on the seam allowance which produces a very flat, durable seam
- ideal for fluffy, thick materials such as terry cloth, felt and leather

Sewing

- sew stretch overlock along the fabric edge
- the stitch should sew over the edge of the top layer of fabric on the right swing of the needle



Fabric and thread

- When using a matching thread color, this seam is hardly visible in fluffy fabrics.

Zipper

Stitch:	Straight stitch No. 1
Needle:	size and type suitable for the fabric selected
Thread:	cotton or polyester
Feed dog:	up
Presser foot:	Zipper foot No. 4 Zipper foot No. 14 (optional accessory)
Needle position:	far right or far left

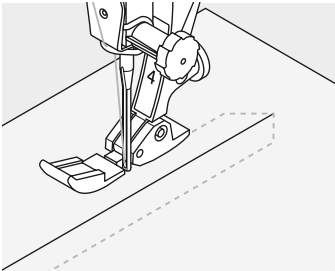
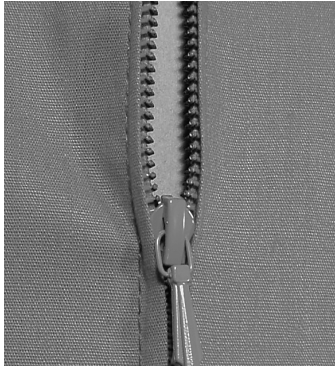

Preparation

- baste seam closed and clean finish the seam allowance
- baste or pin zipper in place so that fabric folded edges meet over the center of the zipper

Sewing

- open zipper a little
- start sewing from top left
- position the foot so the needle stitches along the edge of the zipper coils
- stop in front of the pull (needle position down), raise the presser foot and close zipper again
- continue to sew to the base of the zipper (needle position down)
- turn fabric and sew across the seam (needle position down)
- turn fabric again and sew second side of the zipper from bottom to top

Variation: Sew both sides of zipper from bottom to top

- suitable for all fabrics with nap or grain (e.g. velvet)
- prepare zipper as described above
- start sewing in the seam of the zipper end and sew first side from bottom to top
- sew the second side the same way from bottom to top



Zipper as a decorative element

- sew a visible zipper into the fabric as a decorative element

To sew around the zipper pull

- close the zipper and sew up to about 2" (5cm) away from the pull
- stop with the needle down in the fabric, raise the presser foot. Open zipper, pulling the tab below the needle; lower presser foot and continue to sew

Starting to sew

- hold threads firmly when starting to sew and pull the fabric gently behind the needle for a few stitches

Zipper tape or firm fabric

- for even stitch formation use a 90 - 100 needle

Piecing stitch / Straight stitch

Stitch:	Straight stitch No. 1
Needle:	size and type suitable for the fabric selected
Stitch length:	1.5mm – max. 2mm
Thread:	cotton or polyester
Feed dog:	up
Presser foot:	Patchwork foot No. 37 (optional accessory 430 / 450) Patchwork foot No. 57 (optional accessory)

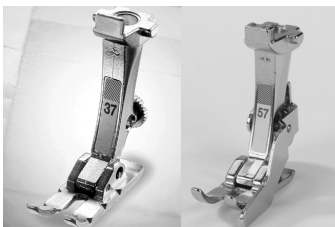

Patchwork foot

Accuracy is essential when sewing patches together. The side edges of the Patchwork foot are exactly 1/4" (6mm) from the center needle position. The center indents on either side of the foot indicate the needle insertion point and the two additional indents marking 1/4" (6mm) in front of and behind the needle. When you sew at a foot's width, the seam allowances will always be of the exact width and it is easy to turn the work while maintaining the



Attach the slide-on table for precise and easier work.

same width. Piecing patchwork is sewn with a straight stitch. A stitch length of 1.5-2mm is ideal. It is not necessary to secure the stitches for these relatively short seam lengths.

Blind hem



Stitch: **Blind hem No. 7**
 Needle: **size and type suitable for the fabric selected**
 Thread: **cotton or polyester/monofilament**
 Feed dog: **up**
 Presser foot: **Blindstitch foot No. 5**

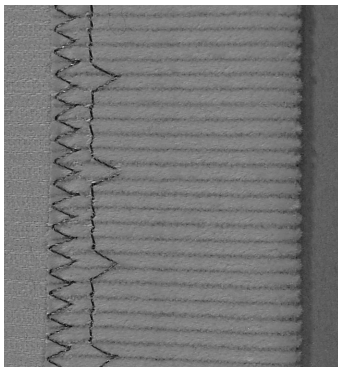

Blind hem

For invisible hems in medium to heavy cotton, wool and blended fabrics.

Preparation

- finish raw edges
- fold the hem and baste or pin in place
- fold the garment back over the right side of the fabric to expose the finished lower edge (see drawing)
- place work under the presser foot with the guide positioned against the folded back fabric

Sewing

- the needle should just pierce the edge of the fold (as with hand sewing)
- adjust the stitch width to suit the fabric
- after sewing about 4" (10cm), check both sides of fabric and adjust width again if necessary



Fine stitch width adjustment

- test-sew and adjust the stitch width if necessary. The needle should only just pierce the edge of the fold
- guide the folded edge evenly along the metal guide on the foot = even depth

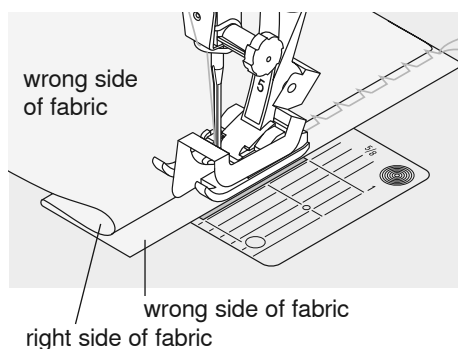

Basting stitch



Stitch: **430: Basting stitch No. 19**
440 QE: Basting stitch No. 21
450: Basting stitch No. 24
 Needle: **size and type suitable for the fabric selected**
 Thread: **cotton/polyester/darning thread**
 Feed dog: **down**
 Presser foot: **Darning foot No. 9**

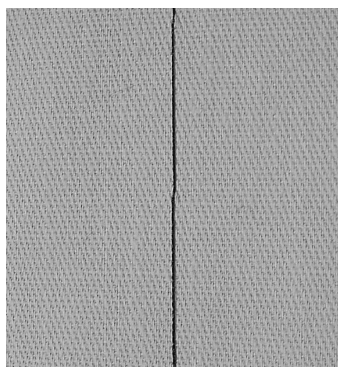

Basting stitch

- for all work which requires a very long stitch
- for basting seams, hems, quilts, etc.
- temporary joining
- easy to remove

Preparation

- pin work horizontally to basting direction to prevent the layers slipping

Basting (temporary joining)

- position work under the presser foot and sew one stitch; hold threads when starting to sew
- pull work from behind to the required length of the stitch
- sew one stitch and repeat the procedure



Securing/fixing the thread

- sew a few basting stitches at the beginning and end of a seam

Basting

- use a fine darning thread for basting as it is easier to remove

Decorative stitches

Stitch: **Decorative stitch**
 Needle: **size and type suitable for the fabric selected**
 Thread: **cotton, decorative**
 Feed dog: **up**
 Presser foot: **430 / 440 QE: Reverse pattern foot No. 1**
450: Reverse pattern foot No. 1C
Open embroidery foot No. 20 (optional accessory for aurora 430 / 450),
Embroidery foot No. 6 (optional accessory),
Reverse Pattern foot with clear sole No. 34 (optional accessory),
Embroidery foot with clear sole No. 39 (optional accessory)

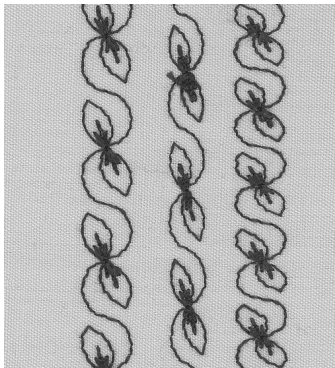

A B C

- A** decorative stitch with preset width and length
- B** decorative stitch with reduced width
- C** decorative stitch with shortened length

Decorative stitches

- for any material
- to decorate and embellish

Stitch selection

- press appropriate button

Altering the basic settings

- stitches can be adjusted to suit your own tastes
- reduce stitch width, e.g. for doll clothes

Altering stitch width

- ⊕ wider
- ⊖ narrower



Altering stitch length

- ⓪ shorter
- Ⓜ longer

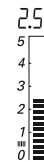

Decorative stitches on single layer of fabric

- always use stabilizer as a backing and remove stabilizer after sewing is complete

Deleting functions

- press the «clr» button
- delete special functions individually by pressing the appropriate function button

Activate needle stop down when sewing long seams

- prevents fabric slipping when stopping to adjust it

Activate pattern end function while sewing

- sewing computer stops after each active stitch

combining with functions

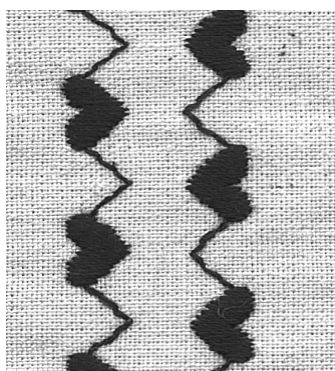

B A

- every stitch can be combined with different functions
- more than one function can be used with individual stitches

Method

- select stitch **A**
- sew



- select function (e.g. mirror image) **B**
- sew

Combining basic settings and functions

- you can achieve some exciting effects by combining basic settings with various functions

Deleting functions

- press the «clr» button
- delete special functions individually by pressing the appropriate function button

Hand-look quilt stitch

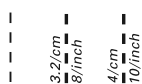

Stitch:	430: Quilt stitch No. 49
	440 QE: Quilt stitch No. 44, No. 60, No. 61
	450: Quilt stitch No. 62
Needle:	size and type suitable for the fabric selected
Upper thread:	monofilament
Bobbin thread:	30/2 cotton thread
Feed dog:	up
Presser foot:	430 / 440 QE: Reverse pattern foot No. 1
	450: Reverse pattern foot No. 1C
	Walking foot No. 50 (optional accessory for aurora 430 / 450)

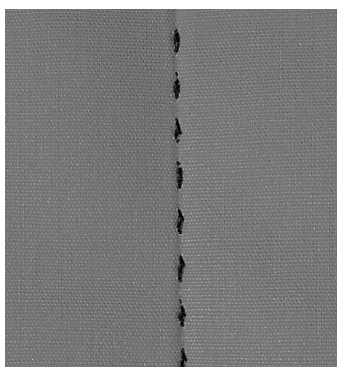

Hand-look quilt stitch

Suitable for all fabrics and work which should look «hand sewn».

Sewing test

- the bobbin thread is pulled to the right side
- 1 stitch is visible (bobbin thread)
- 1 stitch is invisible (monofilament) = hand-look effect

Upper thread tension

- depending on the fabric = increase the tension (6–9)

Balance

- adjust stitch with the Balance if necessary



Perfect corners

- activate Pattern end and Needle stop down and pivot the work
- when pivoting make sure that the fabric does not become distorted

Monofilament breaks

- sew more slowly
- reduce upper thread tension slightly

Freehand quilting



Stitch:	Straight stitch No. 1
Needle:	size and type suitable for the fabric selected
Thread:	monofilament or cotton
Feed dog:	down
Presser foot:	Darning foot No. 9, Quilting foot No. 24 (optional accessory)
	Quilting foot No. 29 (optional accessory)

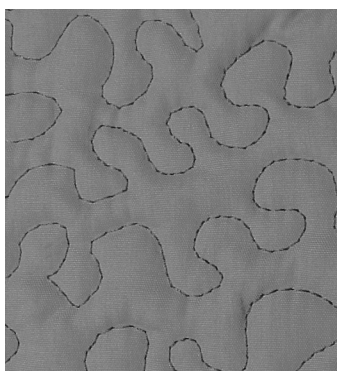

Freehand quilting

- for all freehand quilt work

Preparation

- pin and baste top layer, batting, and lining together
- attach the slide-on table

Holding the work

- hold the fabric with both hands like an embroidery frame
- start in the center and work out toward the edges

Quilting a design

- turn the work using smooth, round movements to form the design of your choice



Stipple quilting

- technique covers the entire surface of the fabric
- the lines of stitching are rounded without any sharp corners; they never cross nor touch one another

Freehand quilting with BSR

Stitch: **Straight stitch No. 1**
 Needle: **size and type suitable for the fabric selected**
 Thread: **monofilament or cotton**
 Feed dog: **down**
 Presser foot: **BSR foot No. 42**

BSR (BERNINA Stitch Regulator) function

This function using the BSR presser foot allows for free-motion quilting (sewing) using the straight stitch and a pre-selected stitch length (up to 4mm). The BSR presser foot reacts to the movement of the fabric under the foot and controls the speed of the sewing computer up to the maximum possible speed.

The following applies: the faster the fabric is moved the higher the speed of the sewing computer. A regulated set stitch length is maintained within a certain speed, independent of the movement of the fabric. If the fabric is moved too fast an acoustic signal is heard, provided the beeper function has been previously activated. (see page 46).



By activating the BSR function the sewing computer sews either continuously at a reduced motor speed (mode 1, standard) or on moving the fabric (mode 2). As long as the BSR presser foot is illuminated red, adjustments like threading and changing the needle, for example must not be carried out. The sewing computer is still in BSR mode and the needle will engage while fabric is moved unintentionally! Without fabric feed the BSR mode is turned off after approx. 7 seconds and the red light goes off. Please refer to the Safety Instructions!

BSR function can be sewn in 2 separate modes of operation

BSR 1

- BSR mode 1 is the active standard
- on pressing the foot control or the Start-/Stop button, the needle starts to move continuously
- moving the fabric under the foot will engage the sewing computer to accelerate
- through the continuous needle movement securing in the same position is possible without pressing an additional button

BSR 2

- press external button No. 2 of the stitch selection (see page 29) to engage BSR mode 2
- the sewing computer only starts if the foot control or Start-/Stop button is pressed and the fabric moved simultaneously
- the movement of the fabric determines the sewing speed
- for securing, the «Securing function» button must be pressed
- press external button No. 1 of the stitch selection to engage BSR mode 1



For an even sewing start (one single stitch) the foot control must be pressed and the fabric moved **simultaneously**. This also applies for sewing points and straight stitching within a round form.

When resuming work with the BSR presser foot after exiting the function, the BSR mode that was active at the time of exiting the BSR function will be activated, even if the sewing computer was turned off in the meantime.

Preparation

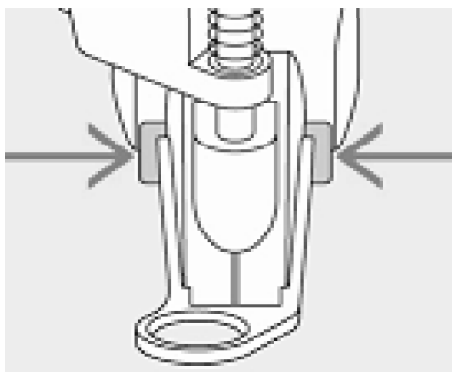
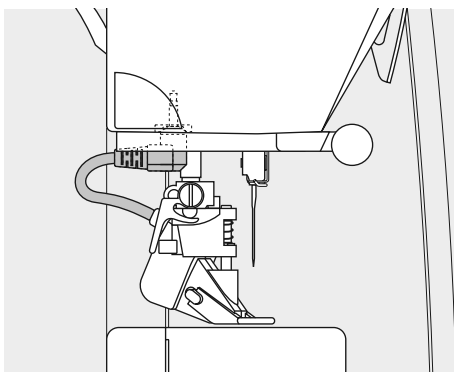

- it is not possible to switch to BSR mode, once a buttonhole is selected
- select straight stitch first

- lower the feed dog
- presser foot pressure must be reduced depending on the fabric type and thickness

- attach the desired presser foot sole to the BSR presser foot
 - removing sole: press both buttons (see arrows) on each side of the foot
 - slide the sole down the groove at an angle
 - attaching the sole: slide the sole up in the groove until it clicks into place

- attach the BSR presser foot to the sewing computer and plug the cable into the green socket until it clicks into place
- «BSR» blinks on the left side on the display
- press the BSR button
- «BSR» is visible on the display = Mode 1 (Standard)
- the basic stitch length setting is 2mm
- set the desired stitch length
- when sewing small forms and stippling, stitch length of 1mm - 1.5mm is suggested

Using the following functions in the BSR mode

Needle stop down (default)

- the arrow points down on the display = the sewing computer stops with needle down, when taking foot off foot control

Needle stop up

- press the needle stop button (arrow points up) = the sewing computer stops with needle up, when taking foot off foot control

Raise or lower the needle

- press the needle stop button longer - or by pressing the heel on the foot control, the needle can be lowered or raised

Securing with Start-/Stop button (only mode 1)

- place fabric under presser foot, then lower presser foot
- press needle stop button twice to take up lower thread
- hold upper and lower thread and press the Start-/Stop button to start the BSR mode
- sew 5-6 securing stitches
- press the Start-/Stop button to stop the BSR mode
- cut the threads
- press the Start-/Stop button to restart the BSR mode and continue the quilting

Securing function (only mode 2)

- press the «Securing function» button
- press the foot control or Start - Stop button 
- short securing stitch sequence will be sewn as soon as the fabric is moved under the presser foot. After the sequence is sewn the set stitch length will be activated and the securing function will be automatically deactivated

Activating/deactivating the beeper (acoustic signal)

- press mode 1 or 2 long
- an acoustic tone will beep indicating beeper activation
- an acoustic tone beeps to indicate the sewing computer is running at maximum motor speed
- sewing with min. stitch length = maximum movement of fabric under the presser foot is slower
- keep mode button (1 or 2) pressed a while again to deactivate the beeper
- the beeper remains as selected (on or off) when exiting the BSR mode



When exceeding a certain speed, adhering to regular stitch length cannot be guaranteed.

Make sure that the lens on the bottom of the BSR foot is not dirty (fingerprints, etc.). Clean lens periodically with soft, slightly damp cloth.

Free hand quilting without BSR activation



- press the BSR/Balance button - «BSR 1» goes off
- the BSR symbol blinks on the left side on the display
- normal free hand quilting can now be sewn with the BSR foot, **without automatic regular stitch length**

Activating the BSR sewing function

1. With the foot control

- plug in the foot control
- lower the presser foot
- start the BSR mode by pressing the foot control, the «BSR active» symbol appears on the display 
- a red light appears on the presser foot
- the foot control must be pressed continuously during sewing
- the speed of the sewing computer will be regulated by the movement of the fabric
- by releasing the foot control the BSR mode will be stopped

2. With the Start-Stop button

- unplug the foot control 
- lower the presser foot
- start the BSR mode by pressing the Start-Stop button, the «BSR active» symbol appears on the display 
- a red light appears on the presser foot
- the speed of the sewing computer will be regulated by the movement of the fabric
- press the Start-/Stop button again or actuate the presser foot lifter to stop the BSR mode

Using the Start-/Stop button to deactivate the BSR function

In mode 1:

- if the fabric is not moved for about 7 seconds, the BSR mode deactivates (display switches to BSR) and the red light on the presser foot goes out

In mode 2:

- if the quilting is stopped by stopping to move the fabric, an additional stitch will be sewn depending on the needle position. The sewing computer will always stop with the needle up, even if the arrow in the screen points down

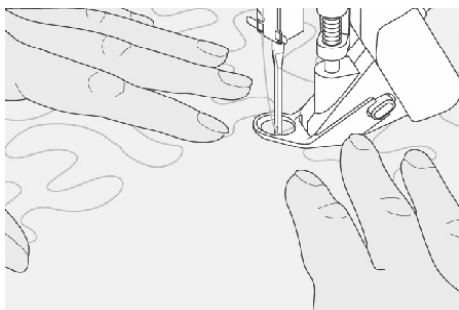

Holding the work

- hold and guide the taut fabric with both hands
- if the fabric is moved abruptly (sudden stops or quick acceleration), some stitches may turn out slightly shorter or longer
- continuous movement of the fabric (no abrupt movements) under the foot will provide best results
- move the fabric in one direction for best results

BSR-mode deactivation

- pull out the plug of the BSR presser foot connection cable on the sewing computer
- remove the BSR presser foot

Buttonholes - Important information

aurora 430 / 440 QE

Thread tension

- thread the bobbin thread through the finger of the bobbin case = the bobbin tension is a little tighter
- this gives the beads on the right side of the fabric a slightly rounded appearance
- the buttonhole looks more attractive
- gimp reinforces buttonholes and enhances their appearance
- sew both beads at the same speed

aurora 450

Thread tension

- set upper thread tension to 2.5 (Buttonhole symbol)
- the bobbin tension is a little tighter which gives the beads on the right side of the fabric a slightly rounded appearance
- the buttonhole looks more attractive
- gimp reinforces buttonholes and enhances their appearance
- sew both beads at the same speed

Marking buttonhole

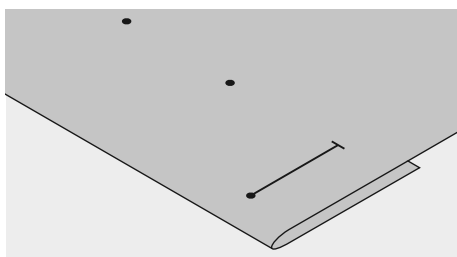
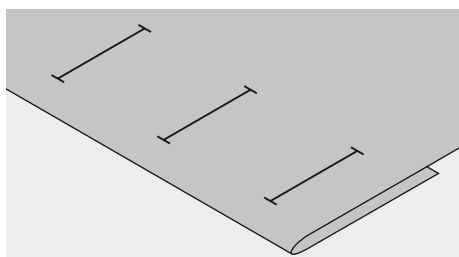

Manual buttonhole

- mark the buttonhole length in the desired position
- use Buttonhole foot No. 3C, 3 (optional accessory)

Automatic buttonhole

- mark the length of just one buttonhole
- after sewing the first buttonhole, the length for all subsequent buttonholes is automatically programmed
- mark only the beginning of all subsequent buttonholes
- use Automatic buttonhole foot No. 3A

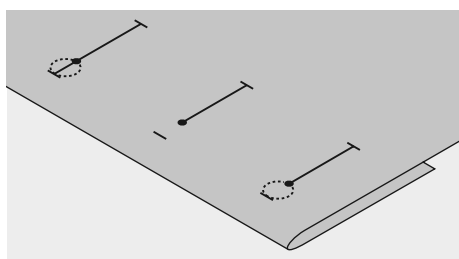

Keyhole buttonhole

- mark the bead length only
- the correct length eye will be added when the buttonhole is sewn

Test sewing

- always sew a test sample on the fabric with stabilizer you intend to use
- select the buttonhole type you intend to use
- sew the buttonhole in the same direction on the fabric (with or against the grain)
- cut the buttonhole open
- push the button through
- adjust the buttonhole length if necessary

Bulky buttons

- with bulky buttons (roll crown, bulge-rimmed etc.) add approx. 3-5mm to the buttonhole length (depending on the size and bulk of the button)

To adjust the bead width:

- alter the stitch width

Stitch length adjustments:

- Stitch length adjustments affect both buttonhole beads (spacing between the stitches)
- reprogram the buttonhole length after changing the stitch length

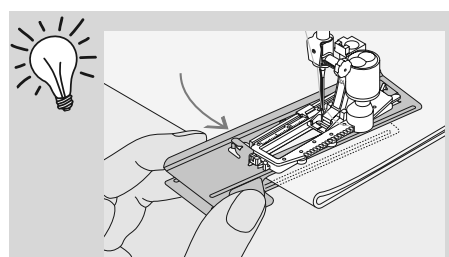

Using the compensation plate (in some countries only available as optional accessory) is recommended when sewing buttonholes in difficult fabrics. It can be used with the Automatic buttonhole foot No. 3A or the buttonhole foot No. 3B.

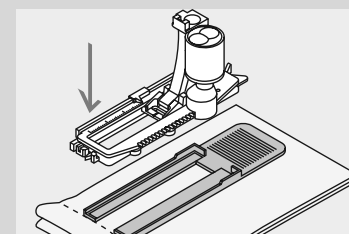

If a buttonhole is to be sewn at right angles to a seam, we recommend the use of the height compensating plates for buttonholes (available as optional accessory). Place the plates from the back between fabric and bottom of slide foot up to the thick part of the fabric and push to front.

Correct interfacings or stabilizers for buttonholes

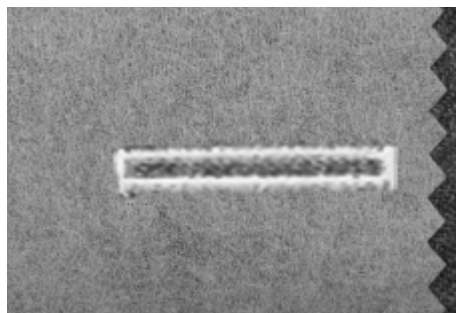
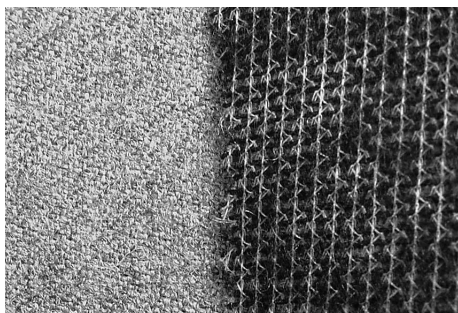

- for best results always sew buttonholes on area that is lined with interfacing
- the interfacing should suit the fabric type
- for thick and fluffy fabrics an embroidery stabilizer can be used. The fabric feeds better

Buttonholes with cord

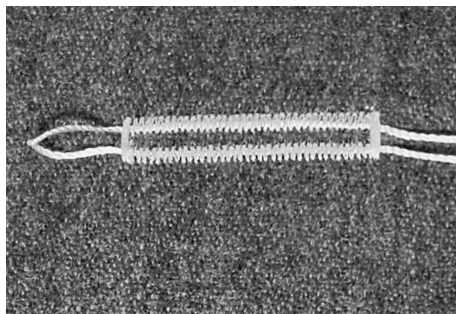
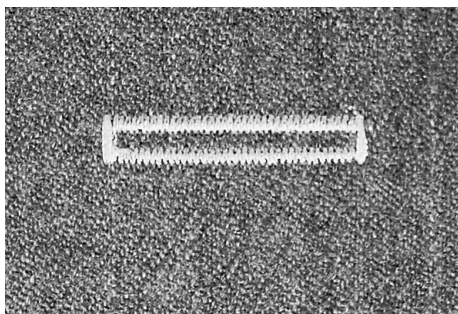

Cord

- use cording to reinforce buttonholes and enhance their appearance
- the loop of the cord should be at the end of the buttonhole most subject to wear
cord loop = where button is sewn on
- position the work accordingly

Ideal cords

- Perle cotton No. 8
- strong hand-sewing thread
- fine crochet yarn

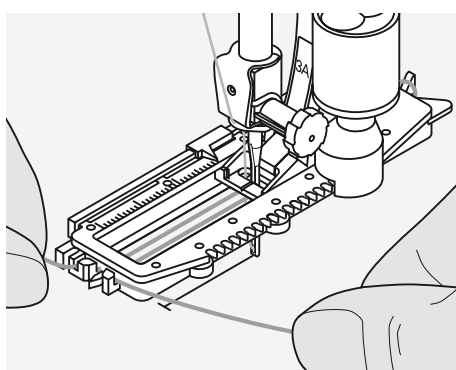
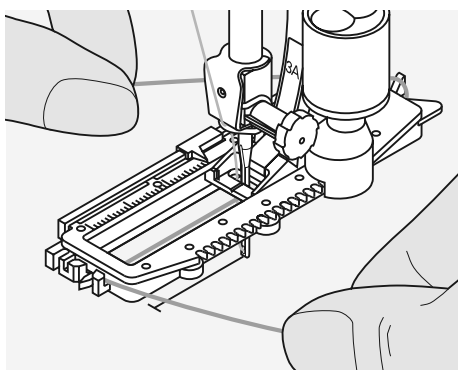

Hooking the cord in the Automatic buttonhole foot with slide No. 3A

- insert the needle at the beginning of the buttonhole
- raise the presser foot
- guide the cord under the foot to the right
- hook the cord over the pin at the back of the foot
- bring the cords to the front of the foot
- pull them into the slit

Sewing

- sew the buttonhole in the usual manner, do not hold the cord tightly
- the buttonhole will form over the cord, covering it

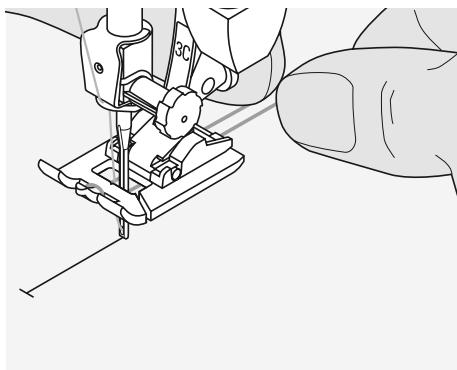
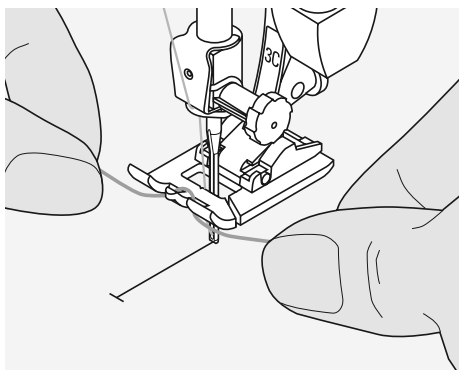

Hooking the cord onto presser foot No. 3C, No. 3 (special accessory)

- insert the needle at the beginning of the buttonhole
- raise the presser foot
- hook the cord over the center pin on the front of the foot
- place both ends of the cord in the grooves on the sole of the foot and pull them to the back
- lower the presser foot

Sewing

- sew the buttonhole in the usual manner, do not hold the cord tightly
- the buttonhole will form over the cord, covering it

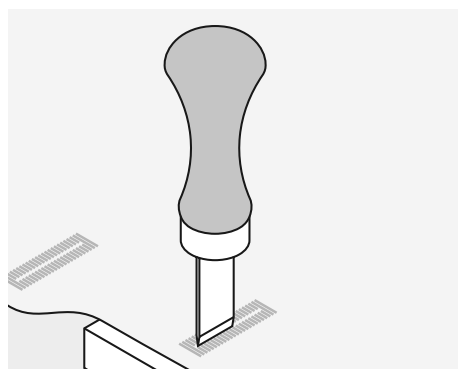
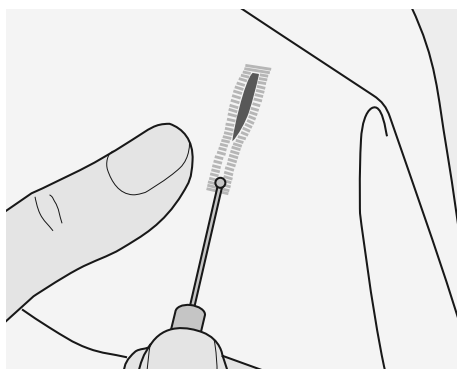
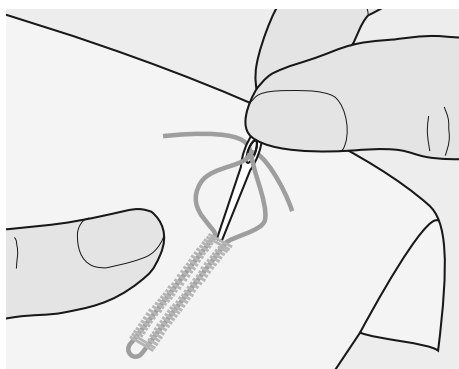

Securing the cord

- pull the cord through the buttonhole until the loop disappears into the end of it
- pull the ends of the cord through to wrong side of the fabric
- knot or secure with stitches

Cutting buttonholes open

- using the seam ripper, cut from the ends towards the middle
- in order not to cut the ends of short buttonholes by mistake, place a pin at the end of the buttonhole for additional security

Buttonhole cutter and block (special accessory)

- place the fabric on the wood
- place the cutter in the center of the buttonhole
- press down on the cutter with your hand or a hammer

Buttonhole - Balance

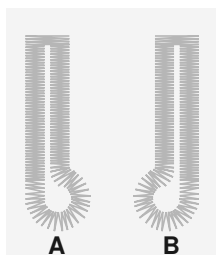

When all buttonholes have been sewn, return Balance to the normal setting!

Balance for automatic and manual buttonholes

- any Balance alterations to the manual and auto length buttonholes affect both beads identically because they are sewn in the same direction
- the keyhole or eye is balanced as follows:
- sew straight stitches until the sewing computer changes to the keyhole or eye, then stop the sewing computer
- press the Balance button

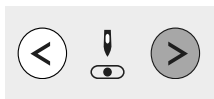

Keyhole is distorted to the right (picture A):

- press the right Needle position button = the keyhole will be corrected to the left
- sew a test!

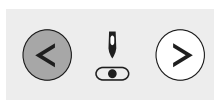

Keyhole is distorted to the left (picture B):

- press the left Needle position button = the keyhole will be corrected to the right
- sew a test!

Buttonholes

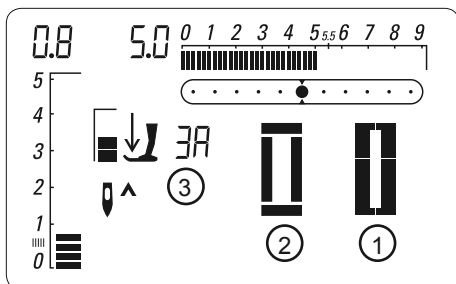

aurora 430

- No. 10 Standard buttonhole
- No. 11 Narrow buttonhole
- No. 12 Stretch buttonhole
- No. 13 Keyhole buttonhole
- No. 14 Straight stitch buttonhole
- No. 15 Hand-look buttonhole

aurora 440 QE

- No. 10 Standard buttonhole
- No. 11 Narrow buttonhole
- No. 12 Stretch buttonhole
- No. 13 Round buttonhole
- No. 14 Keyhole buttonhole
- No. 15 Straight stitch buttonhole
- No. 16 Hand-look buttonhole

aurora 450

- No. 10 Standard buttonhole
- No. 11 Narrow buttonhole
- No. 12 Stretch buttonhole
- No. 13 Round buttonhole
- No. 14 Round buttonhole with square end
- No. 15 Keyhole buttonhole
- No. 16 Keyhole buttonhole with tapered end
- No. 17 Heirloom buttonhole
- No. 18 Straight stitch buttonhole

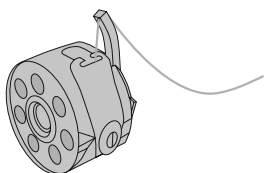

Buttonholes are not only practical closures, they can also be used for a decorative effect.

Preparation

- **430 / 440 QE:** thread the lower thread in the finger of the bobbin case
- **450:** set upper thread tension to 2.5 (Buttonhole symbol)
- use Buttonhole foot with slide No. 3A or Buttonhole foot No. 3C, No. 3 (special accessories)

- Select the buttonhole of your choice, the following appears on the display:
 - 1** Buttonhole graphic
 - 2** Buttonhole symbol
 - 3** Presser foot indicator

Manual buttonhole

- Stitch: **any buttonhole**
- Needle: **size and type suitable for the fabric selected**
- Thread: **cotton or polyester**
- Feed dog: **up**
- Presser foot: **Buttonhole foot No. 3C, No. 3 (optional accessory)**

Preparation

- select the desired buttonhole
- display shows:
 - buttonhole graphic
 - presser foot indicator No. 3A
 - the buttonhole symbol (the first step blinks on the display)

The active step blinks on the display. Sew both beads at the same speed.



Sewing buttonholes manually is ideal if you only need to sew one; also for repairing existing buttonholes. The number of steps depends on the type of buttonhole selected. A manual buttonhole cannot be saved.

4-step standard buttonhole

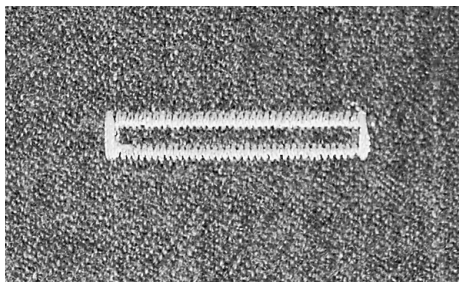

1. sew the first bead forward up to the length mark, stop the sewing computer
 - press the Quick reverse button



2. sew reverse straight stitch, stop the sewing computer at the first stitch (buttonhole begin)
 - press the Quick reverse button



3. sew the top bartack and the second bead, stop the sewing computer
 - press the Quick reverse button



4. sew the bottom bartack and securing stitches

5 step keyhole buttonhole

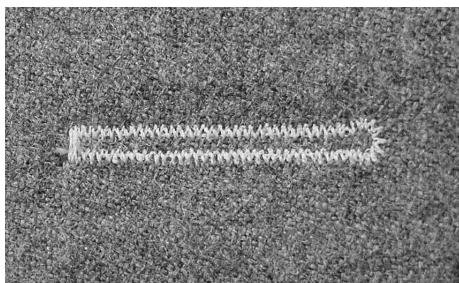

1. sew straight stitch forwards, stop the sewing computer
 - press the Quick reverse button



2. sew the eye and the first bead in reverse, stop the sewing computer at the first stitch (buttonhole begin)
 - press the Quick reverse button



3. sew straight stitch forwards and stop the sewing computer at the keyhole
 - press the Quick reverse button



4. sew the second bead in reverse, stop the sewing computer at the first stitch (buttonhole begin)
 - press the Quick reverse button



5. sew bartack and securing stitches

Automatic buttonhole

Stitch:	Buttonhole (all types)
Needle:	size and type suitable for the fabric selected
Thread:	cotton or polyester
Feed dog:	up
Presser foot:	Automatic buttonhole foot No. 3A

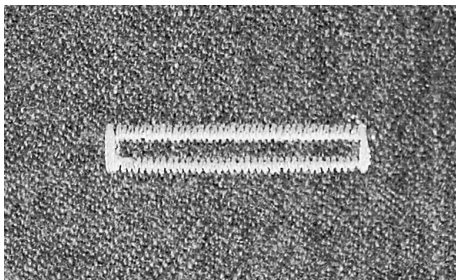

Automatic buttonhole

- the lens on automatic buttonhole foot 3A automatically registers the length of the buttonhole for exact duplication
- the active step blinks on the screen
- both beads are sewn in the same direction



The slide foot must lie perfectly flat on the fabric. If the slide foot lies on a seam, the length cannot be measured accurately.

Buttonhole in long term memory

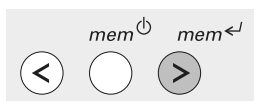

Saving programmed buttonholes in long term memory

- after programming press the *mem* button
- the buttonhole is now saved in long term memory

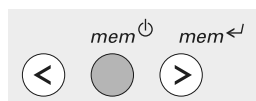

Opening saved buttonholes

Programmed saved buttonholes can be opened for re-use even after the sewing computer has been disconnected.

- select the buttonhole
- press the *mem* button
- sew the programmed buttonhole
- only one of any style buttonhole can be saved, if a new length is saved with *mem*, it overwrites the previously saved buttonhole



Sewing speed

- sew at moderate speed for best results
- sew all buttonholes at the same speed for consistent bead density

Exact duplicates

- the auto function ensures that each buttonhole will be exactly the same length as the previous one

Double sewn keyhole buttonholes

- keyhole buttonholes can be sewn twice on thick fabrics
- after sewing the first buttonhole, do not move the work
- simply tap the foot control once to begin sewing again

Programming the standard and stretch buttonhole

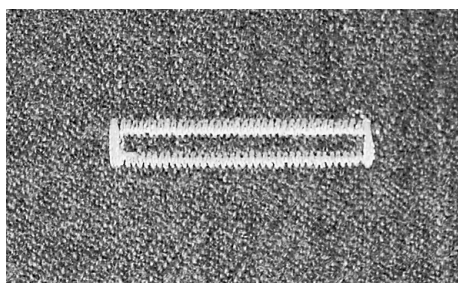

 **Deleting the programming**
Press the «clr»-button to delete the program.

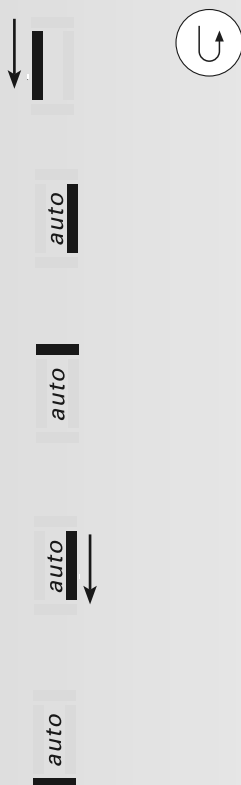

1. sew the first bead forwards, stop the sewing computer
 - press the Quick reverse button
 - «auto» is indicated on the display = the buttonhole length is programmed

2. the sewing computer sews reverse straight stitch automatically

3. the first bartack

4. the second bead forwards

5. the second bartack and securing stitches
 - sewing computer stops and returns automatically to buttonhole begin
 - all subsequent buttonholes will be sewn to exactly the same length (no need to press the Quick reverse button)

Programming the round and keyhole buttonhole

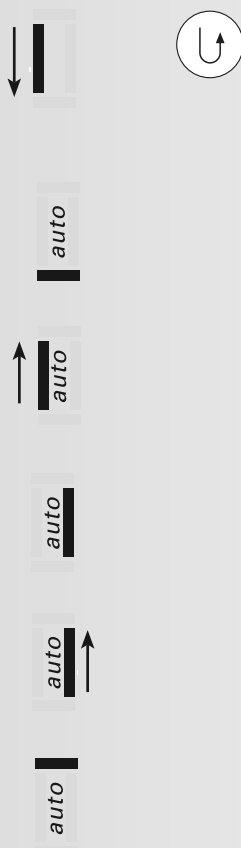
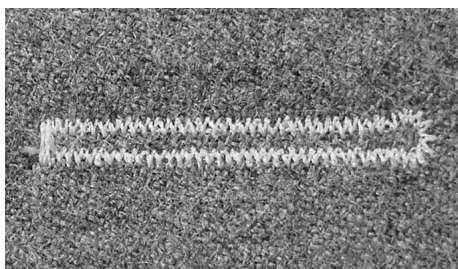

1. sew the straight stitch forward, stop the sewing computer
 - press the Quick reverse button
 - «auto» is displayed on the display = buttonhole length is programmed

2. the sewing computer automatically sews the eye

3. the first bead in reverse

4. sews straight stitches forwards

5. sews second bead in reverse

6. sews bartack and securing stitches
 - the sewing computer stops and returns automatically to buttonhole begin
 - all subsequent buttonholes will be sewn to exactly the same length (without pressing the Quick reverse button)

Eyelets



Stitch:	430:	Straight stitch eyelet No. 17
	440 QE:	Straight stitch eyelet No. 19
	450:	Straight stitch eyelet No. 21
	440 QE:	Narrow zig-zag eyelet No. 18
	450:	Narrow zig-zag eyelet No. 26
Needle:	size and type suitable for the fabric selected	
Thread:	cotton / polyester	
Feed dog:	up	
Presser foot:	430 / 440 QE:	Reverse pattern foot No. 1
	450:	Reverse pattern foot No. 1C

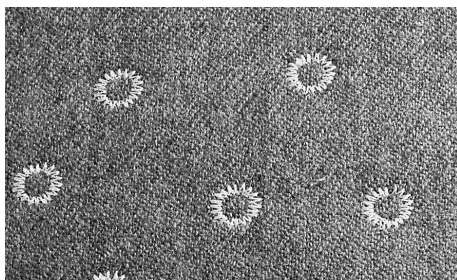
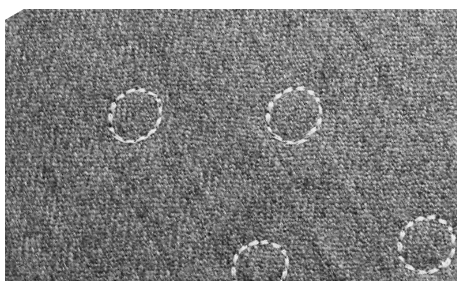

Sewn eyelet

- opening for cord and narrow ribbon
- for decorative work, children's clothing, crafts
- cannot be saved

Sewing eyelets

- select eyelet
- sew program
- sewing computer stops automatically when finished
- sewing computer is ready to sew the next eyelet

Cutting eyelets open

- use an eyelet punch



Eyelets

- ideal as eyes for soft toys, dolls or puppets

More marked appearance

- thread bobbin thread in finger on bobbin case (430 / 440 QE) = tighter bobbin tension
- for embellishment or as a reinforced opening for ties etc.

Button sew-on program



Stitch:	430:	Button sew-on program No. 16
	440 QE:	Button sew-on program No. 17
	450:	Button sew-on program No. 19
Stitch width:	depends on distance between the holes	
Needle:	size and type suitable for the fabric selected	
Thread:	cotton or polyester	
Feed dog:	down	
Presser foot:	Darning foot No. 9	
	Button sew-on foot No. 18 (optional accessory)	

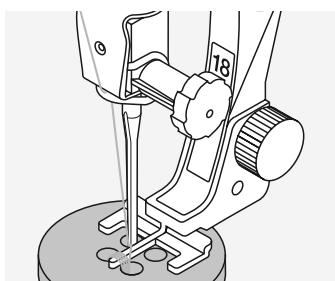
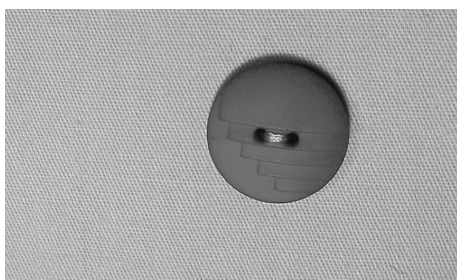

Sewing on buttons

- sews buttons with 2 or 4 holes
- buttons being sewn on for decorative purposes only can be stitched without forming a thread shank
- the shank (= thread length between button and fabric) can be made shorter or longer as required with foot No. 18

Beginning and finishing threads

- the threads are secured and can be trimmed
- after sewing on the button, pull the upper thread ends through to the wrong side and knot

Sewing on buttons with darning foot No. 9

- select Button sew-on program
- check distances between holes with the handwheel and adjust stitch width if necessary
- sew the securing stitches; hold the threads when starting to sew
- sew
- sewing computer stops automatically when program is completed and is ready for the next button

Cleaning

If the sewing computer is stored in a cold room, it should be brought to a warm room about one hour before use.



Cleaning the stitch plate

Periodically remove thread lint and remnants which collect under the stitch plate and the hook.

- turn power switch to «0» (off) and pull out plug from electrical outlet
- remove presser foot and needle
- open the free arm cover
- press the stitch plate down at the back right corner, lift and remove
- clean the area with the lint brush
- replace the stitch plate

Cleaning the screen and the sewing computer

- wipe with a damp cloth

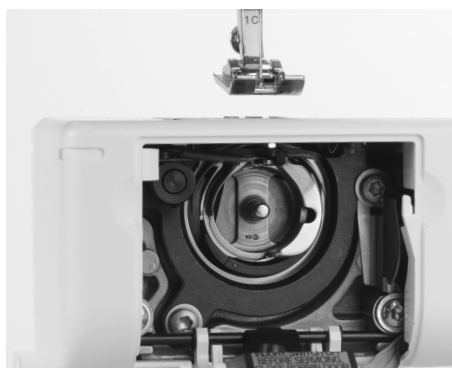

Cleaning the hook

aurora 430 / 440:

- turn power switch to «0» (off) and pull out plug from electric outlet
- remove the bobbin case
- push the release lever to the left
- let down the locking lever and the black hook race cover
- remove the hook
- clean the hook race, never use a sharp instrument
- replace the hook, turning the handwheel if necessary so that the hook driver is on the left
- close the hook race cover and secure with the locking lever, the locking pin must engage
- check by turning the handwheel
- insert the bobbin case

aurora 450:

- turn power switch to «0» (off) and pull out plug from electric outlet
- remove the bobbin case
- clean the hook race, never use a sharp instrument
- insert the bobbin case



Lubricating

- turn power switch to «0» (off) and pull out plug from electric outlet
- squeeze one drop of oil into the hook race
- run the sewing computer for a short time without thread to prevent oil soiling your work



Disconnect plug from the socket before cleaning or lubricating!



Never use alcohol, petrol, white spirit or any type of solvent to clean the sewing computer!

Cleaning notification



- visible on the display when the sewing computer must be cleaned/oiled (after approx. 180,000 stitches)
- if the sewing computer was cleaned the display can be cleared by pressing the «#» button twice
- the display can be cleared temporarily by pressing the «clr» button but will appear again when restarting the sewing computer
- after clearing with «clr» for the third time the cleaning notification will only appear again after a further approx. 180,000 stitches

Service notification



- visible on the display when the sewing computer must be taken for a service to the BERNINA dealer (after approx. 2,000,000 stitches)
- if the service was done by the BERNINA dealer the stitch counter will be on «0» again and the display does not appear anymore
- the display can be cleared temporarily by pressing the «clr» button but will appear again when restarting the sewing computer
- after clearing with «clr» for the third time the service notification does not appear anymore - the next service notification will be at approx. 4,000,000 stitches

Environmental Protection



BERNINA is committed to the protection of the environment. We strive to minimize the environmental impact of our products by continuously improving product design and our technology of manufacturing.

At end of life please dispose this product in an environmentally responsible way according to the national directive. Do not throw away this product with your household waste. In case of doubt, please contact your dealer.

Trouble shooting

In most cases you will be able to identify and remedy faults by checking the following.

Check whether:

- the upper and lower threads are threaded correctly
- the needle is inserted correctly with the flat side to the back
- the needle size is correct – check the needle/thread table on p. 18
- the needle tip and shaft are undamaged
- the sewing computer is clean – brush out any thread lint
- the hook race is clean
- any threads are trapped between the tension discs or under the bobbin case spring

Fault	Cause	Repair
Uneven stitch formation	Upper thread too tight/too slack Lower thread too tight/too slack Poor quality needle Needle inserted incorrectly Poor quality thread Needle/thread combination is incorrect Incorrectly threaded	Reduce/increase upper thread tension Reduce/increase lower thread tension Use a needle with flat side of the shank to the back The flat side of the shank must be to the back Use quality threads (Isacord, Mettler, Gütermann) Match the needle to the thread size Check upper thread threading path/lower thread threading path
Skipped stitches	Incorrect needle system Needle bent or blunt Poor quality needle Needle inserted incorrectly Incorrect needle point	Use needle system 130/705 H Use good quality needles Use new, good quality needles (BERNINA). Insert needle as far as it will go Match the needle type to the fabric
Upper thread breaks	Upper thread tension too tight Incorrectly threaded Poor quality or old thread Stitch plate or hook tip damaged	Reduce upper thread tension Check upper thread threading path Use good quality thread Have the sewing-/embroidery computer checked by a dealer
Lower thread breaks	Lower thread tension too tight Stitch hole in the stitch plate has been damaged Needle blunt or bent	Reduce lower thread tension Have the sewing-/embroidery computer checked by a dealer Use a new needle
Needle breaks	Needle not correctly inserted Fabric was pulled Fabric was pulled when thick material used Poor quality thread, unevenly wound or knotted	Tighten the needle clamp screw Do not pull the fabric during sewing Use the correct presser foot for thick material (e.g. Jeans foot No. 8) Use height compensating tool when sewing over a thick seam Use quality thread
Sewing computer fails to run or runs slowly	Plug not properly inserted Sewing computer is not running at room temperature Sewing computer is not switched on	Insert plug properly Use sewing computer at room temperature Switch sewing computer on (to «I»)
Embroidery process is interrupted or can not be started	e.g. upper thread broken, feed-dog not lowered etc. Embroidery software or EC on PC can not be installed	Follow the animated recommendations in the display Ask your BERNINA dealer
Thread is caught in the area of the take-up lever	Upper thread breaks	If the lower thread breaks and the thread is trapped in the area of the take-up lever, proceed as follows: <ul style="list-style-type: none"> • power switch to «0» (off) • remove the screw on the head frame with the angular Torx key • pull head frame to the left • remove remnants of thread • attach head frame and tighten screw

Embroidery

Details of the embroidery module

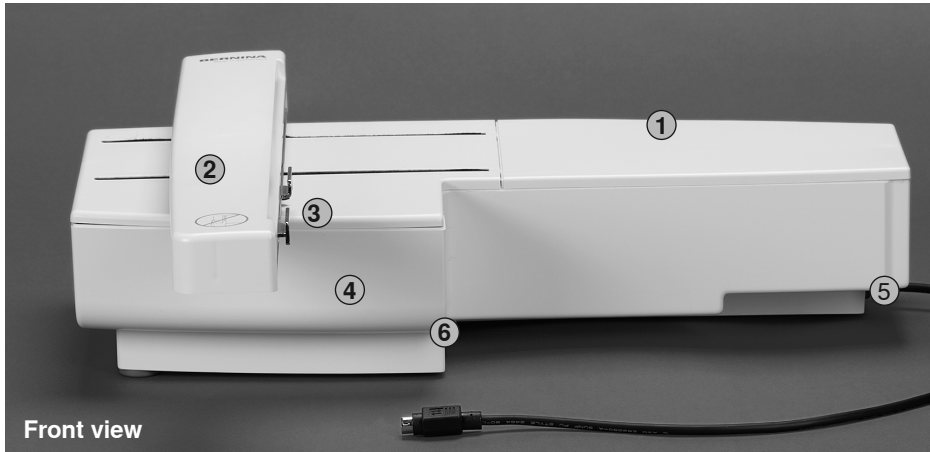

Front view

- 1 Embroidery surface
- 2 Embroidery arm
- 3 Embroidery hoop connection
- 4 Accessory box
- 5 Connecting lug right
- 6 Connecting lug center



Back view

- 7 Sewing computer connecting cable
- 8 Cable holder



The side view (handwheel) of the sewing and embroidery computer with the cable connections are shown on page 9 of the sewing computer instruction manual.

Standard accessories

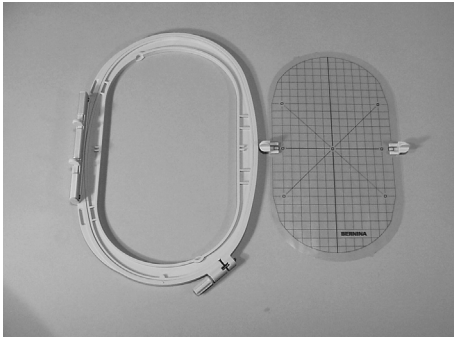

Large oval embroidery hoop
(145x255mm)
Template for embroidery hoop



Embroidery presser foot No. 26



Embroidery needle range

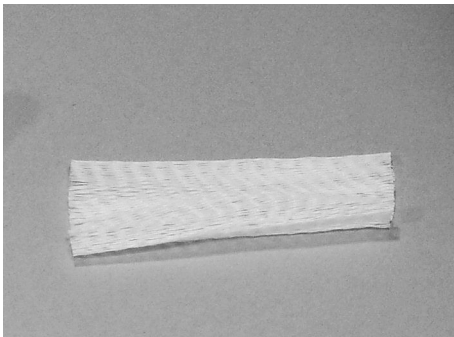

Net for upper thread spools – pull over
upper thread spool for even spooling

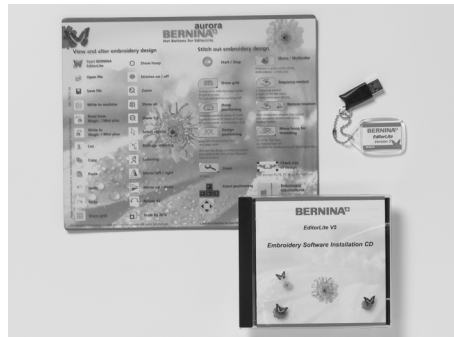

Embroidery software BERNINA /
mouse pad



USB connecting cable for PC
embroidery software



Carrying bag

Optional accessories

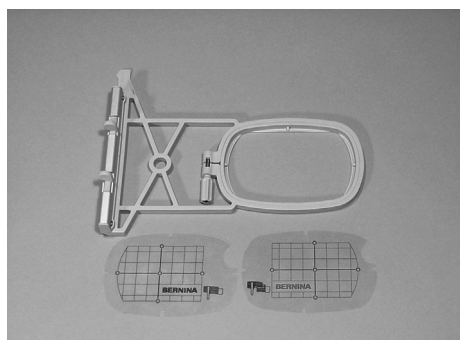

Small embroidery hoop (72x50mm)
(for normal use and free arm embroidery).
Blue template for normal use
Red template for free arm embroidery

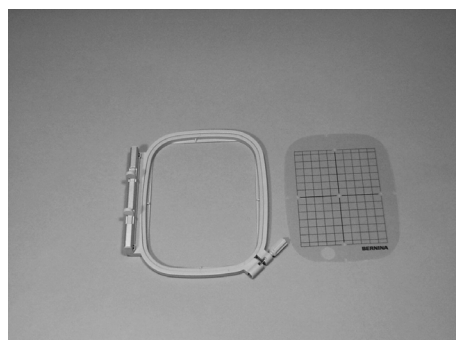

Medium embroidery hoop (100x130mm)
Template for medium embroidery hoop

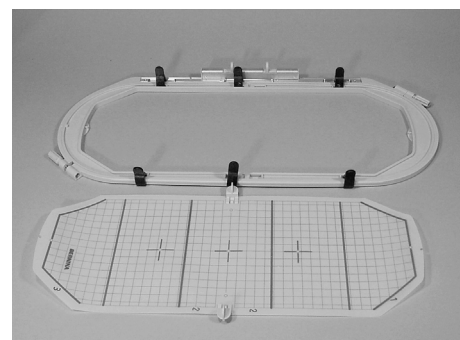

Mega-Hoop (150x400mm)
Template to Mega-Hoop

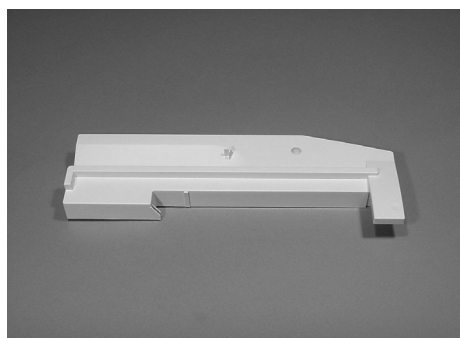

Adapter for free arm embroidery

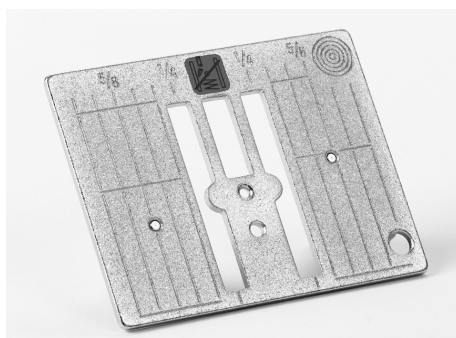

Straight stitch plate 450

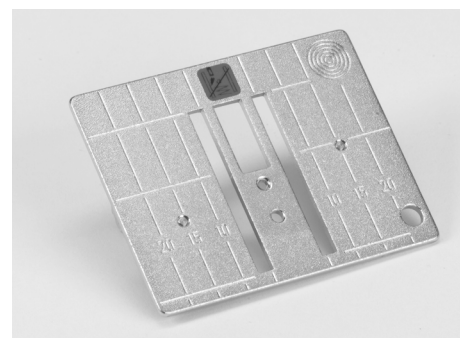

Straight stitch plate 430 / 440 QE

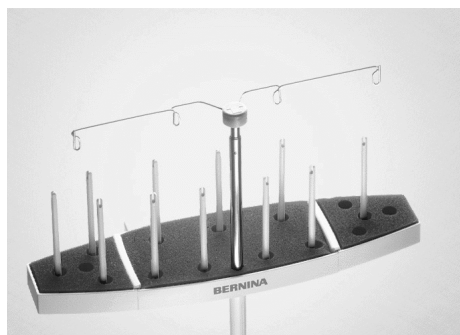

BERNINA Multiplespoolholder



BERNINA Embroidery software

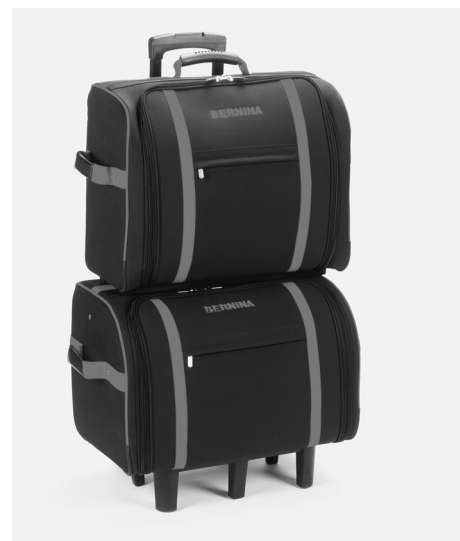

Suitcase system for sewing computer and embroidery module



BERNINA embroidery cards / Mini Box plus or Magic Box plus



BERNINA border embroidery software

Refer to the Accessories catalogue for more information on sewing, embroidery and quilting accessories or www.bernina.com

Connecting the adapter for free arm embroidery

The adapter is used for embroidering tubular items (sleeves, trousers, infant items, socks, etc.) on the free arm of the sewing computer.

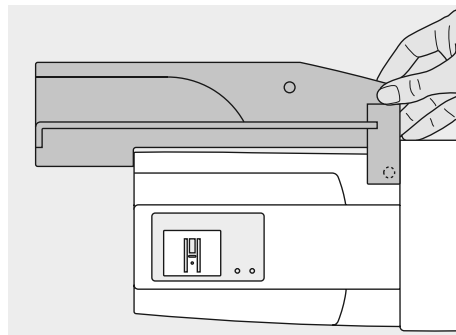
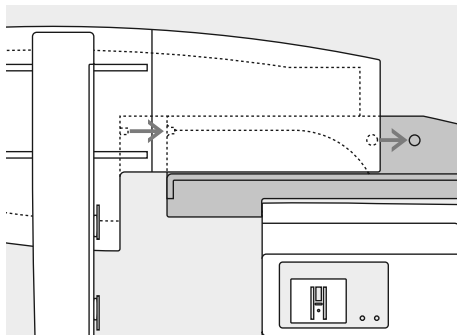
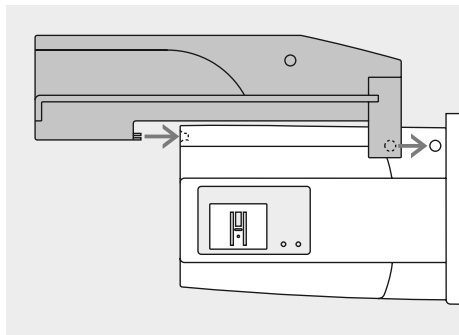

Attaching the adapter to the sewing computer

- push the adapter behind the free arm towards the sewing computer so that the connecting lugs engage in the base plate of the sewing computer

Attaching the module to the adapter

- place the module on the adapter with the front edge of the module as close as possible to the L-shaped guide on the adapter
- push the module towards the guide from the left until the connecting lugs engage in the base plate of the adapter

Removing the adapter

- remove the module from the adapter
- the rear right corner of the adapter is designed to be used as a grip
- hold the adapter with this grip and remove from the base plate of the sewing computer

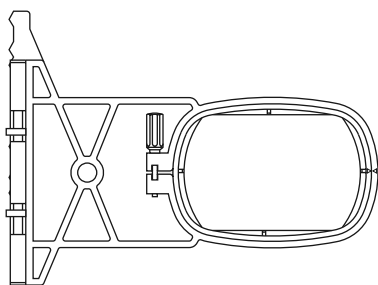

Free arm embroidery hoop

- the small, oval embroidery hoop is specially designed for free arm embroidery



Only the small hoop can be used for free arm embroidery.

Attaching the module

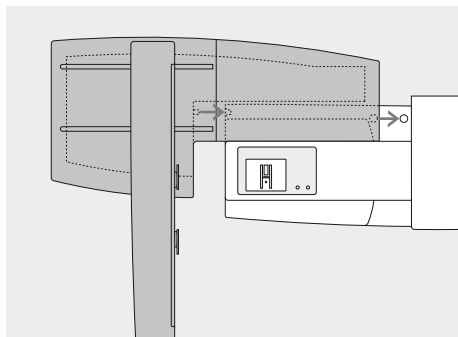

Attaching the module

- place the module on the sewing computer behind the free arm
- push the module from the left towards the sewing computer so that the connecting lugs engage in the base plate
- Unplug foot control

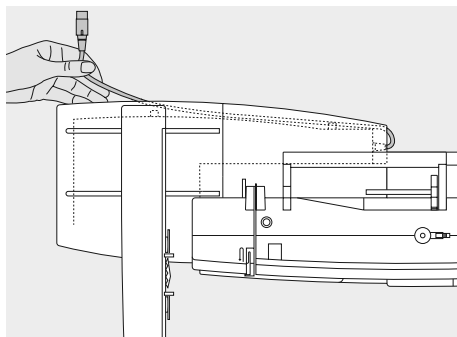

Releasing the cable

- the cable connects the module to the sewing computer
- pull the cable out of the holder on the back of the module



When connecting the embroidery module, attention must be paid that all items are on a flat and even surface!

Always separate the module and sewing computer for transportation. Never transport them attached.

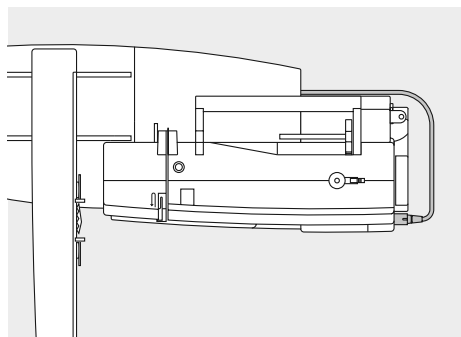

Connecting the cable

- plug with flat side to the front
- insert the plug into the socket on the right hand side of the sewing computer

Releasing the cable

- pull out the plug

Storing the cable on the module

- insert the cable into both cable holders
- press cable gently to secure

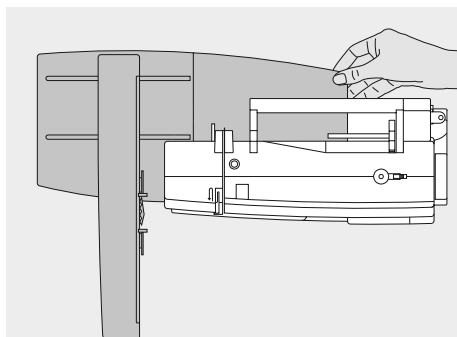

Removing the module

- grip the back right corner to lift the module and remove to the left

Preparing the embroidery computer for embroidery

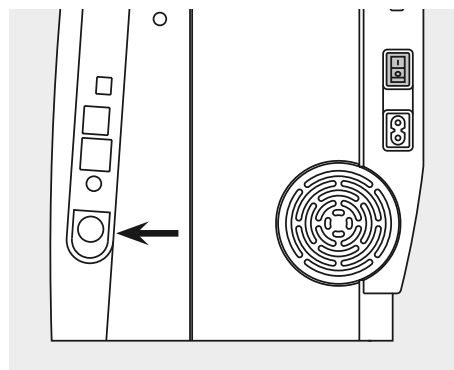
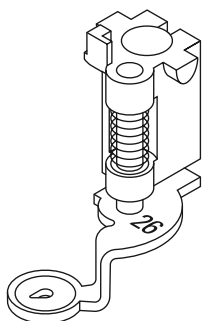

Embroidery presser foot No. 26

- attach the Embroidery presser foot No. 26
- raise the presser foot so that the embroidery hoop can be attached

Needles for embroidery

- depending on the embroidery thread use needle size 75 to 90
- use special embroidery or Metafil needle for embroidery or metallic thread
- use an undamaged needle
- raise the needle so that the embroidery hoop can be attached

Lower the feed dog

- press the button on the right side of the sewing computer to lower the feed dog

Threading upper and bobbin thread

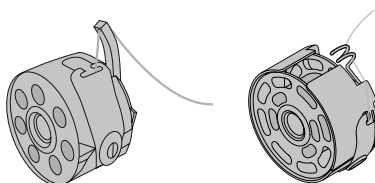
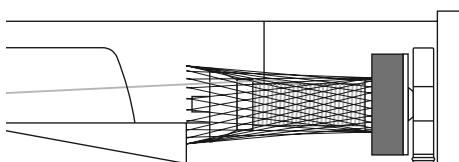

Threading the upper thread

- attach foam pad and place the upper thread spool
- slide net over upper thread spool when using sleek embroidery thread
- this prevents the upper thread from slipping and gives an even thread feed

Threading the bobbin thread

- **aurora 430 / 440 QE:** for embroidery, insert the thread into the finger of the bobbin
- **aurora 450:** thread spring guide of embroidery bobbin case when embroidering



While embroidering the bobbin can also be wound, just like in sewing.



Spool pin

When using metallic or specialty threads, using the vertical spool pin and the supplementary thread guide (optional accessory) may also help avoid problems.

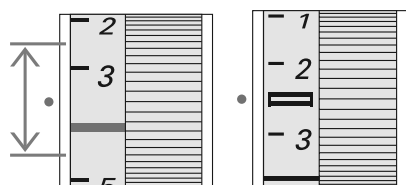

Adjusting the thread tension

The thread tension is adjusted manually.

- set the thread tension to 2.5-4.5 (aurora 430 / 440 QE) and 2.5 (aurora 450)
- adjustments for difficult or unusual fabrics can be made if necessary



BERNINA can not guarantee the stitching quality if cardboard bobbins are used.

Hooping the fabric

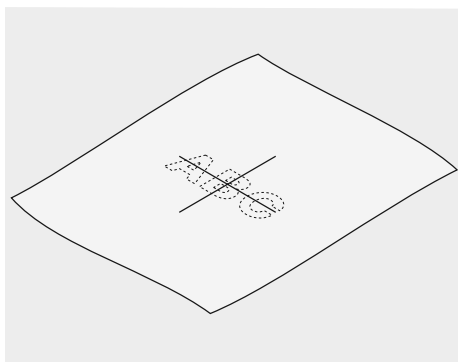

Centering

- determine the center of the fabric to be embroidered
- mark with a fabric marker or chalk

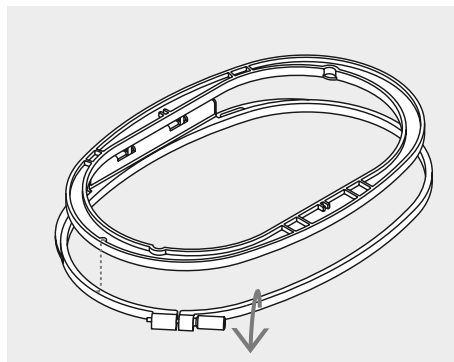

Using the embroidery hoop

- loosen the screw(s)
- remove the inner hoop
- the arrows on both hoops should match
- the arrows on the large, medium and Mega-Hoop are in the centre on the front, and the arrows on the small hoop on the right

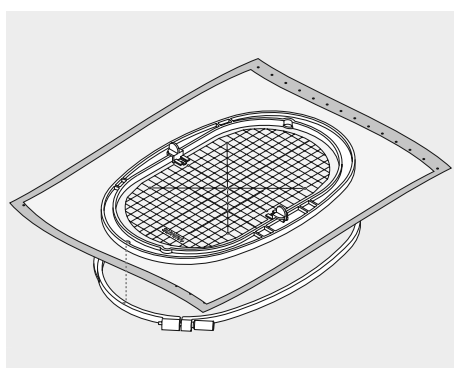
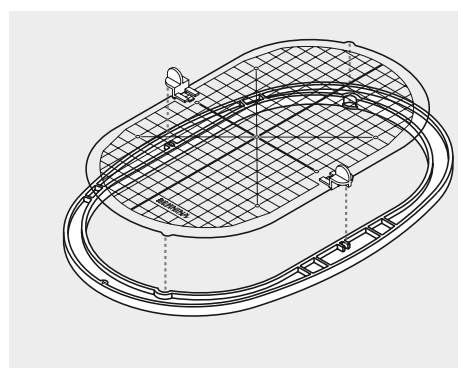

Embroidery template

- there is a template for each embroidery hoop
- the embroidery surface is marked in 3/8" (1cm) squares
- the center and corners are marked with holes for transferring marks to fabric
- place the template in the inner hoop so that the word BERNINA is at the front (by the arrows) and can be read
- the template will engage automatically in the inner hoop
- there are finger holes for removing the template from the small and medium hoops, and special attachment clips for the large hoop template

Hooping the fabric

- place fabric on top of the outer hoop
- place the marked center point in the center of the template on inner hoop
- match the arrows of inner and outer hoops
- place inner hoop on top of fabric and outer hoop and press into place, loosening screws to accommodate fabric. Tighten screws
- remove template

Embroidery stabilizers

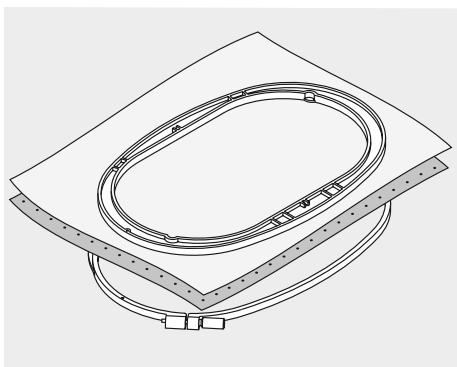

Tear-away stabilizers

- similar to interfacing; tears like paper
- one or more layers can be used
- available in different weights
- for more stability, apply to the wrong side of the fabric with temporary spray adhesive before hooping
- carefully tear away excess stabilizer from the back of the embroidery after stitching
- stabilizer will remain under larger embroidered areas

Application:

- for all wovens and non-stretchables

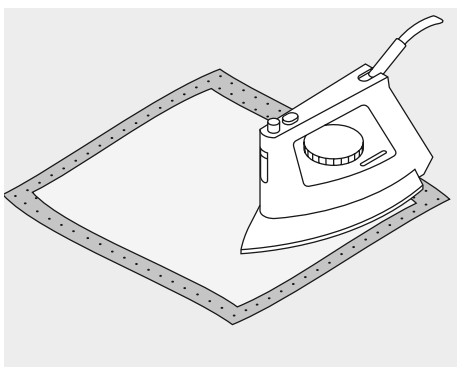

Iron-on interfacing

- must be preshrunk by soaking in warm water
- this is pressed (fused) to the wrong side of the fabric
- iron-on interfacings are available in a variety of weights and should be selected to suit the fabric being used
- removable iron-on interfacing is also available

Application:

- to provide body and shape for fabrics onto which motifs will be placed
- use in conjunction with appropriate stabilizer

Cut-away stabilizers

- one or more layers can be used
- available in light- and heavyweight
- for more stability, apply to the wrong side of the fabric with temporary spray adhesive before hooping
- carefully cut away from the back of the embroidery after stitching
- stabilizer will remain under larger embroidered areas

Application:

- for all stretchable fabrics

Paper backed adhesive stabilizer

- place stabilizer in hoop, paper side up
- use a pointed object (e.g. scissors) to score the paper and remove it to reveal the self-adhesive surface
- position the piece of fabric to be embroidered on the stabilizer

Application:

- intended for delicate fabrics such as jersey or silk, or hard to hoop fabrics such as velvets
- for pieces, sections and materials that can not be hooped



When using paper backed adhesive stabilizer make sure that there is no adhesive residue on needle, stitch plate and hook area.

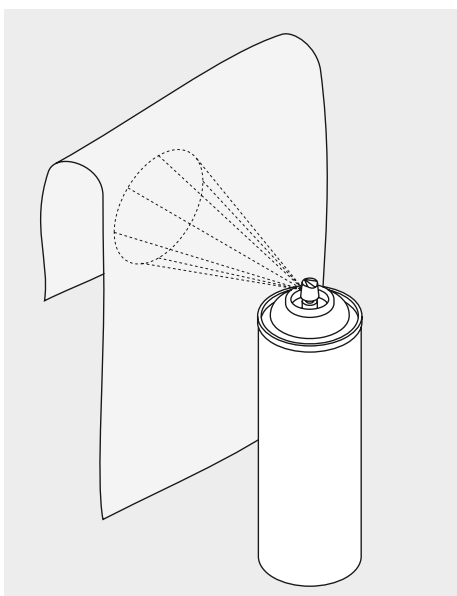

Spray adhesive

- do not use spray adhesive near or directly at embroidery computer
- use spray to stick stabilizer to wrong side of fabric for more stability
- sparingly use spray adhesive and spray form a distance of 25-30cm to stabilizer
- place fabric and sprayed stabilizer flat on each other and press together

Application:

- on stretchable fabrics and knits to prevent distortion
- appliqué: exact securing of appliqués for embroidery
- smooth fabrics: to prevent shifting
- cutwork: to fix cut-out pieces on stabilizers, e. g. pockets on trousers, collars etc.

- for fabrics that easily crush or otherwise be marked by hooping: use spray adhesive on the stabilizer, hoop the stabilizer, then fix the sections to be embroidered onto the stabilizer

Spray starch for additional stiffening

- spray starch is ideal for stiffening fine, soft or loosely woven fabrics
- spray the area to be embroidered, let dry or press gently with a warm iron
- always use an additional stabilizer such as water soluble stabilizer on the wrong side of the fabric

Application:

- ideal for fine, loosely woven fabrics, e.g. batiste, fine linen, etc.



Water soluble stabilizer for fabric with a pile and lace embroidery

- water soluble stabilizer looks like plastic wrap
- dissolve stabilizer in warm water when embroidery is complete
- water soluble stabilizers are ideal protection for fabrics with a thick or looped pile such as toweling. It also prevents the embroidery threads from sinking into the fabric or the fabric threads from poking out between the stitching
- place on top of toweling and high nap fabrics backed by appropriate stabilizer for fabric and motif
- use spray adhesive to fix stabilizer if necessary
- for fabric with a pile, reinforce with additional, suitable stabilizer on the wrong side if necessary
- for lace embroidery place one or two layers of water soluble stabilizer in hoop (as the motif is not embroidered on any fabric, only the thread embroidered motif is left)
- after dissolving lay the motif down flat and let dry
- water soluble stabilizer can also be removed by gently tearing it away when used as a topping on non-washable fabrics like velvet

Application:

- ideal for toweling, velvet, bouclé knits, etc.
- ideal for fine, sheer fabrics such as organdy, batiste, etc.
- recommended for use as a stabilizer with low stitch count motifs
- use heavier water soluble stabilizer to stitch lace motifs

Important embroidery information

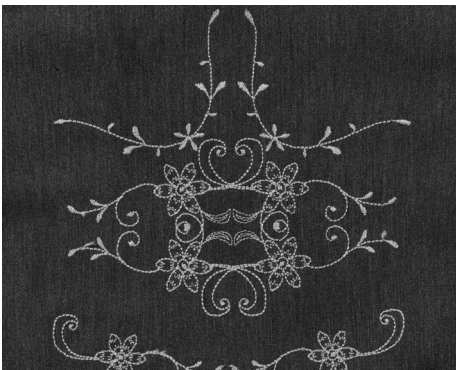

Choosing an embroidery motif

- simple motifs with a low stitch count are suitable for embroidery on fine fabric
- large-scale, densely embroidered motifs (e.g. with multiple color and embroidery direction changes) are suitable for medium- and heavyweight fabrics

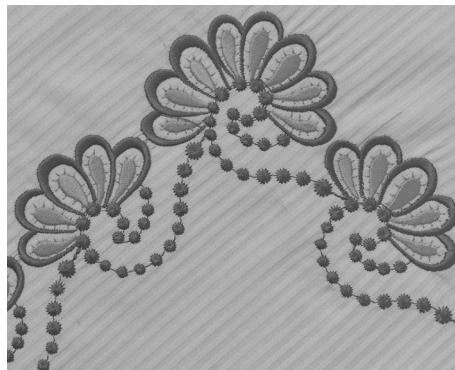

Embroidery test

- always stitch an embroidery test on a sample fabric. Adjust color, thread quality, needle, stitch density, tension, etc. to suit the motif if necessary
- for the test use the same fabric and stabilizer that you will use on the project



Scaling/Sizing motifs

- motifs can be scaled/sized with the BERNINA embroidery software on the PC
- extensive scaling up or down of motifs may lead to unsatisfactory results

Different stitch types

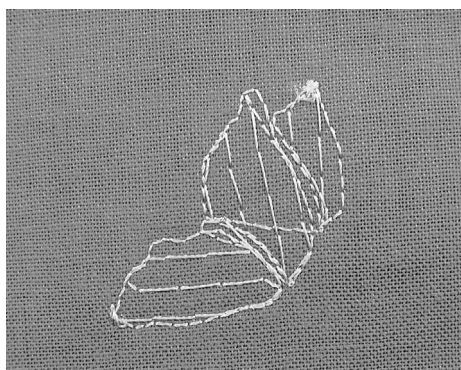

Underlay stitches

- underlay stitches are the foundation of a motif and are used to stabilize the base fabric and hold it in shape. They also prevent the covering stitches of the motif from sinking into the knit or the nap of the fabric

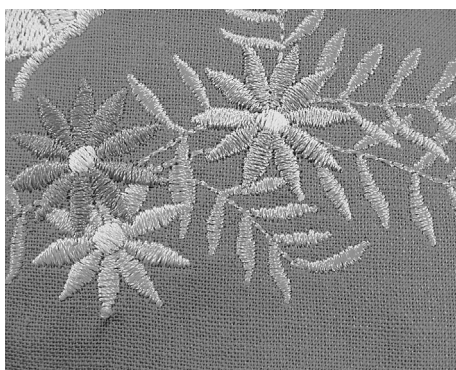

Satin stitch

- the needle moves left to right and viceversa. The result is a very dense, covering zig-zag stitching to fill the shape
- satin stitching fills are ideal for narrow and small shapes. Satin stitching is, however, not suitable for larger areas, since wide stitches are too loose and do not cover the fabric properly. In addition there is the danger that with too long stitches the threads could catch on something which would damage the embroidery

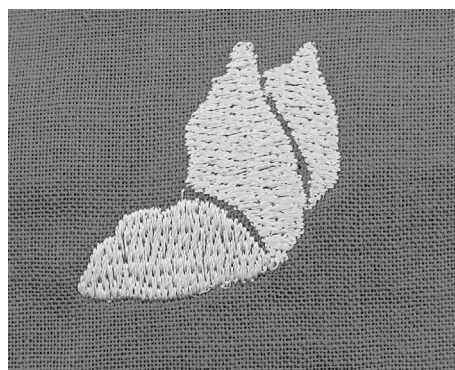

Step stitch

- a fill stitch with stitches of specified length sewn in rows used primarily to fill large areas quickly

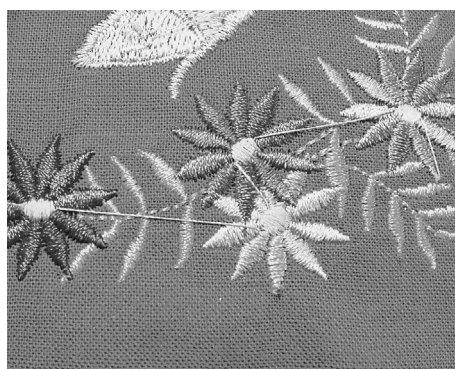
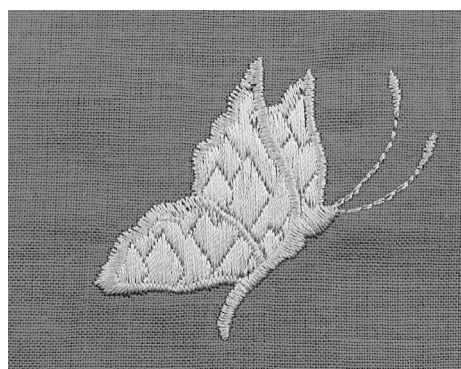

Fancy-fill stitches

- to give areas a special effect
- stitches that create a motif with an area to be filled

Outline stitches

- usually straight or satin stitches
- used to define a specific area or areas
- examples are: straight stitch, double run, triple run, satin

Jump stitches

- long stitches that skip over fabric after one part of the motif finishes and the next begins
- before and after the jump stitch securing stitches are sewn
- jump stitches are trimmed before the next color starts to embroider

Embroidery threads



One of the most important elements in successful embroidery is the quality of the thread. We strongly recommend that you purchase thread from a reputable BERNINA dealer in order to avoid irregularities, thread breakage, etc. which so often occur with poor quality threads.

Embroidery is particularly effective if you use glossy rayon or polyester embroidery threads as upper threads. They are available in a wide range of colors for beautiful embroidery.

Polyester threads

Polyester with a brilliant sheen is a hard wearing colorfast thread and has a high tensile strength. It is suitable for all types of embroidery, especially children's clothing and items which will be washed often or subject to much wear and tear.

Rayon threads

Rayon is a soft viscose fiber with a brilliant sheen and suitable for fine, delicate embroidery, or items that will not receive excessive wear and tear.

Metallic wrapped polyester thread

Metallic thread is a light- to mediumweight thread suitable for special effects in embroidery.

Embroidery needle

- correct size thread must correspond with correct size needle
- replace needle regularly



When sewing with metallic threads, we recommend the use of the vertical spool pin and the supplementary thread guide (optional accessory).



It is recommended to use a 130/705H Metafil needle and to reduce the speed.



Bobbin threads



Bobbin-Fil (special bobbin thread)

Bobbin-Fil is an especially soft and light polyester thread suitable for bobbin thread. This special bobbin thread ensures a steady thread tension and an optimal intertwining of the upper and bobbin thread. The thread produces even stitching on both, the right and wrong side of the fabric.

Darning and embroidery thread

Fine mercerized cotton thread suitable for embroidery (Mettler 60 weight suggested), which is embroidered on cotton fabric.



Use white bobbin thread or match color with fabric.

Requirements for embroidery operations

BERNINA applies the widely used USB technology to their Sewing/Embroidery systems. In order to avoid undesirable interaction between BERNINA's individual USB devices and other USB devices, BERNINA recommends taking the following precautions:

- Avoid turning the aurora Sewing/Embroidery System or other USB devices on and off in short intervals.
- When using an embroidery software with dongle, do not unplug the dongle while the software is running!
- During the embroidery stitch out process, do not unplug the USB cable.
- Before turning off the aurora Sewing/Embroidery System, always close the embroidery software and then unplug the USB cable.
- If you intend to use a USB HUB device or other USB devices, BERNINA recommends using the USB Standard of Version 2.
- BERNINA recommends closing all running computer programs while embroidering with the embroidery software / EC on PC programs.

System requirements of your PC

Minimum requirements

Pentium 3 CPU, 800 MHz or higher
Windows XP Prof. and Home Service Pack 2
256MB RAM, 2 USB ports,
500MB available space
8GB Hard Disk Memory,
16 Bit True Color Graphic Card

Recommended requirements

Pentium 4 CPU, or higher
Windows XP Prof. and Home Service Pack 2
Windows Vista
512 MB RAM or higher, 2 USB ports,
20GB Hard Disk Memory,
750MB available space,
32GB or higher True Color Graphic Card

The «aurora» embroidery system is operated by the BERNINA embroidery software PC embroidery software and directly on the personal computer by the EC on PC software.*

* the term PC basically applies to PC and laptop



When the aurora Sewing/Embroidery System is in the embroidery mode, the foot control must be unplugged.

To avoid errors with embroidery via personal computer no virus scanner must be activated.

If the aurora 430 / 440 QE / 450 is connected to the computer via a USB hub, the system can cause difficulties when turning off the aurora 430 / 440 QE / 450 with running embroidery software (depending on the PC configuration). These difficulties are easily remedied by rebooting the PC. Stitching in the already started motif can be resumed at the last stitch with the function «Embroidery sequence control» and «Saved embroidery position» (see page 76).

BERNINA embroidery software

BERNINA embroidery software

The software is necessary to open and edit (rotate, scale etc.) embroidery designs.

Refer to enclosed CD-ROM for user instructions.

BERNINA EC on PC software (Embroidery Control on Personal Computer)

The PC software EC on PC will be installed automatically with embroidery software. Motifs can be positioned and embroidered with this software.

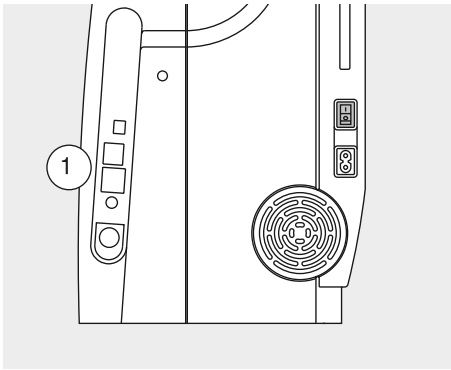

Turning on the sewing and embroidery computer

- power switch on «I» (on)
- connect the USB connection cable to the personal computer and the designated connection on the right side of the sewing computer (1)



Opening motifs

- click on the «Open» icon in the toolbar
- the "Open" menu will open. Select your files
- open the desired motif with a double-click and work on it if required



EditorLite



ArtDesign

Starting embroidery software

- double-click on the embroidery software icon on your Windows desktop or select Start / Program / embroidery software



Important

It is strongly recommended to save all relevant changes of the design before starting the stitchout process.

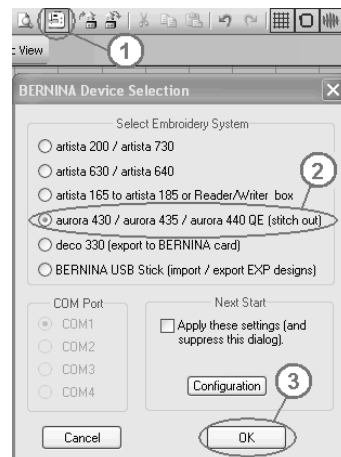

Starting to embroider

- first, REMOVE the HOOP
- click on the icon «Write to Machine» (1)
- activate the aurora models field in the opened window
- press «OK» (3)
- the software EC on PC will be started:
 - after a few seconds the embroidery module icon appears in the display of the embroidery computer
 - embroidery foot No. 26 will be displayed 
 - the embroidery module arm moves: the embroidery module is being calibrated
- attach hoop
- the needle position must now match the hoop centre (use hoop template). If not, realign the hoop (see p. 77).

Embroidery process - EC on PC

PC display

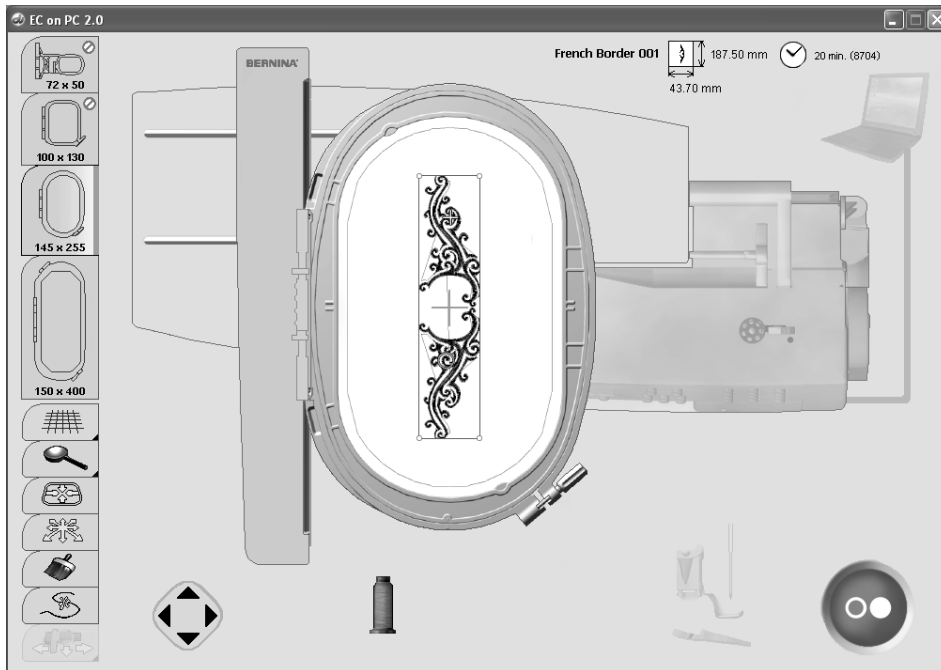

Motif

- the motif is displayed in color
- the smallest possible hoop for the selected motif is displayed
- the needle position (marked by a fine green cross) is at the start point of the first color

Displays on the PC



Connection between PC and embroidery computer

- during data transfer, the connection between PC and embroidery computer is checked
- if the connection is interrupted, a notification in red appears
- place the cursor on the red element (without a mouse click)
- an animation will start showing the user that all cable connections have to be checked



Embroidery requirements

- program checks whether:
 - the presser foot is raised (for calibration)
 - the feed dog is lowered
 - the needle is in the highest position (so that the embroidery arm can move)
 - the presser foot is lowered (for the embroidery process)
- each element which is not in the correct position will be highlighted in orange on the display

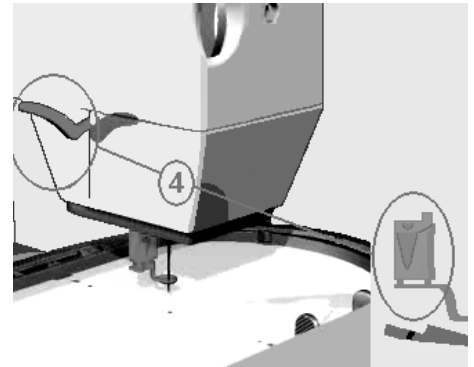

Example:

- place the cursor on the orange element (without a mouse click)
- an animation will be started showing how the element is positioned in the correct location
 - here the presser foot should be raised

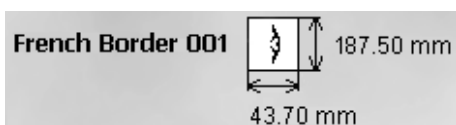

Motif size

- display of the motif name, width and height in mm

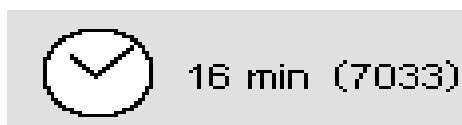

Embroidery time and stitch count

- display in minutes of the total embroidery time of the motif selected
- display of the total stitch count of the motif selected



Color summary

- each color of the motif is represented as a spool in the original color
- for more than four colors scroll through further colors with the now visible right scroll arrow



Color information / Color selection

- place the cursor on the desired color; the spool will be enlarged and the following information will be displayed:
 - thread brand / color number
 - position of the current color / total number of all colors
 - embroidery time of this color
 - total stitch count of this color
- click on the desired color
- the active color will be highlighted in color in the embroidery motif
- the embroidery hoop will move to the start point of the color selected**
- double-click on a color = the embroidery process can be started directly with this color (see also «Changing embroidery color sequence manually», page 76)



- scrolling forward though colors can be done with «F3» on the computer keyboard



- click on arrow = return to Color summary



Embroidery progress

- colors already embroidered are indicated by an empty vertical spool
- the remaining total embroidery time as well as the embroidery time of the active color will be displayed



If the embroidery process is started now, always the first color is stitched.

If the embroidery sequence of the color should be changed, you must double-click on the corresponding color or select the «Embroidery sequence control» - see page 76.



Start-Stop icon on the PC display

- is gray (inactive) if the calibration was not successful
- is blue if starting the embroidery process is possible
- click with the mouse on the icon
- the embroidery hoop will move and the hoop will be checked
- if the hoop is missing or a wrong one was attached, this will be illustrated to the user in an animation
- mouse-click on the animation, and the starting screen reappears
- during the transfer of the data from the PC to the embroidery module an hour glass is visible in the display of the embroidery computer
- as soon as the blinking Start-Stop icon is displayed, the embroidery computer is ready to embroider



- the process is confirmed and the animation closed



- the process is interrupted and the previous screen appears



- the arrow (in place of the Start-/Stop symbol) indicates that a mouse-click will take you back to the starting screen
- if the necessary requirements for the starting are met, the animation tells you that the embroidery computer is now ready to start the embroidery process by pressing the Start-/Stop button
- the embroidery process can only be stopped by pressing the Start-/Stop button on the embroidery computer

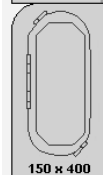
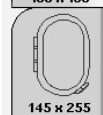

Embroidery hoop

- the recommended embroidery hoop will be highlighted on the display
- the attached embroidery hoop will be marked with a green bar
- non selectable embroidery hoops will be indicated by a «No Parking» icon
- the embroidery hoop size will be displayed in mm

Functions on the display



Show grid

1. a large cursor - a blue cross - indicates the hoop center. In addition to the blue cross, there is a green cross for the centre of Mega-Hoop position 1 and a red cross for the centre of Mega-Hoop position 3
2. the grid is now visible, the motif can be positioned better
3. the grid and the cursor are switched off



Zoom (4 levels)

- display of the motif will be enlarged by one level with each mouse click
- the fifth click will bring you back to the starting position
- user defined viewing:
 - place the cursor on the visible arrows without clicking
 - the embroidery motif is moved horizontally or vertically
- press the ctrl button simultaneously to move the motif faster



Position hoop

1. the hoop will be moved until the needle is exactly in the center of the motif
 2. the hoop will be moved until the needle is exactly in the center of the hoop, a blue point will appear in the middle of the icon
 3. the hoop will be moved until the needle is exactly on the beginning of the selected color
- this procedure can also be done with «F2» on the computer keyboard



▲ shows that the icon has several functions. These can be activated by clicking on them again.



Positioning of motif within the hoop

- this option is available when the positioning mode is active
- place the cursor on the motif (within the blue hoop)
- the cursor becomes a small hand
- left-click and drag the motif to the desired position
- release mouse button and drop the motif in place
- if the motif is positioned outside the embroidery area the color of the frame changes from blue to red
- for better positioning activate the grid if required



Note:

If the Start-/Stop button is clicked on when a motif is highlighted with a red frame, the embroidery process will not start because the motif can not be embroidered in the selected position. Move the embroidery motif first until the frame changes from red to blue.



Accurate positioning of motif in the hoop

- click on the icon with the cursor and the positioning mode will be activated
- it can also be activated with «F4» on the computer keyboard
- by clicking on the directional arrow(s) move the motif within the embroidery hoop to the desired position in small steps

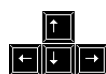

- with the four arrows on the keyboard the motif can be positioned exactly
- the embroidery motif moves by 0.2mm each time the key is pressed



- if the «Ctrl» key is pressed as well, the motif moves by 2mm



Single/Multi color motif

- if the icon is inactive, the colors will be embroidered individually, which is standard
- if the icon is active, the complete motif will be embroidered in one color without stopping
- the embroidery motif and the color information will be displayed in one color



Checking the hoop type (e.g. after hoop change)

- place the cursor on the embroidery arm
- the embroidery arm becomes blue
- by clicking on the embroidery arm the hoop will move and the attached hoop will be shown on the display

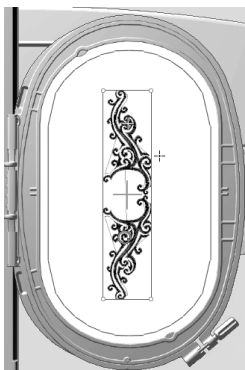

Move hoop

- the embroidery hoop will be highlighted in blue when the cursor is in the hoop
- click the mouse to move the hoop to the selected place. It moves virtually on screen and physically on the embroidery module
- the cursor indicates the needle position

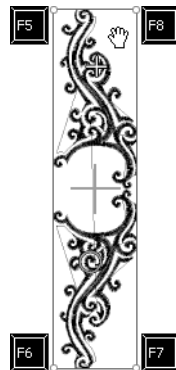

Check motif size

- check if the position of the motif and the position of the fabric match
- the corners of the frame are shown by circles
- by clicking on the circles clockwise in turn the motif stitching area is read and checked with 4 steps
- the corners can also be selected with «F5», «F6», «F7» and «F8»
- with the Mega-Hoop, use F5 to F8 to travel to the corners. Move the hoop between the upper and lower corners



Embroidery sequence control / Changing embroidery color sequence manually



1. embroidery sequence control

- the embroidery motif can be read stitch by stitch with the arrow keys
- if the «Ctrl»- key is pressed in addition, the steps will be increased to min. 10 stitches
- with «Page up = forward» or «Page down = backward» the steps will be increased to 100 stitches
- click on the symbol again: the hoop returns to the first stitch in the motif



2. embroidery process interruption in case of thread breakage / thread end

- clicking on the icon will return the embroidery hoop to the last stitch before thread breakage



Colors skipped in the sequence will be displayed as already embroidered colors by an empty vertical spool. However they can still be selected by clicking on the icon again. If the last color is not embroidered at the end, a green check appears on the Start-Stop icon after completion of the color. By clicking with the cursor on the green check, it disappears and additional colors can be embroidered.

- before re-starting go back a few stitches with the arrow keys if necessary
- 3. embroidery sequence selectable as desired
 - select function
 - click on desired thread spool



Saved embroidery position

- is only visible when the embroidery sequence control is active and the embroidery process has already started for the current motif

Resuming embroidery after interruption due to power failure:

- switch on PC and embroidery computer
- start embroidery software and EC on PC, see p. 71
- click on «Embroidery sequence control»
- clicking on the «Arrow» icon visible next to it will return the embroidery hoop to the last stitch
- before re-starting go back a few stitches manually if necessary



Moving the hoop for threading upper and bobbin thread

- the hoop can be moved in case it interferes when threading the needle (e.g. when rethreading after thread break or color change)

Position 1:



- mouse-click the symbol or press «F9»
- the hoop moves to the centre, so that the needle is in the hoop centre
- rethread upper thread

Position 2:

- raise presser foot
- mouse-click the symbol again or press «F9»
- the hoop travels to the far left position
- the bobbin can now be replaced or refilled
- click on the Start-/Stop or the hoop moving function symbol or press F9 to move the hoop back to its previous position to resume the stitching
- press the Start-/Stop button to continue embroidering



The embroidery module must be calibrated before the initial application.

Checking if needle and hoop centre match (only with oval hoop)

- this becomes necessary if the actual hoop centre does not match the hoop centre as displayed in the screen
- hoop adjustment has to be done only once as it is valid for all embroidery hoops
- place the template in the hoop
- press «F12» button
- select the oval attached hoop
- place the center of the template with the arrow keys exactly underneath the needle
- press the «shift» key (keep depressed)
- click with the mouse on the now visible icon (next to the «Position hoop» icon)
- the adjustment will be saved

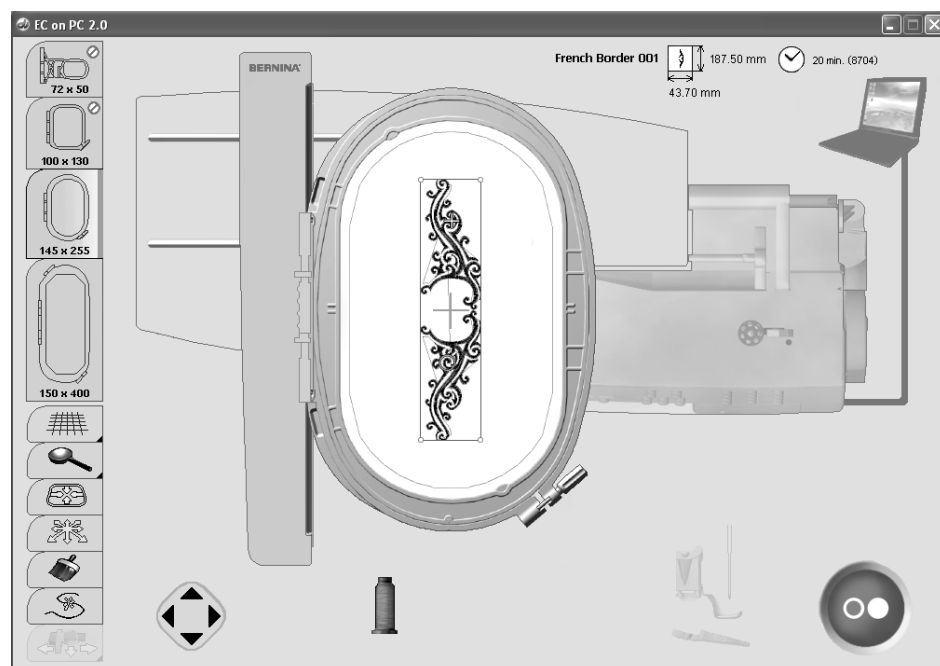

Connection error

If the connection is interrupted during the embroidery process the PC and the cable become **red**.

Provided that the USB cable is correctly plugged in and the connection is not re-established automatically (PC and cable gray), take the following steps:

- close the EC on PC application by clicking on «close» or by «Alt F4»
- check all cables
- switch off sewing and embroidery computer and switch it on again
- disconnect USB cable and plug it in again
- switch PC off and on again
- re-start EC on PC by clicking on «Write to Machine»
- click on «Saved embroidery position» (see Saved embroidery position, page 76)



Attaching the embroidery hoop

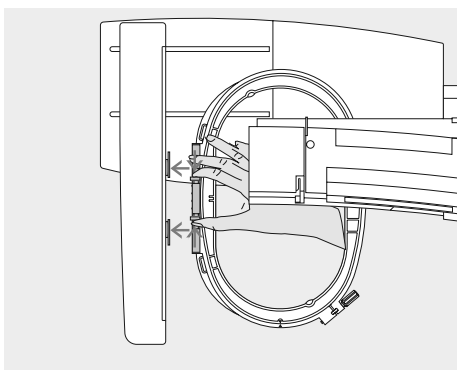

Attaching the embroidery hoop

- raise needle and embroidery presser foot
- hold the hoop with the right side of the fabric up and the attaching mechanism to the left
- pass the hoop under the embroidery presser foot
- squeeze the ends of the attaching mechanism on the side of the hoop
- position the center points of the hoop (small attachment clamps) over the bracket of the embroidery arm
- push the hoop down until it engages
- release the attaching mechanism of the hoop

Removing the hoop

- press both ends on the hoop attaching mechanism towards each other
- pull up to remove the hoop

Starting to embroider

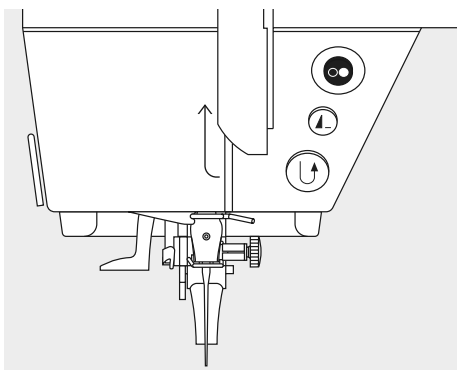

Starting to embroider with the Start-Stop button on head frame

- lower the presser foot
- keep the Start-/Stop button pressed
- the embroidery computer will sew approx. 7 stitches and stop automatically
- raise the presser foot
- cut the thread tail at the beginning of motif
- lower the presser foot
- press the Start-/Stop button to resume the stitching

Interrupting embroidery

- press the Start-/Stop button during embroidering
- the embroidery computer will stop immediately
- the animation that appears can shift when activated
- some of the functions can now be selected again, or press the blue return arrow to return to the starting screen

Completing the color

- lower the presser foot again
- press the Start-/Stop button again
- the embroidery computer embroiders all the sections in the activated color
- the embroidery computer stops automatically when complete

Changing color

- the embroidery computer is automatically ready to embroider the next color
- change color of the upper thread accordingly
- embroider with the new color

Cutting thread ends after embroidery

- raise the presser foot
- remove the embroidery hoop from the embroidery arm
- cut threads and any connecting threads close to the motif
- take care that the bobbin thread is not cut too closely to the stitch plate when removing the embroidery hoop. This prevents tangling when starting again

Mega-Hoop (special accessory)

Open or create motif

- open a motif (refer to page 71 on how to open a motif)
- the «Mega-Hoop» file contains Mega-Hoop-compatible stock designs. Select one and edit it if wished
- or create your own Mega-Hoop designs

Starting the embroidery process

- refer to page 71 on how to start embroidering

Repositioning the Mega-Hoop

- an animated symbol appears when it is time to reposition the hoop
- raise the presser foot
- press the front push button on the hoop and move the hoop to the indicated position

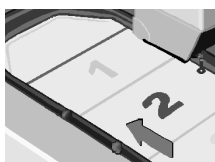

Repositioning the Mega-Hoop into

Position 1:

- carefully move the hoop until it engages into position 1 (top)

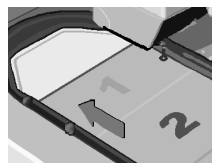

Position 2:

- pull or push the hoop until it engages into position 2 (centre)



Position 3:

- carefully move the hoop until it engages into position 3 (bottom)

Checking the hoop position

- click the tick in the animated symbol or press the Start-/Stop button on the embroidery computer to complete the repositioning of the hoop
- the hoop moves = the hoop position is being checked
- press the Start-/Stop symbol in the display to continue the embroidery

Removing the Mega-Hoop

- move the hoop into position 2
- press the two push buttons at the hoop coupling together and lift hoop out



Upper thread

After repositioning the hoop, the upper thread must be tightened by rewinding the spool a little by hand.

Embroidering borders

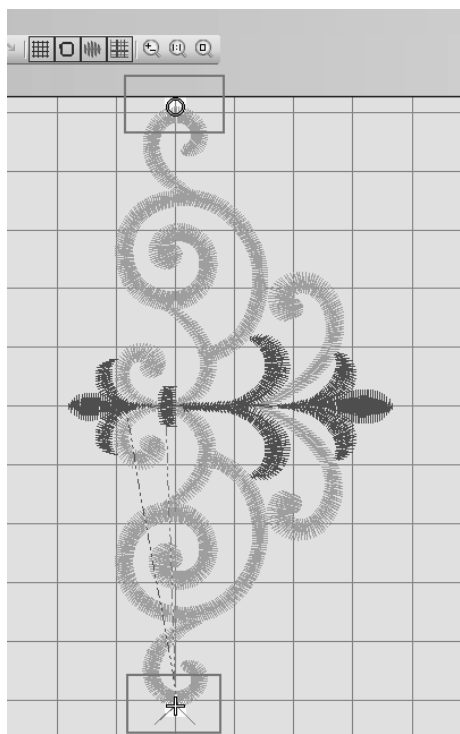

A border can either consist of several small motifs or long sequenced designs. With continuous designs, the end point of one sequence very often is also the starting point of the next sequence. EC on PC will help you to easily find the exact joining position, even if the fabric needs rehooping.

Preparation:

With border embroidery, a line along the border is usually marked on the fabric. Use the template to hoop the fabric, matching the marked line with one of the vertical lines on the template.

Embroidering:

- start embroidery software
- open the design
- the start of the design is marked with a circle and



the end with a cross



- mark the starting point of the design on the fabric as required
- click the «Write to Machine» symbol to start EC on PC



Moving the hoop

- click the area within the hoop to move the hoop - on-screen and physically - to the selected place. The new needle position (green cross) is displayed (clicked place = needle position)



use the arrow keys to position the hoop:
move it until the needle is exactly on the selected point

Positioning the motif:



- click on the zoom symbol until the motif can be easily viewed in the screen



- click «Move motif» symbol
- move the motif until the green cross (needle position) and the motif starting point (circle) match (see p. 75)

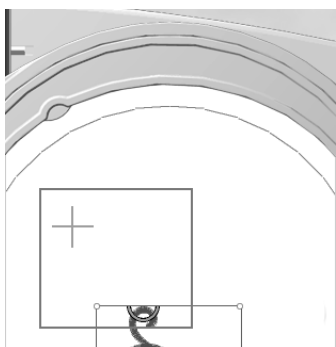

use the arrow keys on the keypad to accurately position the motif

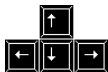

Note:

If the starting and end point of a motif are in the centre, they can be redefined in embroidery software (refer to user instructions p. 259)

Summary stitches

aurora 430

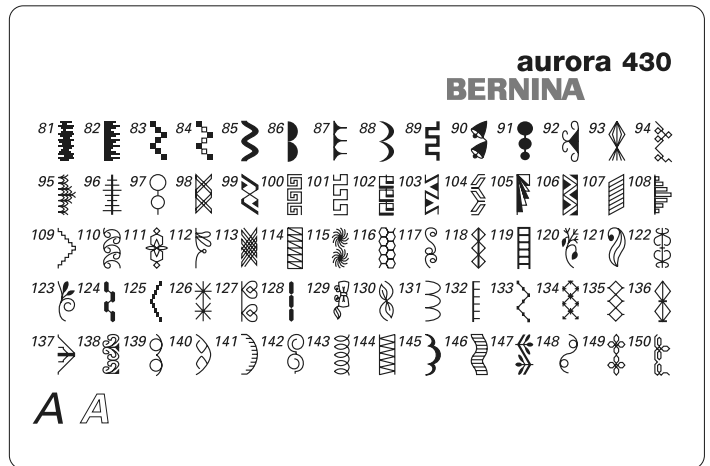
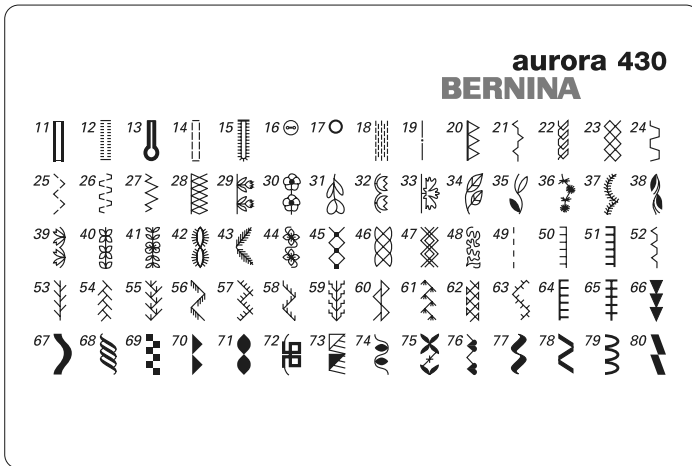

1 - 28 Practical stitches

- 1 Straight stitch
- 2 Zig-zag
- 3 Vari-overlock
- 4 Running stitch
- 5 Securing stitch
- 6 Triple straight and triple zig-zag
- 7 Blindstitch
- 8 Double overlock
- 9 Super stretch stitch
- 10 Standard buttonhole
- 11 Narrow buttonhole
- 12 Stretch buttonhole
- 13 Keyhole buttonhole
- 14 Straight stitch buttonhole
- 15 Hand-look buttonhole
- 16 Button sew-on program
- 17 Straight stitch eyelet
- 18 Darning program
- 19 Basting stitch
- 20 Reinforced overlock
- 21 Gathering stitch
- 22 Jersey stitch
- 23 Honeycomb stitch
- 24 Universal stitch
- 25 Sewn-out zig-zag
- 26 Lycra stitch
- 27 Stretch stitch
- 28 Knit overlock

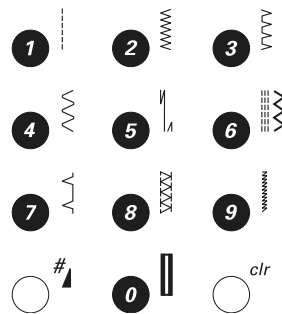

29 - 44 / 66 - 150 Decorative stitches

45 - 65 Quilt stitches

aurora 440 QE

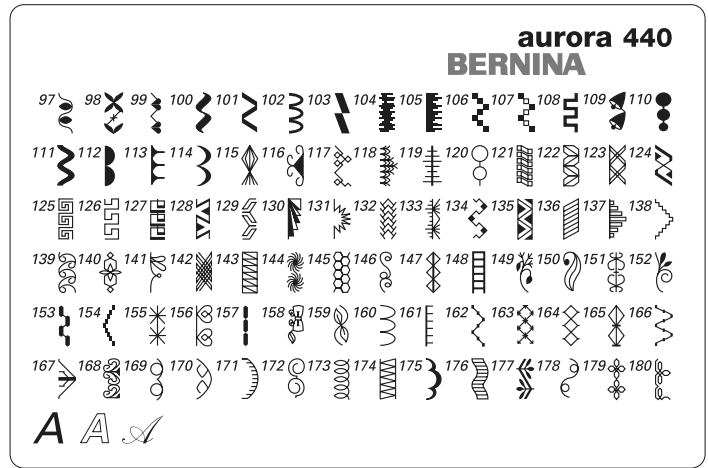
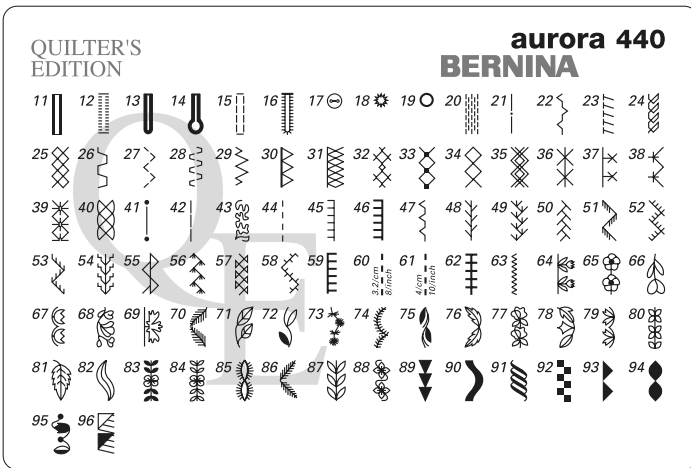

1 - 31 Practical stitches

- 1 Straight stitch
- 2 Zig-zag
- 3 Vari-overlock
- 4 Running stitch
- 5 Securing stitch
- 6 Triple straight and triple zig-zag
- 7 Blindstitch
- 8 Double overlock
- 9 Super stretch stitch
- 10 Standard buttonhole
- 11 Narrow buttonhole
- 12 Stretch buttonhole
- 13 Round buttonhole
- 14 Keyhole buttonhole
- 15 Straight stitch buttonhole
- 16 Hand-look buttonhole
- 17 Button sew-on program
- 18 Narrow zig-zag eyelet
- 19 Straight stitch eyelet
- 20 Darning program
- 21 Basting stitch
- 22 Gathering stitch
- 23 Stretch overlock
- 24 Jersey stitch
- 25 Honeycomb stitch
- 26 Universal stitch
- 27 Sewn-out zig-zag
- 28 Lycra stitch
- 29 Stretch stitch
- 30 Reinforced overlock
- 31 Knit overlock

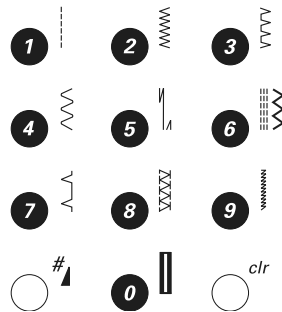

32 - 63 Quilt stitches

64 - 180 Decorative stitches

aurora 450

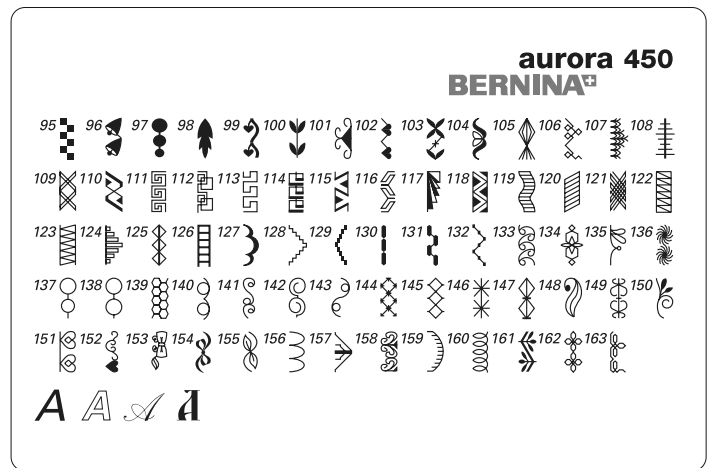
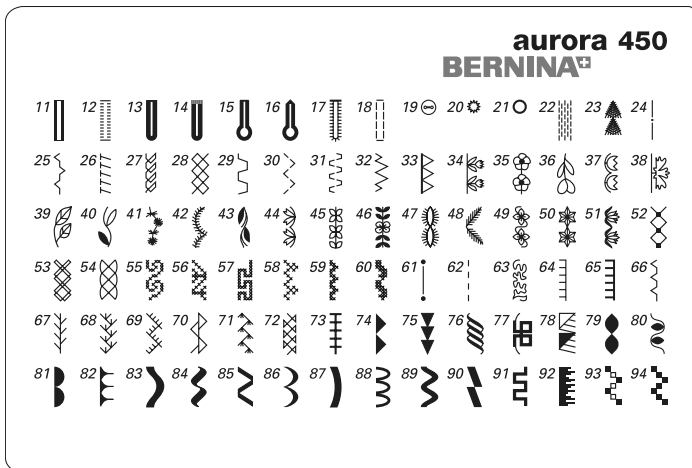

1 - 33 Practical stitches

- 1 Straight stitch
- 2 Zig-zag
- 3 Vari-overlock
- 4 Running stitch
- 5 Securing stitch
- 6 Triple straight and triple zig-zag
- 7 Blindstitch
- 8 Double overlock
- 9 Super stretch stitch
- 10 Standard buttonhole
- 11 Narrow buttonhole
- 12 Stretch buttonhole
- 13 Round buttonhole
- 14 Round buttonhole with a square end
- 15 Keyhole buttonhole
- 16 Keyhole buttonhole with a tapered end
- 17 Heirloom buttonhole
- 18 Straight stitch buttonhole
- 19 Button sew-on program
- 20 Zig-zag eyelet
- 21 Straight stitch eyelet
- 22 Darning program
- 23 Large fly stitch
- 24 Basting stitch
- 25 Gathering stitch
- 26 Stretch overlock
- 27 Jersey stitch
- 28 Honeycomb stitch
- 29 Universal stitch
- 30 Sewn-out zig-zag
- 31 Lycra stitch
- 32 Stretch stitch
- 33 Reinforced overlock

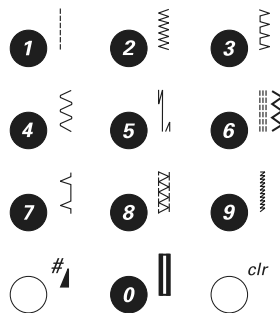

34 - 60 / 74 - 163 Decorative stitches

61 - 73 Quilt stitches

Index

- A**
- Accessories**
- Box 6
 - Embroidery 60-62
 - Sewing 5-7
 - Software 70
- Adapter 62**
- Altering stitches**
- Buttonholes 48
 - Decorative stitches 43
 - Display 23
 - Stitch length 24
 - Stitch width 24
- Automatic buttonhole**
- Automatic buttonhole foot with slide 3A 5
 - Programming buttonholes 55
- B**
- Balance**
- Buttonholes 51
 - In Memory 29
 - Practical and decorative stitches 22
- Basting stitch 42**
- Blind hem**
- Presser foot 5
 - Sewing 42
- Bobbin winder pre-tension 9**
- BSR**
- Activating BSR function 45
 - Beeper 46
 - Deactivating 47
 - Free motion quilting 46
 - Functions 46
 - Sewing 47
- Buttonholes**
- 4-step standard 53
 - 5-step keyhole 53
 - Automatic buttonhole 54-55
 - Automatic buttonhole foot with slide 3A 5
 - Balance 51
 - Buttonhole in long term memory 54
 - Corded buttonholes 49-50
 - Feeding aid/compensation plate 5
 - Information 48
 - Interfacings and stabilizers 49
 - Keyhole buttonhole 55
 - Manual buttonhole 52-53
 - Overview 52
 - Overview and brief descriptions 30-32
 - Programming the length of buttonholes 55
 - Standard buttonhole 55
 - Stretch buttonhole 55
 - Thread tension 48
- Button sew-on program 56**
- C**
- Carrying bag 6**
- Carrying handle 8**
- CFL sewing light 11**
- Cleaning 57**
- Combining stitch patterns**
- Correcting in Memory 29
 - Overview of contents 26
 - Practical and decorative stitches 26
- Corded buttonholes 49-50**
- Cover**
- Thread take-up cover 9
- D**
- Darning 36-37**
- Details**
- Embroidery module 59
 - Sewing-/embroidery computer 8, 9
- E**
- EC on PC**
- Display on PC 72-74
 - Embroidery functions 75-77
 - Interrupted connection 77
 - System requirements 70
- Edge-stitching 35**
- Embroidery (EC on PC)**
- Display on PC 72-74
 - Embroidery presser foot 64
 - Embroidery stabilizers 66-67
 - Free-arm embroidery 62
 - Needles 19
 - Optional accessories 61-62
 - Preparing 64
 - Stabilizers 66-67
 - Stitch types 68
 - Thread tension 64
 - Threads 69
 - Trouble shooting 58
- Embroidery designs**
- Functions 75-77
 - Opening a design 71
 - Selecting 71
 - Single- or multicolored motifs 75
 - Zoom 75
- Embroidery module**
- Attaching/removing 63
 - Attaching/removing hoops 78
 - Details 59
 - Suitcase system (optional accessory) 61
- Embroidery process**
- Embroidery progress 73
 - Hour glass 74
 - Starting 78
- Embroidery software 61, 70-71**
- Embroidery stabilizers 66**
- Embroidery template 65**
- F**
- Fabric**
- Centering 65
 - Hooping the fabric 65
 - Needle and thread 18
- Failures**
- EC on PC 72, 77
 - Trouble shooting 58
- Feed-dog**
- Position 20
 - Raised / lowered 20
- Foam pads 5**
- Foot control 10**
- Connecting 10
 - Needle up/down 10
- Fonts 28**
- Free Hand System presser foot lifter 11**
- Functions 24-25**
- Alphabets, numbers 25
 - Balance 24
 - Clear 24
 - Memory 24
 - Mirror image 24
 - Needle positions 24
 - Needle stop up/down 24
 - Pattern begin 24
 - Pattern end, Pattern repeat 25
 - Pound key 25
 - Reverse sewing 25
 - Securing 24
 - Speed control 24
 - Start-Stop 25
 - Stitch length 24
 - Stitch pattern 25
 - Stitch width 24
- G**
- Grid (guiding lines) 75**
- H**
- Hand-look quilt stitch 44**
- Handwheel 9**
- Height compensating plates 5, 21**
- Heirloom buttonhole 32**
- Hoops**
- Attaching/removing 78
 - Display 74
 - Hooping 65
 - Hooping the fabric 65
 - Mega-Hoop 79-80
 - Move hoop function 76
 - Optional accessories 61
 - Positioning 76
 - Selecting 74
 - Template 65
- L**
- Lens set 7**
- List of contents 3**
- Long time Memory 54**
- Lower thread**
- Accessories 5
 - Embroidery bobbin case 64
 - Inserting the bobbin 15
 - Removing the bobbin case 16
 - Winding the bobbin 15
- Lubricating 57**
- M**
- Maintenance (cleaning, lubricating, servicing) 57**
- Memory**
- Correcting in Memory 29
 - Display 23

Leaving Memory	29	BSR	5, 45	Stabilizer	49
Programming alphabets	28	Changing the presser foot	17	Stitch patterns	
Programming practical and decorative stitches	26	Presser foot pressure	22	Display	23
Samples	27	Standard accessories	5	Overview	81-83
Mirror image				Selecting	29
Display	23	Q		Stitch plate	
Mirror image (left/right) function button	24	Quilting		Attaching/removing	20
		Free-motion quilting	44	Cleaning	57
		Quilting stitches	44	Optional accessories	7, 61
		Quilting with BSR	45		
		Stipple quilting	44	T	
N				Thread	
Needle		R		Embroidery related	69
Changing the needle	16	Reinforced overlock	32	Information	18
Embroidery	60, 64	Running stitch		Threading	
Holder	8	Practical stitch	30	Lower thread	15, 64
Information	18, 19	Presser foot	5	Twin and tripple needle	13
Needle stop up/down	24			Upper thread	12, 64
Needle summary	19	S		Thread cutter	9, 14, 15, 16
Needle up/down	24	Satin stitch	68	Thread guide	8
Setting the needle position	8, 24	Safety instructions	2	Thread take-up	8
Threading	14	Save, Memory	26-29	Thread take-up cover	8
Twin and triple needle	13	Alphabets	28	Thread tension	
Needle system	18	Correcting in Memory	29	Buttonholes	48
		Deleting in Memory	29	Embroidery	64
		Function buttons	24-25	Tension adjusting wheel	9
		Numbers	28	Tension disc	13
		Opening in Memory	26	Upper thread	17
		Programming	26-28	Trouble shooting	58
		Samples	27	Triple straight stitch	34
		Temporary altered stitch memory	33	Twin and triple needle	
				Threading a twin/triple needle	13
		Screen			
		Display	23	U	
		Cleaning	57	Underlay stitch	68
		Seam guide (presser foot)	5, 35	Upper thread	
		Seam guide on slide-on table	11	Threading	12, 64
		Settings		Upper thread tension	17, 64
		Balance	22		
		Presser foot pressure	22	V	
		Thread tension	17	Vari-Overlock	39
		Setting up the sewing-/embroidery computer			
		Embroidery module	63-67	W	
		Sewing computer	10-17	Winding the bobbin	15
		Sewing			
		Accessories	5-7	Z	
		Function buttons	24-25	Zig-zag stitch	38
		Letters (Alphabets)	25, 28	Zipper	41
		Reverse sewing	25		
		Sewing corners	21		
		Sewing stitch combinations	26-28		
		Sewing with BSR	45		
		Special characters	25		
		Using compensating plates	21		
		Sewing light (CFL light)	11		
		Sewing-on elastic	38		
		Sewing speed			
		Foot control	10		
		Speed control	24		
		Slide-on table	11		
		Spool discs	5		
		Spool pin			
		Horizontal spool pin	12		
		Supplementary spool pin	13, 14		

